

ISSN 1346-7328

国総研資料 第123号

平成 15 年 9 月

ISSN 0386-5878

土木研究所資料 第3912号

平成 15 年 9 月

第 2 回

日米水道水質管理及び下水道技術に関する政府間会議 報告書

PROCEEDINGS OF THE 2ND JAPAN - U.S. GOVERNMENTAL CONFERENCE ON
DRINKING WATER QUALITY MANAGEMENT AND WASTEWATER CONTROL

2002年10月21日～24日

東京・三田共用会議所

October 21-24, 2002

Mita Kaigisho, Tokyo, Japan

国土交通省 国土技術政策総合研究所

National Institute for Land and Infrastructure Management,
Ministry of Land, Infrastructure and Transport

独立行政法人土木研究所

Public Works Research Institute, Independent Administrative Institution

Copyright © (2003) by N.I.L.I.M.

All rights reserved. No part of this book may be reproduced by any means, nor transmitted, nor translated into a machine language without the written permission of the Director General of N.I.L.I.M.

この報告書は、国土技術政策総合研究所長の承認を得て刊行したものである。したがって、本報告書の全部又は一部の転載、複製は、国土技術政策総合研究所長の文書による承認を得ずしてこれを行ってはならない。

Copyright © (2003) by P.W.R.I.

All rights reserved. No part of this book may be reproduced by any means, nor transmitted, nor translated into a machine language without the written permission of the Chief Executive of P.W.R.I.

この報告書は、土木研究所理事長の承認を得て刊行したものである。したがって、本報告書の全部又は一部の転載、複製は、土木研究所理事長の文書による承認を得ずしてこれを行ってはならない。

第 2 回 日米水道水質管理及び下水道技術に関する政府間会議 報 告 書

PROCEEDINGS OF THE 2ND JAPAN - U.S. GOVERNMENTAL CONFERENCE ON
DRINKING WATER QUALITY MANAGEMENT AND WASTEWATER CONTROL

国土交通省 国土技術政策総合研究所 下水道研究部
Water Quality Control Department, National Institute for Land and Infrastructure Management,
Ministry of Land, Infrastructure and Transport

独立行政法人土木研究所 リサイクルチーム／水質チーム
Recycle Team & Water Quality Team,
Public Works Research Institute, Independent Administrative Institution

概 要：

この報告書は、2002年10月21日～24日に東京・三田共用会議所で行われた「第2回日米水道水質管理及び下水道技術に関する政府間会議」における議事録及び講演資料等を取りまとめたものである。同会議では、日米の政府・自治体・研究機関の代表者により、水道水質管理及び下水道技術に関する両国の現状と課題について発表と意見交換が行われた。

キーワード：水道水質管理、下水道技術、流域管理、二国間協力

Synopsis：

This publication contains the proceedings of the 2nd Japan - U.S. Governmental Conference on Drinking Water Quality Management and Wastewater Control, which was held at Mita Kaigisho, Tokyo, during 21-24 October 2002. In this Conference, current status and subjects of drinking water quality management and wastewater control were presented and discussed by government and municipal officials and researchers of Japan and U.S.

Key words: Drinking Water Quality Management, Wastewater Control,
Watershed Management, Bilateral Cooperative Research



目 次

1. はじめに	1
2. 経 緯	1
3. 会議開催の意義	1
4. 日程および参加者	2
5. 会議の概要	5
5.1 開 会	
5.2 上下水道事業の概要	
5.3 水道水質規制の現状と動向	
5.4 水道水源の水質管理／雨水流出	
5.5 上下水道技術の課題	
5.6 水質検査の品質保証 (QA/QC)	
5.7 砒素に関する問題	
5.8 水質管理と微生物	
5.9 内分泌かく乱化学物質	
5.10 水の安全の課題／耐震設計	
5.11 新しい水処理技術	
5.12 地球環境問題への対処	
5.13 民営化に関する課題	
5.14 下水処理水の再利用	
6. 会議の総括	14
7. 視察の概要	15
8. おわりに	15
別添 1 第2回日米水道水質管理及び下水道技術に関する政府間会議記者発表資料	16
別添 2 第2回日米水道水質管理及び下水道技術に関する政府間会議日程 (英文).....	17
別添 3 第2回日米水道水質管理及び下水道技術に関する政府間会議参加者名簿 (英文).....	20
別添 4 第2回日米水道水質管理及び下水道技術に関する政府間会議会議要録 (英文).....	26
別添 5 曾小川日本側代表団長 (下水道分野) 歓迎挨拶 (英文).....	28
別添 6 会議および視察の写真	30

発表論文等

1. Overview of Drinking Water Quality Management 31
厚生労働省健康局水道課 谷 津 龍太郎
2. Sewage Works Development in Japan 43
国土交通省都市・地域整備局下水道部 藤 木 修
3. Overview of Drinking Water Quality Management and Wastewater Control 59
Sally C. Gutierrez, National Risk Management Research Laboratory, USEPA
4. Current and Future Regulatory Activities in Japan 69
厚生労働省健康局水道課 岸 辺 和 美
5. United States Drinking Water Regulation 79
Jennifer McLain, USEPA
6. Dioxins in Water Sources and its Risk Assessment of Drinking Water 83
北海道大学大学院工学研究科 眞 柄 泰 基
7. Present Status of Combined Sewer Overflow and New CSO Control Policy in Japan 95
国土交通省国土技術政策総合研究所 森 田 弘 昭
8. Watersheds, Stormwater, Source Water Protection 115
Tyler Richards, Water Environment Research Foundation
9. Research Agenda in Drinking Water / Wastewater Control 121
国立保健医療科学院 国 包 章 一
10. Research Agenda for Wastewater in Japan 131
国土交通省国土技術政策総合研究所 高 橋 正 宏
11. AWWA Research Foundation Advancing the Science of Water 145
James F. Manwaring, AWWA Research Foundation
12. QA/QC for the Monitoring of Drinking Water Quality 177
国立医薬品食品衛生研究所 安 藤 正 典
13. Occurrence, Treatment and Costs of Complying with the Arsenic Rule in El Paso, Texas
Edmund G. Archuleta, El Paso Water Utilities 191
14. Safe Drinking Water Lessons to be Learned from Recent Large-scale Waterborne Outbreaks
of Cryptosporidium 199
国立感染症研究所 遠 藤 卓 郎
15. Management of the Health Risks Posed by Cryptosporidium in Sewage 209
国土交通省国土技術政策総合研究所 山 下 洋 正
16. A Proactive Microbial Control in Philadelphia 221
Jung J Choi, Philadelphia Water Department
17. Endocrine Disrupting Chemicals 237
国立保健医療科学院 国 包 章 一
18. Endocrine Disruptors in Sewage Treatment Plants Summary of three-year nationwide survey and
research at PWRI 245
独立行政法人土木研究所 田 中 宏 明
19. Evaluation of Drinking Water Treatment Technologies for Removal of Endocrine Disrupting
Compounds 273
Kathleen Schenck, USEPA

20. Security Measures Against Terrorism and Seismic Reinforcement Measures of Existing Buried Large-Diameter Pipeline in Tokyo	279
東京都水道局	牧田嘉人
21. Strategies for Critical Infrastructure Protection	291
Steve Clark, USEPA	
22. New Trends of Water Treating Technology On Research for Development of High-efficiency Purification Technology (ACT21)	295
(財)水道技術研究センター	林秀樹
23. New Trend of Advanced Wastewater Treatment (biotechnology / membranes)	307
日本下水道事業団	渡部春樹
24. New Treatment Trends : Membranes and Biotechnology	323
John Novak, Virginia Polytechnic Institute & State University	
25. Global and Environmental Considerations in Drinking Water Supply (Climate Impact / Energy Savings)	329
阪神水道企業団	佐々木隆
26. Global and Environmental Considerations in Drinking Water Supply and Wastewater Control (Climate Impact / Energy Savings)	343
東京都下水道局	竹島正
27. Global and Environmental Considerations in Drinking Water Supply and Wastewater Control (Climate Impact / Energy Savings)	357
James Goodrich, USEPA	
28. Privatization of Water Utilities in Japan	367
(財)日本水道協会	山崎章三
29. Privatization in the US Water Industry & Factors Affecting It	381
Peter L Cook, National Association of Water Companies	
30. Procedures of Choosing Wastewater Reclamation Methods to Assure Safety Against Virus Infection	391
独立行政法人土木研究所	鈴木穰
31. Utilization of Treated Wastewater in Sapporo	403
札幌市下水道局	吉岡亨
32. Research in Water Reuse	413
Stephen T. Hayashi, Union Sanitary District	

1. はじめに

平成 14 年 10 月に、東京において、「第 2 回日米水道水質管理及び下水道技術に関する政府間会議」が開催され、日米両国の上下水道を巡る最近の課題について和やかな中にも熱心な討議が行われた。13 分野の議題に対し、日米双方から 32 編の発表があり、最終日に、討議の総括が行われ、議論の確認と次回の会議を平成 16（2004）年に米国で開催することなどが合意された。

本報告書は、今後の下水道分野における政策研究および技術開発の推進および国際協力の促進のために、日本の下水道分野から本会議に参加した国土交通省都市・地域整備局下水道部、国土交通省国土技術政策総合研究所、独立行政法人土木研究所、日本下水道事業団、東京都下水道局、札幌市下水道局が本会議の概要をとりまとめたものである。なお、水道分野の発表の概要については、とりまとめにあたり国立保健医療科学院の国包部長を初めとする水道分野の参加者のご協力をいただいた。

2. 経緯

日米両国間の水道、下水道分野の技術交流は、これまで各分野別に実施されてきた。下水道分野では、日米環境保護協力協定 (US-Japan Environmental Protection Agreement) に基づき、昭和 46（1971）年より日米下水処理技術委員会 (US-Japan Conference on Sewage Treatment Technology) を継続的に開催してきたが、平成元年に開催された第 12 回会議において、建設省土木研究所と米国環境保護庁研究所を中心とした技術交流のための日米下水道ワークショップへと変更の取り決めがなされた。これに基づき、第 1 回日米下水道ワークショップが平成 2（1990）年につくばで開催され、以後これまでに 5 回のワークショップが開催された。ワークショップでは、水質汚濁防止、都市流域の水質管理、下水の高度処理、合流式下水道の改善といった課題を中心に、技術交流、意見交換、研究成果の交換が行われている。

一方、水道分野については、日米環境保護協力協定に基づく「日米水道水質管理会合」が昭和 62 年から 4 回にわたり開催されてきた。

しかし、上下水道をとりまく最近の課題は、流域を一体としてとらえた水量・水質の管理、クリプトスポリジウムや内分泌攪乱化学物質の問題など、共通の課題や共有すべき情報が多く、上下水道関係者が一堂に会して情報、意見交換を行うことが有益である。そこで、両分野の会議を「日米水道水質管理及び下水道技術に関する専門家会議」として統合することとし、その第 1 回が平成 11（1999）年 7 月に米国コロラドスプリングスにおいて開催された。今回の第 2 回会議は、第 1 回会議における合意に基づき、日本で開催した。

3. 会議開催の意義

水道水質の管理については、平成 4（1992）年の水道水質基準の大幅見直しから 10 年が経過し、クリプトスポリジウムなど塩素耐性を有する病原性微生物や内分泌攪乱化学物質やダイオキシン、消毒副生成物などの有害化学物質等が重要な検討課題となっている。このため厚生労働省では、クリプトスポリジウム暫定対策指針の制定など課題解消に向けた検討を積極的にすすめている。また、2003 年に WHO 飲料水水質ガイドラインが全面改定されるのに合わせ、厚生科学審議会生活環境水道部会及び水質管理専門委員会において、水道の水質基準等に関して抜本的な見直しを行うための検討を始めたところである。

下水道についても、下水に含まれるおそれのあるクリプトスポリジウムをはじめとする病原性微生物や、内分泌攪乱化学物質等の下水道での制御と技術開発が、放流先水域での水道原水取水やレクリエーション利用、生態系保全のために一層重要となってきた。また、雨天時に排出される合流式下水道からの汚濁負荷の制御や下水処理水の水資源としての再利用の重要性も高まっており、これらの課題への対応には、いずれも流域管理の視点が不可欠である。

また、米国においては、1996年に安全飲料水法（Safe Drinking Water Act、SDWA）の改正が行われ、リスクアセスメントに基づく水質基準の見直しやクリプトスポリジウム及び消毒副生成物に関する規則の策定等が行われており、また、1998年には「きれいな水への行動計画（Clean Water Action Plan、CWAP）」が開始され、流域単位での水質管理方策の検討等が行われている。

この様に日米両国は、水道水質管理ならびに下水道技術の分野において、多くの共通の問題を抱えており、相互に情報を交換し、対策について議論することは、両国のみならず国際的にも意義が深く、また、上下水道が連携した流域管理を推進する観点からも重要である。

4. 日程および参加者

第2回「日米水道水質管理及び下水道技術に関する政府間会議」は、平成14（2002）年10月21日～23日の3日間にわたり東京・三田共用会議所で開催された。24日には、東京都の協力の下に三郷浄水場と有明下水処理場の視察が行われた。本会議には、米国環境保護庁国立リスク管理研究所水道・水資源部（Water Supply and Water Resources Division, National Risk Management Research Laboratory—略称NRMRL—, USEPA）部長のSally Gutierrez女史を団長とする13名の米国代表団と、日本側の曾小川久貴国土交通省都市・地域整備局下水道部長を団長とする下水道分野12名、高原亮治厚生労働省健康局長を団長とする水道側11名が参加した。参加者の所属と氏名を表1に示す。また、発表者と発表課題名を表2に示す。

表1 参加者名簿

日本側代表団 (○は団長)

【下水道側】

- 曾小川久貴 (国土交通省都市・地域整備局下水道部長)
- 藤木 修 (国土交通省都市・地域整備局下水道部流域管理官)
- 宮原 茂 (国土交通省国土技術政策総合研究所下水道研究部長)
- 高橋正宏 (国土交通省国土技術政策総合研究所下水道研究部下水道研究官)
- 森田弘昭 (国土交通省国土技術政策総合研究所下水道研究部下水道研究室長)
- 山下洋正 (国土交通省国土技術政策総合研究所下水道研究部下水処理研究室主任研究官)
- 鈴木 穰 (独立行政法人土木研究所材料地盤研究グループ上席研究員〔リサイクル〕)
- 田中宏明 (独立行政法人土木研究所水循環研究グループ上席研究員〔水質〕)
- 佐藤元志 (独立行政法人土木研究所水循環研究グループ招聘研究員〔水質〕)
- 渡部春樹 (日本下水道事業団技術開発部長)
- 竹島 正 (東京都下水道局業務部排水指導課長)
- 吉岡 亨 (札幌市下水道局建設部計画課技術開発担当課長)

【水道側】

- 高原亮治 (厚生労働省健康局長)
- 谷津龍太郎 (厚生労働省健康局水道課長)
- 岸辺和美 (厚生労働省健康局水道課水道水質管理官)
- 眞柄泰基 (北海道大学大学院工学研究科教授)
- 国包章一 (国立保健医療科学院水道工学部長)
- 安藤正典 (国立医薬品食品衛生研究所環境衛生化学部長)
- 遠藤卓郎 (国立感染症研究所寄生動物部長)
- 林 秀樹 ((財)水道技術研究センター浄水技術部長)
- 山崎章三 ((財)日本水道協会特別会員)
- 牧田嘉人 (東京都水道局総務部副参事〔特命担当〕)
- 佐々木隆 (阪神水道企業団管理部配水課長)

米国側代表団

- Mrs. Sally C. Gutierrez (USEPA 国立リスク管理研究所)
- Dr. James A. Goodrich (USEPA 国立リスク管理研究所)
- Ms. Kathleen Schenck (USEPA 国立リスク管理研究所)
- Dr. Stephen W. Clark (USEPA)
- Dr. Jennifer McLain (USEPA)
- Mr. Glenn Reinhardt (USEPA)
- Mr. James F. Manwaring (米国水道協会研究財団)
- Mr. Martin J. Allen (米国水道協会研究財団)
- Mr. Peter Cook (米国民営水道事業者協会)
- Mr. Jung Choi (フィラデルフィア市水道局)
- Mr. Edmund G. Archuleta (エルパソ市水道公社)
- Mr. Stephen T. Hayashi (ユニオン地区衛生公社)
- Prof. John Thomas Novak (バージニアポリテクニク州立大学)
- Mr. Tyler Richards (ジョージア州ギネット郡公共事業局)

※役職は全て会議時点でのもの

表 2 会議次第

会議

第1日 10月21日(月) 9:30~16:55

・ 歓迎挨拶(高原・曾小川)、開会挨拶(S. Gutierrez)

(1) 上下水道事業の概要(日本側:谷津・藤木、米国側:S. Gutierrez)

(2) 水道水質規制の現状と動向(日本側:岸边、米国側:J. McLain)

(3) 水道水源の水質管理/雨水流出(日本側:眞柄・森田、米国側:T. Richards)

(4) 上下水道技術の課題(日本側:国包・高橋、米国側:J. Manwaring)

第2日 10月22日(火) 9:30~17:00

(5) 水質検査の品質保証(QA/QC)(日本側:安藤)

(6) 砒素に関する問題(米国側:E. Archuleta)

(7) 水質管理と微生物(日本側:山下、米国側:J. Choi)

(8) 内分泌攪乱化学物質(日本側:国包・田中、米国側:K. Schenck)

(9) 水の安全の課題/耐震設計(日本側:牧田、米国側:S. Clark)

第3日 10月23日(水) 9:30~17:40

(10) 新しい水処理技術(日本側:林・渡部、米国側:J. Novak)

(11) 地球環境問題への対処(日本側:佐々木・竹島、米国側:J. Goodrich)

(12) 民営化に関する課題(日本側:山崎、米国側:P. Cook)

(13) 下水処理水の再利用(日本側:鈴木・吉岡、米国側:S. Hayashi)

視察

第4日 10月24日(木)

東京都三郷浄水場

東京都有明処理場

5. 会議の概要

10月21日

5. 1 開会

日本側の水道関係者を代表して高原亮治厚生労働省健康局長から、クリプトスポリジウムや内分泌かく乱化学物質など水道の水質管理に関して新しい問題が提起され、我が国では水質基準の見直し等に着手したところである、流域管理のあり方に関する検討も課題となっている、米国側代表団を歓迎するとともに、本会議において有意義な成果が得られることを期待している旨の挨拶があった。

続いて、日本側の下水道関係者を代表して曾小川久貴国土交通省都市・地域整備局下水道部長から、クリプトスポリジウムや内分泌かく乱化学物質などは下水道分野においても重要な問題として取り組んでいるところで、流域管理、生態系の保全も課題となっていることから、本会議において有意義な成果がもたらされることを期待している旨の挨拶があった。

次に、米国側を代表してUSEPA 国立リスク管理研究所水道・水資源部の Sally C. Gutierrez 部長から、長年本会議に出席していた Dr. Robert A. Clark 同前部長が本年度で定年退官となったことに触れた上で、本会議の主催にあたった日本側に謝意を示すとともに本会議での有意義な討論を期待している旨の挨拶があった。また、これと併せて、USEPA では課題を精選してより効果的な研究開発を実施することが必要とされており、特に企業に対して負担を強いるような規制を行う場合には、疾病の減少率などその効果を明確に示すことが強く求められていることなどが紹介された。

5. 2 上下水道事業の概要

1) 日本側発表

厚生労働省健康局谷津水道課長より、日本の水道行政システムの概要と最近における水道法改正の動向などについて紹介があり、経済、管理、技術等の面において問題を抱える小規模水道が多いため、第三者への業務委託や近隣事業者による統合などによる管理体制の強化を推進していることなどが述べられた。

国土交通省下水道部藤木流域管理官より、日本における下水道事業の概要について以下の通り説明がなされた。

平成 13 (2001) 年度末現在の下水道普及率は 63.5% であり、下水道の整備は着実に進展しているが、人口の少ない市町村では大都市と比較して下水道の整備が遅れており、これらの地域における下水道の早期整備が今後の課題となっている。また、日本の下水道は、下水道の整備状況が諸外国と比較して十分な状況とは言えず、下水道の早期整備に向けて、国と地方公共団体、日本下水道事業団の役割が今後益々重要となってくる。

日本では、人口密度が高い地域では下水道、農村地域では農業集落排水施設、その他人口密度が特に低い地域では浄化槽により下水が処理されており、各都道府県が汚水処理に関するマスタープラン（都道府県構想）を策定し、汚水処理施設が整備されている。

その他、直轄流総における汚濁負荷の県間配分について大阪湾を例に説明がなされるとともに、浸水対策や富栄養化対策や水道水源保全等の観点から、下水道の役割は重要なものとなっていること、現在は特に合流式下水道の改善対策が重要なテーマとなっていること等の説明がなされた。

2) 米国側発表

USEPA 国立リスク管理研究所の Sally C. Gutierrez 部長より、USEPA における現在の研究課題の概要について、以下の通り説明がなされた。

USEPA は 10 の地方事務所と 9 の部局で構成され、水道・水資源局では、飲料水中の有害物質の処理・管理に関する情報を提供し、流域管理に関する研究を先導する役割を担っている。

過去 10 年間の飲料水に関連する重要な研究課題は、クリプトスポリジウム及びジアルジアの管

理、砒素の問題、消毒副生成物の管理であり、今後の重要な研究課題は、有害物質のスクリーニング、流域全体でのアプローチ、効率的な基盤整備、モニタリングに関するものである。

その他、病原性微生物の調査に関連して、遺伝子工学に関する話題提供がなされたほか、水の安全性に関する話題、水質に関する重要な研究として、流域単位でのアプローチ(watershed approach)、日最大許容負荷量制度(TMDL)、有機性廃棄物の管理等が提示された。このうち流域単位でのアプローチについては、フーバーダムでのアトラジンの管理を例に説明がなされるとともに、汚濁負荷、有機性廃棄物の問題に関連する調査課題の説明がなされた。

最後に、米国では飲料水と水質の問題の検討を行っていること、水に関する現在の問題は以前に比べ解決困難になってきていること、水の安全性はますます重要になってきていること等の指摘がなされた。

3) 議論

水質の問題を解決するためには、農地からの汚濁負荷対策が必要不可欠であるとの観点から、米国における農業サイドとの連携手法について質問がなされ、まずは農業サイドと水質担当部局とのパートナーシップの構築が重要である旨説明がなされた。その他、水の安全性、日最大許容負荷量制度(TMDL)、砒素除去法等について若干の議論がなされた。

5. 3 水道水質規制の現状と動向

1) 日本側発表

厚生労働省健康局水道課・岸部水道水質管理官より、日本の水道水質管理制度の現状を紹介すると共に、水質管理の要となる水道水質基準の見直し等の今後の水道水質管理の方向性が展望された。すなわち、平成4年以降の水質基準の前面見直し等の準備中であって、消毒副生成物、クリプトスポリジウム等による病原微生物汚染、内分泌かく乱化学物質などの微量化学物質等の問題を背景として、厚生科学審議会生活環境水道部会水質管理専門委員会において、微生物、消毒副生成物、農薬、鉛等に関する基準とサンプリング方法の見直しにつき具体的な検討中であることなどが紹介された。

2) 米国側発表

USEPAのMcLain氏より、米国では、水道の水質規制に際して、利用者に対する情報提供と、パブリックコメントなどによる企業及び利用者への規制根拠の提示が求められていることが、まず初めに述べられた。続いて、基準策定は、最大許容濃度目標値(Maximum Contaminant Level Goal、MCLG)の設定→最大許容濃度(Maximum Contaminant Level、MCL)の設定→便益を考慮したMCLの修正の手順で進めていること、並びに、基準策定の際には、科学的妥当性(Sound Science)、健康影響、検出状況、処理技術の適用可能性(affordability)、費用-便益分析、基準の受容可能性(acceptability)に関する検討が必須であることが示され、特に小規模水道に関しては最善の処理技術(Best Available Technology, BAT)の策定が重要であることが指摘された。このほか、砒素に関しては、2006年までにBATの見直しを行う必要があり、昨年から全ての技術についてレビューを行っていることが紹介された。

3) 議論

米国側から、日本の水道において塩類や溶解性蒸発残留物に関しての基準や対策はどうなっているかとの質問があった。これに対して日本側から、水道原水への排水の混入や海水の侵入を考慮して塩素イオンにつき200mg/l以下の基準があること、さらに、沖縄や離島においては海水淡水化が行われており、このような場合にもこの基準が活用されていることが回答として述べられた。

5. 4 水道水源の水質管理/雨水流出

1) 日本側発表

北海道大学の眞柄教授より、水道原水及び浄水中のダイオキシン濃度に関して、ダイオキシンの各種異性体のうち大部分の濃度は浄水処理によって濁度などとともに減少するので、水道水では問題となるような濃度ではないが、浄水過程における塩素処理によって原水中のクロロフェノールからジベンゾフランが生成されるため、4 塩素化ダイオキシンの濃度が増加することや、原水中におけるダイオキシンの形態別濃度の主成分分析結果から、過去に農薬として使われたクロルニトロフェン（CNP）とペンタクロロフェノール（PCP）に不純物として含まれるダイオキシンが環境中に残存していて、これらは今でも水系の水質に影響を与えていることが認められることが報告された。

国土交通省国土技術政策総合研究所下水道研究室の森田室長より、日本における合流式下水道雨天時越流水（CSO）対策の実態と平成 14 年に提案された新しい対策方針が紹介された。まず、下水道整備を行っている 2219 都市中、合流式下水道がある都市は東京、大阪、名古屋など主要都市を含む 192 都市であり、そのうち 7 割の都市が合流改善計画を策定していないという実態が紹介された。日本で合流式下水道が選択された理由については、山がちな日本では、低平地に人口が集中し、洪水対策が必須であり、さらに、人口過密な都市内の狭い街路に下水管渠を入れる必要があったためであると説明された。新しい対策方針については、東京お台場公園に漂着したオイルボールを契機に、国土交通省、環境省、海上保安庁、学識経験者、地方自治体などを構成メンバーに委員会が設置され、このなかで合流式下水道対策全般の議論がなされ、平成 14 年 3 月に報告が出されたことが紹介された。さらに、3 つの短期的な目標、すなわち分流並み、保健衛生の確保、景観保護についてその内容の説明があった。

2) 米国側発表

米国水環境研究財団（WERF）の Richards 氏より、米国における流域管理、雨水管理、水道水源管理政策の現状が報告された。流域管理については、水浄化法で全ての水域で水浴・釣り可能な水質にするという目標を達するため、ノンポイントソース対策の必要性が指摘され、日最大許容負荷量制度（TMDL）に関する課題が示された。雨水管理については、雨の量と質の両面対策の必要性が指摘された。水道水源管理については、クリプトスポリジウム等病原性微生物や化学物質排出源対策等が示された。

3) 議論

米国の流域管理政策に対して、水環境健康リスク評価方法、河川における窒素リンの水質基準の設定方法、病原性微生物の挙動予測方法について議論がなされた。また、日米の CSO 対策の目標について議論が行われた。米国側から、合流式下水道で処理されている下水流量や、対策推進のための政策的支援措置について質問がなされた。また、水道側参加者から合流式下水道雨天時越流水対策の重点化について、水道水源での重点化の必要性について意見が出され、例として淀川の事例（京都・大阪）が提示された。CSO 対策については、日米の上下水道双方の関心が高いことが伺えた。

5. 5 上下水道技術の課題

1) 日本側発表

国立保健医療科学院水道工学部の国包部長より、水道分野において、今年度から健全な水循環に関する研究が実施されていること、WHO が飲料水水質ガイドラインの中で重要視している水安全計画（Water Safety Plan）の策定が今後重要な検討課題となると考えられること、水道関連調査研究検討会が発足して水道分野における調査研究の進め方に関して広く検討が行われていることなどが紹介された。さらに、その他の研究課題としては、テロ行為などに対する危機管理対策や原水汚染事故対策、クリプトスポリジウム対策、内分泌かく乱化学物質に関する情報収集、親水性かつ難分解性化学物質の汚染対策、給水装置の適正管理等が重要な研究課題であることが述べられた。

国土技術政策総合研究所の高橋下水道研究官より、下水道分野の研究目標として、水環境の創出、安全な都市生活、省エネルギー、下水道事業の効率化、アカウントビリティからなる下水道新技術

5ヶ年計画（1999～2003）が紹介された。また、技術開発は、大都市、国総研、独法土研、日本下水道事業団、下水道新技術推進機構が連携して実施しており、現在民間も巻き込んで進行中の研究プロジェクトとしてSPIRIT21が紹介された。具体的な技術開発の例として、窒素除去に関して、大都市の処理場のアップグレード、膜、固定化担体を用いた省スペース技術の開発、汚泥からの資源回収技術、生態系に優しい下水道への取り組みなどが紹介された。

2) 米国側発表

米国水道協会研究財団（AWWARF）の Manwaring 専務理事より、AWWARF における研究トレンドが紹介された。例えば、住民参加を踏まえた施設の維持管理、環境規制の強化への対応、民活の導入による水道事業の再構築、人口増加による水需要増大への対応、クロストレーニングの導入等による労働生産性の向上、情報化・自動化技術の導入による効率化、流域管理の必要性等が紹介された。

3) 議論

米国側から、日本では鉛の基準を厳しくするのに長い期間を要したのはなぜかとの質問があった。これに対して日本側から、10年前の見直しの際に暴露量調査、血中濃度調査等を行ったところ、成人及び子供の血中鉛濃度は低く基準強化の緊急性が認められなかったが、国際的な動向や電池・電気関係での鉛使用量削減の動向を考慮し、10年後には基準を厳しくすることとしたこと、今日では厳しい基準の遵守が可能であると行政が判断したことなどの回答があった。

日本側から、危機管理の観点から常時監視装置の話があったが、どのような内容の研究かとの質問があった。これに対して米国側から、今月から軍や疾病管理予防センター（Centers for Disease Control and Prevention, CDC）と協力して研究を開始したところであり、市場で入手可能な監視装置について調査を実施する予定であるが、その詳細はまだ公表できないとの回答があった。

このほか、日本側参加者から、日本では米国における健康勧告集（Health Advisory, HA）のようなデータの取りまとめを行わないのはなぜかとの質問があり、これに対して日本側行政担当者から、専門委員会など公式の場を通して意見が上げれば考慮したいとの回答があった。

米国側より、流域管理について、ノンポイントソースの削減方法が重要な課題であると指摘された。また、米国における上・下水道間の協力体制については、USEPA と米国水道協会（AWWA）、米国水環境連盟（WEF）、NPO 間で連携していることが紹介された。

10月22日

5. 6 水道水質検査における分析精度管理

1) 日本側発表

国立医薬品食品衛生研究所環境衛生化学部の安藤部長より、日本の水道における水質検査体制の現状と問題点、水質検査における分析精度管理の必要性、今後の検討課題等について紹介があった。

2) 議論

米国側から、水質検査機関に同一試料を一斉送付してデータを収集するいわゆる外部精度管理を行っているかとの質問があった。これに対して日本側から、大規模水道事業体の水質検査機関については今年度から外部精度管理を始めたが、民間の水質検査機関については以前から行っているとの回答があった。

5. 7 砒素対策

1) 米国側発表

米国テキサス州 El Paso 市水道公社の E. G. Archuleta 氏より、水道原水砒素汚染問題に対する取り組みにつき報告があった。El Paso は人口 70 万人の都市で、年降水量は 8 インチ（約 20mm）し

かないため、再生水を用いて地下水涵養してから再びこれを取水して水道原水としていること、砒素の MCL を $10\mu\text{g}/\text{l}$ とする砒素規則が 2002 年 2 月 22 日より施行され、基準では年 4 回測定値の平均値がこの値を超えてはいけない（また、一時的にでも $40\mu\text{g}/\text{l}$ を超えてはいけない）としていること、El Paso 水道で原水として用いている地下水の中には基準値を超過するものがあることなどの事情から、水酸化第二鉄粒子を用いたカラム吸着法や、塩化第二鉄による凝集と精密ろ過との組み合わせによる方法につき検討し、総合的な評価結果に基づき前者の方法を採用していることが述べられた。

2) 議論

日本側から、札幌市の水道の集水域では砒素約 $4.5\text{mg}/\text{l}$ を含む温泉水が湧出しており、そのため原水中の砒素濃度が $22\sim 35\mu\text{g}/\text{l}$ であるが、前塩素、凝集、沈澱及びろ過により処理水中の砒素濃度 $4\sim 5\mu\text{g}/\text{l}$ を達成していることが紹介された。

続いて、砒素濃度の基準値につき日米間で意見交換があり、発がんリスクレベル 10^{-5} に相当する濃度 $2.5\mu\text{g}/\text{l}$ になると浄水処理での対応が困難であること、米国では $20\mu\text{g}/\text{l}$ でも良いという考え方もあるが、USEPA では $10\mu\text{g}/\text{l}$ 以下を支持していること、米国では砒素が毒物であるという認識が高いので、科学的な裏付けがあったとしても甘い基準値では受け入れられないことなどが指摘された。

5. 8 水質管理と微生物

1) 日本側発表

国立感染症研究所寄生動物部の遠藤部長より、水道における微生物学的観点からの水質管理に関しては、危害度分析重要管理点方式 (Hazard Analysis and Critical Control Point, HACCP) の概念の導入が必要であり、消毒が有効な赤痢菌などの細菌、消毒が有効な A 型肝炎ウイルスなどのウイルス、消毒が有効でないクリプトスポリジウムなどの原虫、配水システムで繁殖するレジオネラなどの細菌の 4 タイプに分けて、それぞれに見合った管理を行うことが重要であるとの見解が示された。これを踏まえて、クリプトスポリジウムに関しては、その排出量が多い幼少動物を集水域から遠ざけるのが原水汚染を防ぐ有効な方法であると考えられること、子供、免疫力を失った人、高齢者等が影響を受けやすいこと、家畜の症状、学童の欠席率等の情報を活用して集団感染の発生を察知するシステムの構築が重要であること、水源管理が重要であり、その費用－便益効果は高いと考えられること、健康リスク評価や監視などにおいて多方面の連携が必要であることなどが述べられた。

国総研の山下主任研究官より下水処理研究室で調査を進めている、下水処理水の放流、及び再利用におけるクリプトスポリジウムの病原リスク対策について説明がなされた。

現在はクリプトスポリジウムの存在量把握のために全国数カ所の下水処理場で、月に一度、流入水と処理水中のクリプトスポリジウム数を調査している。このデータにモンテカルロ法を適用してクリプトスポリジウムの年間感染リスクの定量的評価を実施するとともに、リスクレベルが目標値を超過しないように管理するためのリスク管理手法の策定に向けて、想定されるリスク発生への対策の枠組みを検討している。

2) 米国側発表

フィラデルフィア市水道局の Jung Choi 氏より、病原性微生物汚染の抑制を含めた水道水質の向上の例として、処理施設の改善のみならず、給水システムの改善、住民との対話、行政上の仕組みの改善等、総合的な改革を行ったフィラデルフィアの例を紹介した。

フィラデルフィアの給水システムは 19 世紀末から 20 世紀初頭にかけて作られ、1970～1980 年代に一部修理されたが、全般的には老朽化していた。また、1990 年代には水道水質に新たな規制が設けられた。このため、1995 年にアメリカ国内外の専門家とフィラデルフィアの職員が一体となって

老朽化した給水システムのチェックを行ったところ、病原性微生物に対して非常に脆弱なシステムであることがわかった。これを受けて、給水システムの改修・改善に対して5年間にわたり州の予算が支出されることとなった。また、1993年には調査計画が生まれ、水道水中のクリプトスポリジウムやジアルジアのモニタリングを行うこととなった。これらの対策の結果、濁度が大きく改善され、消毒時に重要な指標となる接触濃度と時間の積であるCT値も十分に確保できるようになった。また、1998年にはパイロットプラントを設け、数々の指標について最適値を明らかにした。

給水システムにも注意を払い、新しい管にはキャップを取り付け、新規運用時には消毒を義務付けた。また、クロスコネクション防止装置の設置を義務付け、設置していない建物には給水を止める措置をとった。

さらに、水質委員会を設け住民との対話を図ったり、水質事故が生じた場合には行政的な対応をサポートしたりするシステムを設けた。

3) 議論

日本側のクリプトスポリジウムの調査方法について質問があり、測定法の回収率等について説明があった。また、リスク評価において、病人や老人のように免疫力の低下している人がクリプトスポリジウムへ感染しやすいとみなして考慮しているか、との質問に対し、現在のところ感染率に関するデータがないため考慮しておらず、全体としてのリスクを算出していると説明があった。また、ミルウォーキーや埼玉での発症事例における免疫力と感染率の関係について議論がされた。アメリカ側にはクロスコネクションについて質問があった。日本では特に水道水に関してはクロスコネクションはあり得ないが、なぜフィラデルフィアではクロスコネクションがあり得たのか、という質問には、昔のことなので詳細はわからないが、現在では対策のおかげでなくなったと説明があった。また、水質委員会の役割についても議論がされた。

5. 9 内分泌攪乱化学物質

1) 日本側発表

国立保健医療科学院水道工学部の国包部長より、水道分野における内分泌かく乱化学物質(EDCs)に関する研究では、水道原水の全国的な汚染状況調査を行っているほか、水道原水などにおいてよく検出されるフタル酸ジ-2-エチルヘキシル、フタル酸ジ-n-ブチル、ビスフェノール A 及びノニルフェノールの浄水処理における除去特性、並びに、水道用資機材からの溶出特性の検討を行っており、特に問題とすべき結果は得られていないが、水道管からの溶出試験では通水初期などにこれらの溶出が認められることが報告された。

独立行政法人土木研究所水質チームの田中上席研究員から、国土交通省が実施した下水処理場におけるEDCsの実態調査結果についての発表が行われた。対象化学物質の選定の考え方、個々の化学物質を対象とした下水中のEDCsの機器分析法およびELISA法による実態調査結果、下水及び処理水の組み換え酵母を用いたエストロゲン様活性の測定結果とその要因および、魚類を用いた下水処理水のエストロゲン様活性の評価(内分泌攪乱作用により雄コイの血液中に生成される卵黄タンパクの前駆体のビテロジェニンをエンドポイント)の調査結果について発表が行われた。

2) 米国側発表

USEPA リスク管理研究所のKathleen Schenck 女史より「内分泌攪乱化学物質の除去のための浄水処理技術の評価」と題された発表が行われた。まず、米国の水環境におけるEDCsの実態調査結果が示され、調査対象物質として、天然と合成の女性ホルモンである 17β -Estradiol、Estrinol、Ethinylestradiol、Progesterone、および天然の男性ホルモンであるTestosterone、Dihydrotestosteroneの6物質が選定された経緯が説明された。技術的なアプローチとして、1) 固相抽出とLC/MSによる対象物質の定量 2) エストロゲン様活性のレポータージーンアッセイおよびMVLNアッセイによる評価 3) 各種の浄水技術のベンチスケールおよびパイロットスケールでの浄

水削減効果の評価 4) 活性炭処理に関する等温吸着平衡試験の結果が示された。

3) 議論

日本側、米国側からの EDCs に関する発表に関して、活発な議論が展開された。主な論点は以下のとおりである。①数多くの内分泌かく乱作用が疑われる化学物質の中から、調査対象物質を抽出、選定した経緯、およびその考え方について議論がなされた。②魚類の雌性化について、ビテロジェニンの生成、生殖器官の異常、個体数の変化など様々なエンドポイントが考えられる。何をもって評価すべきかについての議論がなされた。③日本および米国で実施された EDCs の実態調査結果の相違について比較すると、調査機関、調査地点や調査手法の選定方法などの数多くの要因により、相違が生じていることが推察される旨の議論がなされた。④魚類の生殖を考える際には、EDCs 以外の他の要因（ハビタット、外来種など）についても包括的に評価する必要があることが議論された。

10月23日

5. 10 水道における危機管理及び震災対策

1) 日本側発表

東京都水道局総務部の牧田副参事より、日本の水道における浄水場の危機管理対策について、東京都水道局の実例紹介があり、全浄水場に魚類監視装置を設置して原水を常時監視していること、テレビカメラやトラップタイプのセンサーを要所に設置するとともに、万一の場合には警備会社や警察にも直ちに連絡できるようにして不法侵入防止を図っていること、安全性向上のほか、藻類の発生防止などを考慮して、ろ過池へのドーム型カバーの設置を検討していることなどが報告された。また、地震による施設の損傷に備えて、原水連絡管を浄水場間に布設していることや、管路施設の計画的な維持管理と更新を行う中で耐震化を図っていることなども併せて述べられた。

2) 米国側発表

USEPA の S. W. Clark 氏より、水道に対するテロ行為の可能性は低いですが、万一そのようなことがあった場合には大きな影響がもたらされるため、米国では 1991 年の湾岸戦争時に危機管理対策についての大統領令 (Presidential Decision Directive --- 63) が出され、その当時から、公共事業や産業界との協調、政府関係機関の横の連携、脅威の特性分析と対策手法の開発、情報センターの設立等が課題であったが、2001 年 9 月 11 日の同時多発テロ事件後は USEPA の役割が増し、新組織が設置されたことなどが紹介された。また、水道への脅威としては、核、生物及び化学兵器 (NBC)、物理的被害、コンピュータシステム (SCADA など) への攻撃等の可能性があることから、脆弱性の評価手法に関する検討、危機管理に関するガイダンスの作成、河川や管網の流量モデルの構築、分析方法の検討、処理技術に関する検討等を行っていることが述べられた。

3) 議論

米国側から、日本の水道の危機管理対策の財源はどうなっているかとの質問があった。これに対して日本側から、危機管理のためのガイドラインをすでに整備していること、ろ過池の覆蓋設置に対して補助金を支出していること、バイオアッセイの積極的な導入やパトロールの強化を図っていることなどが回答として述べられた。これに関連して、バイオアッセイのことを除いては、日米両国とも、テロ対策を目的とした水質監視に関するガイドラインと言えるようなものは、特に作成していないことが確認された。

また、米国では USEPA がすべての水道に対して脆弱性に関するレポートの提出を求めていることが、特に話題として取り上げられ、米国側から、非常にセンシティブな問題なのでこのような情報を収集することに米国内でも議論があることが述べられた。これに関連して、日本側から、米国における脆弱性評価につき日本も参考としたいが、関連情報を提供してもらえるかとの質問があり、

これに対して米国側から、要請があれば検討したいとの回答があった。

5. 1.1 新しい水処理技術

1) 日本側発表

水道技術研究センター浄水技術部の林部長より、日本の水道分野における研究プロジェクトとして1997～2001年度に実施した高効率浄水技術開発研究(ACT21)の概要につき紹介があり、それに先立つ1991年度からの膜分離型新浄水技術開発研究(MAC21)などを含めた3つの大型研究プロジェクトを通じて、凝集の高効率化、新凝集剤の有効性の評価、高速ろ過、膜ろ過等の新技術の開発と導入に大きな成果を上げてきたことが述べられた。

日本下水道事業団の渡部技術開発部長より、日本の下水処理場の整備状況の説明があり、また、新技術として膜分離活性汚泥法及びステップ流入式循環硝化脱窒法についての紹介が行われた。

2) 米国側発表

バージニアポリテクニク州立大学のJohn Thomas Novak教授より施設の小型化、排水規制の強化への対応、処理水再利用等を目的とした処理技術としての膜処理技術の紹介、及び生物毒性評価技術の紹介が行われた。

3) 議論

膜分離活性汚泥法でのリン除去の可能性、遺伝子組み換え微生物の利用に関する法的規制、生物毒性評価技術の現場への適用法等に関する議論がなされた。

5. 1.2 地球環境問題への対処

1) 日本側発表

阪神水道企業団配水課の佐々木課長より、地球環境問題に関する取り組みにつき紹介があり、長期的な観点から見て気温はあまり変わっていないが、原水を取水している淀川の水温が上昇して今日では気温とほぼ同じになっていること、地球環境保全の観点から、省エネルギー、二酸化炭素発生量の低減、汚泥再利用等に積極的に取り組んでいることなどが示され、さらに、東京都、大阪府、神戸市等の水道においても環境負荷低減や省エネルギーのための新しい試みが行われていることも述べられた。

東京都下水道局業務部の竹島排水指導課長より、下水処理場からの温室効果ガス排出削減のための対策に関する調査結果の報告があり、焼却炉の燃焼温度を上昇させることによる N_2O 削減を図る手法における、補助燃料の使用量増加による CO_2 排出増を含めたトータルの温室効果ガス排出量の削減効果についての検討結果の説明が行われた。

2) 米国側発表

USEPAリスク管理研究所のJames Goodrich水質管理課長より、地球温暖化による気候変動に伴う集中豪雨の増加等が、下水処理に与える影響及びその対策に関する検討結果についての報告が行われた。

3) 議論

米国側から、水温の上昇は一般の河川でも観測されているかとの質問があり、これに対して日本側から、気温との詳細な比較は淀川についてしか行っていないが、一般に河川の水温が上昇傾向にあることは確かであるとの回答があった。

日本側から、米国の水道施設や下水道施設では、省エネルギーや温室効果ガスの発生量削減などにどのように取り組んでいるかとの質問があった。これに対して米国側から、連邦政府としては省エネルギーを推奨しており、また個々の施設ではISO規格の認証取得などに取り組んでいるとの回答があった。

5. 1 3 民営化問題

1) 日本側発表

日本水道協会の山崎特別会員より、日本では平成13年に水道法が改正され、水道事業の第三者業務委託が正式に認められるようになったことにより、民間事業者の水道事業への参入の可能性が広がったこと、現在日本では水道事業の請負会社として約10社があること、日本では水道事業の民営化に関して賛否両論があることなどが紹介された。

2) 米国側発表

全米水道業界協会 (National Association of Water Companies, NAWC) の P. Cook 氏より、米国における水道民営化の現状と動向について紹介があり、今後水質などに関する規制がますます厳しくなり、また一方ではより効率的な水道事業運営が求められ、施設更新の必要性も高まる中で、財政的な事情などから民営化の動きがさらに加速されるであろうとの見解が述べられるとともに、民営化に際して特に問題となる点や考慮すべき事項につき示された。

3) 議論

日本側から、日本における民営化の可能性について質問があったのに対し、米国側から、歴史的背景や社会的習慣の違いから日米の状況には差異があるが、民営化の長所、短所については共通の点が多く、それぞれの文化にあった方法がとられることが望ましいとの回答があった。また、日本側から、公衆の安全確保の観点から水道民営化に問題はないかとの質問がなされたが、これに対して米国側から、水道の供給と顧客に対するサービスが重要であることにかわりはなく、これまで特段の問題はないが、契約が重要である点の説明がなされた。米国側から、民営化には、サービス向上などの利点があるが、財政面や安全性の確保の面で、第三者による監視の必要性があるとの指摘がなされた。

5. 1 4 下水処理水の再利用

1) 日本側発表

独立行政法人土木研究所リサイクルチームの鈴木上席研究員から日本での下水処理水の再利用の概要と、平成13年7月に策定された「ウイルスの安全性からみた下水処理水の再生処理法検討マニュアル(案)」(以下、マニュアル案)の内容が紹介された。下水再利用において問題となる再生水の微生物学的安全性について検討するため、日本国内の下水処理場10ヶ所を対象に2年間にわたって二次処理水中の腸管系ウイルス濃度を調査するとともに、塩素、オゾン、紫外線の各消毒法および砂ろ過による腸管系ウイルス除去性能を実験により評価した。この結果に基づき、いくつかの曝露シナリオに沿って健康リスク評価を行い、必要な再生水の処理レベルを明らかにしたことが報告された。

また、札幌市下水道局の吉岡技術開発担当課長より、札幌市における下水処理水再利用の修景用水利用、融雪・流雪溝用水利用等の事例紹介がされた。砂ろ過と塩素処理による腸管系ウイルスの除去性能に基づき、この修景用水の微生物学的年間感染リスクの定量的な評価を試みていることが紹介された。

2) 米国側発表

ユニオン市衛生組合の Stephen T. Hayashi 氏より米国の水環境研究財団 (WERF) における排水再利用に関する研究の現状につき紹介があり、膜-バイオリアクターや高度膜分離による処理技術、PCR/リアルタイム-PCR、マイクロアレイ、分子ビーコン等を用いた微生物の監視技術とリスクアセスメント、内分泌かく乱化学物質や医薬品などの化学物質の検出技術とオンライン毒性監視技術、

再生水の安全性に関するリスクコミュニケーション手法等の研究に取り組んでいるとの報告があった。

3) 議論

米国側から、マニュアル案の策定に関連し、下水処理水再利用によるウイルス感染の発生事例について質問があった。これに対して、日本では下水処理水再利用によるウイルス感染事例は報告されていないが、水中のウイルスが貝類に蓄積し、貝類を経由して発症するとの報告もあるため、下水道においてもウイルスは問題として認識していると回答があった。

日本側から、啓蒙活動 (Public Outreach) に関する具体的な研究内容についての質問があった。これに対して、情報への到達機会の拡大手法、費用対効果、技術的問題の歴史、リスクの説明手法等、自然科学的な研究ではなく社会科学的なものであり、ケーススタディーも行っているとの回答があった。

また、日本側から、飲料水としての下水処理水再利用に関する質問があった。これに対して、経済的・社会的な検討が必要であるとの回答があった。地下水涵養した後、飲用取水料水としている事例があり、今後直接再利用も行われるであろうが、長期間にわたる啓蒙教育が必要であるとの考えが示された。

6. 総括

13 課題、32 編の発表が終了した後に、本会議の総括が行われ、会議要録 (案) の内容に関して日米両国間で基本的な合意が得られた。なお、細部の表現については、各参加者からの意見を得て後日修正の上、改めて送付されることになった。このようにして作成された会議要録 (英文) を別添 3 に示す。日米両国間の合意事項は次の通りである。

- 両国が現在、特に化学・微生物の分野で、水環境における複雑な問題に直面しており、残された課題の解決は以前よりも困難になっている。
- 人間や生態系のリスクを管理するために、流域管理、水処理・供給、施設の更新を含む総合的なアプローチが必要である。
- 計画段階では、最新の科学的知見に基づき優先順位をつけるのは不可欠である。そして、実施段階では、費用便益を考慮しつつリスク管理に関する適切な情報を提供し利害関係者とのコミュニケーションにより、科学的な意志決定を行うことがより重要になる。
- 研究組織、上下水道事業者、政策立案者による協力が重要である。
- 日米間の情報交換は経験や知見を共有するうえで非常に有益である。

さらに、本会議が両者間の自由な意見・情報交換の場となり、両国の水道水質管理と下水処理技術に大いに貢献していることで意見の一致を見た。また、次の会議が、2004 年に持ち回りにより米国で行われ、それまでの間にいくつかの特定の領域の会合が行われることについて両者は同意した。

最後に、次回の会議に向けてのコンタクトパーソンとして、米国側は K. Schenck 女史 (USEPA 国立リスク管理研究所)、日本側は国包章一国立保健医療科学院水道工学部長及び宮原茂国土交通省国土技術政策総合研究所下水道研究部長を指名すること、および以下の特定の領域を今後の議論テーマとすることに合意した。

- 流域管理、水道水源管理、雨水管理
- 病原性微生物の観点からの水質保全
- 内分泌攪乱化学物質
- 水の安全
- 施設の更新
- 地球環境対策

- 上下水道における最適管理 (Best Management Practice)

7. 視察の概要

10月24日に、USEPA リスク管理研究所 James Goodrich 水質管理課長を初めとする米国代表団一行（なお、Sally Gutierrez 団長は、前日に所用のため帰国した。）は、東京都水道局三郷浄水場と同下水道局有明処理場を訪問した。

最初に代表団一行は、三郷浄水場を訪問した。三郷浄水場は日量 110 万 m³ の施設能力を有し、江戸川から取水した原水を浄水処理して主に新宿、中野、渋谷区等の都民約 180 万人に給水している。特に、取水源である江戸川上流の家庭排水等によるカビ臭、アンモニア性窒素等を高度に除去するため、通常の浄水処理である凝集沈殿・ろ過工程の間に、オゾンと生物活性炭を組み合わせた高度浄水処理施設（日量 55 万 m³）を平成 11（1999）年から稼働させている。また、消毒剤として、液体塩素の使用を止め、安全で維持管理が容易な次亜塩素酸ナトリウムを塩水の電気分解により生成し使用している。代表団は、概要の説明の後、中央監視施設やオゾン・生物活性炭を用いた高度浄水処理施設などを見学した。米国側は、水道水源である江戸川の水質、テロ対策、高度浄水処理のコストなどについて関心を示していた。

代表団は、三郷浄水場で昼食の後、午後は有明処理場を訪問した。移動中のバス車中で、東京都下水道局技術開発課の鈴木建主査により、東京の下水道の概要についてビデオによる説明が行われた。有明処理場は、臨海副都心内の下水の処理を行うため平成 7（1995）年に稼働開始し、日量 3 万 m³ の高度処理能力を有している。処理方式は、嫌気・無酸素・好気処理と生物膜ろ過処理と取り入れており、高度処理水は中水道として臨海副都心に供給し、トイレ洗浄用水などに再利用されている。また、処理施設は都市景観を損なわないように地下化されており、上部空間はテニスコート、プール、公園等に利用されている。なお、発生した汚泥は、全量砂町水処理センターへ圧送されている。有明処理場では、竹島正東京都下水道局排水指導課長らによる説明が行われ、嫌気・無酸素・好気法、生物膜ろ過、オゾン、高速ろ過等の高度処理施設のほか、中央管制施設、上部利用施設（有明テニスの森、プール、公園等）などを見学した。米国側は、下水処理水再利用のための処理技術、コスト、再生水の安全性などについて関心を示していた。

8. おわりに

今回の会議は、日米双方の 32 編の発表を 3 日間で行うというハードスケジュールにもかかわらず、最後まで熱心な議論が行われ、日米双方、水道、下水道双方の情報交換という点では極めて有意義なものであった。討議時間を十分に確保するために、通訳を設けなかったが、発表者と質問者の議論は、休憩時間や昼食時間、レセプションでも活発に行われた。これは、日米の上下水道が直面している課題が共通であり深刻であることの証左と考えている。

今回の会議は、2004 年に米国で開催される予定であり、その際には、今回の会議で得られた貴重な情報を有効に活用し、下水道が解決しなければならない諸課題に対する解決策を持ち寄り、報告できることを期待したい。

最後に、本会議の開催にあたりご協力いただいた日米両国の関係各位に厚く御礼申し上げたい。

平成 14 年 10 月 15 日

(問合せ先)

厚生労働省 健康局水道課水道水質管理室

室長補佐 松田 和久 (03-5253-1111, 内線 4032)

国土交通省 都市・地域整備局下水道部下水道企画課

課長補佐 松原 誠 (03-5253-8111, 内線 34162)

日米水道水質管理及び下水道技術に関する専門家会議の開催について

Japan-US Governmental Conference on
Drinking Water Quality Management and Wastewater Control

厚生労働省と国土交通省は、平成 14 年 10 月 21 日から 24 日にかけて三田共用会議所において「第 2 回日米水道水質管理及び下水道技術に関する専門家会議」を開催することとしましたのでお知らせします。

1. 経 緯

日米両国間の水道及び下水道分野の技術交流については、これまで分野ごとで実施されてきたが、共同開催により情報及び意見交換を行うことが有益であるため、平成 11 年に「第 1 回日米水道水質管理及び下水道技術に関する専門家会議」として統合した会議を米国コロラドスプリングスで開催したところである。

今回、第 1 回会議における合意に基づき、第 2 回会議を日本で開催するものである。

2. 開催日程等

平成 14 年 10 月 21 日 (月) ~ 23 日 (水) 会議 (東京、三田共用会議所)

なお、翌 24 日 (木) に東京周辺上下水道施設の視察を予定している。

3. 会議の内容

会議は「上下水道事業の概要」、「水道水源の水質管理/雨水流出」、「水質管理と微生物」などのテーマを中心として双方から発表を行い、情報交換、意見交換を行うこととしている。

4. 出席予定者

日本側 (水道分野) : 厚生労働省健康局長、水道課長、水道水質管理官、厚生労働省付属研究所部長、大学研究者、水道事業者研究者など 11 名

日本側 (下水道分野) : 国土交通省下水道部長、流域管理官、国土技術政策総合研究所下水道研究部下水道研究官、独立行政法人土木研究所研究者、下水道研究者など 10 名

米国側 : 米国環境保護庁 (EPA) 国立リスク管理研究所 S.C.ギティレッツ水道水資源部長、J.A.グッドリッチ水質管理課長をはじめ、米国水道協会研究財団及び水道事業者などからの研究員を含め、計 14 人が参加予定

5. その他

- ・カメラ撮りは会議冒頭挨拶のみ可能です。
- ・同日付けで厚生労働記者会、日比谷クラブ、労政記者クラブにおいても発表しております。

別添2 第2回日米水道水質管理及び下水道技術に関する政府間会議日程（英文）

**Agenda of
Japan - U.S. Governmental Conference on
Drinking Water Quality Management and Wastewater Control**

**October 21-24, 2002
Mita Kaigisho, Tokyo, Japan**

DAY 1	ITEM	SPEAKER
0930 - 0940	Welcome speech	Dr. Ryoji TAKAHARA, Director General, Health Service Bureau, MHLW, Japan Mr. Hisataka SOKAWA, Director General, Sewerage and Wastewater Management Department, MLIT, Japan
0940 - 0945	Opening remarks	Mrs. Sally C. Gutierrez, Director, Water Supply and Water Resources Division, NRMRL, US EPA
0945 - 1000	Overview of drinking water quality management and wastewater control	Dr. Ryutaro YATSU, Director, Water Supply Division, MHLW, Japan (drinking water)
1000 - 1015	Overview of drinking water quality management and wastewater control	Mr. Osamu FUJIKI, Director of Watershed Management, MLIT, Japan (wastewater)
1015 - 1045	Overview of drinking water quality management and wastewater control	Mrs. Sally C. Gutierrez, Director, Water Supply and Water Resources Division, NRMRL, US EPA
1045 - 1115	General discussion	Japan/US
1115 - 1130	Break	
1130 - 1150	Current and future regulatory issues in drinking water (alternative regulatory approaches)	Mr. Kazumi KISHIBE, Director, Office of Drinking Water Quality Management, MHLW, Japan
1150 - 1210	Current and future regulatory issues in drinking water (alternative regulatory approaches)	Jennifer McLain, US EPA
1210 - 1240	General discussion	Japan/ US
1240 - 1340	Lunch	
1340 - 1355	Issues in watershed protection/ source water protection/storm water flows	Prof. Yasumoto MAGARA, Hokkaido University, Japan (drinking water)
1355 - 1410	Issues in watershed protection/ source water protection/storm water flows	Dr. Hiroaki MORITA, Head, Wastewater System Division, NILIM, Japan (wastewater)
1410 - 1440	Issues in watershed protection/source water protection/storm water flows	Tyler Richards, WERF, US
1440 - 1510	General discussion	Japan/ US
1510 - 1525	Break	
1525 - 1540	Research agenda in drinking	Dr. Shoichi KUNIKANE, Director, Department

	water/wastewater control	of Water Supply Engineering, NIPH, Japan (drinking water)
1540 - 1555	Research agenda in drinking water/wastewater control	Dr. Masahiro TAKAHASHI, Research Coordinator for Water Quality Control, NILIM, Japan (wastewater)
1555 - 1625	Research agenda in drinking water/wastewater control	Mr. James Manwaring, AWWARF, US
1625 - 1655	General discussion	Japan/US
1730 -	Welcome reception hosted by Japan	

DAY 2	ITEM	SPEAKER
0930 - 1000	QA/QC for the monitoring of drinking water quality	Dr. Masanori ANDO, Director, Division of Environmental Chemistry, NIHS, Japan
1000 - 1015	General discussion	Japan/US
1015 - 1045	Arsenic	Mr. Ed Archuleta, GM, El Paso Waterworks, US
1045 - 1100	General discussion	Japan/US
1100 - 1115	Break	
1115 - 1130	Microbial water quality control	Dr. Takuro ENDO, Director, Department of Parasitology, NIID, Japan (drinking water)
1130 - 1145	Microbial water quality control	Mr. Hiromasa YAMASHITA, Senior Researcher, Wastewater and Sludge Management Division NILIM, Japan (wastewater)
1145 - 1215	Microbial water quality control	Jung Choi, Philadelphia Water Department, US
1215 - 1245	General discussion	Japan/US
1245 - 1345	Lunch	
1345 - 1400	Endocrine disrupting chemicals	Dr. Shoichi KUNIKANE, Director, Department of Water Supply Engineering, NIPH, Japan (drinking water)
1400 - 1415	Endocrine disrupting chemicals	Dr. Hiroaki TANAKA, Team Leader, Water Environment Research Group, PWRI, Japan (wastewater)
1415 - 1445	Endocrine disrupting chemicals	Ms. Kathleen Schenck, US EPA
1445 - 1515	General discussion	Japan/US
1515 - 1530	Break	
1530 - 1600	Water security issues/seismic design issues	Mr. Yoshito MAKITA, Director for Special Programs, General Affair Division, Bureau of Waterworks, TMG, Japan
1600 - 1630	Water security issues /seismic design issues	Dr. Steve Clark, US EPA

1630-1700	General discussion	Japan/US
1800 -	Return reception hosted by US	

DAY 3	ITEM	SPEAKER
0930 - 0945	New treatment trends (biotechnology/membranes)	Mr. Hideki HAYASHI, Director, Water Treatment Technology Division, JWRC
0945 - 1000	New treatment trends (biotechnology/membranes)	Dr. Haruki WATANABE, Director of Research and Technology Development Department, JSWA, Japan (wastewater)
1000 - 1030	New treatment trends (biotechnology/membranes)	Dr. John Novak, WERF, US
1030 - 1100	General discussion	Japan/US
1100 - 1115	Break	
1115 - 1130	Global and environmental considerations in drinking water supply and wastewater control (climate impact/energy savings)	Mr. Takashi SASAKI, Director, Distribution Division, Hanshin Water Supply Authority
1130 - 1145	Global and environmental considerations in drinking water supply and wastewater control (climate impact/energy savings)	Mr. Tadashi TAKESHIMA, Director of Industrial Wastewater Guidance Section, Bureau of Sewerage, TMG, Japan (wastewater)
1145 - 1215	Global and environmental considerations in drinking water supply and wastewater control (climate impact/energy savings)	Dr. James Goodrich, US EPA
1215 - 1245	General discussion	Japan/US
1245 - 1345	Lunch	
1345 - 1415	Privatization issues	Mr. Shozo YAMAZAKI, Japan Water Works Association (JWWA)
1415 - 1445	Privatization issues	Mr. Peter Cook, NAWC, US
1445 - 1515	General discussion	Japan/US
1515 - 1530	Break	
1530 - 1600	Water reuse	Mr. Yutaka SUZUKI, Team Leader, Material and Geotechnical Engineering Research Group, PWRI, Japan (wastewater) Mr. Toru YOSHIDA, Manager of Engineering Development, Sewerage Bureau, Sapporo, Japan (wastewater)
1600 - 1630	Water reuse	Steve Hayashi, WERF, US
1630 - 1700	General discussion	Japan/US
1700 - 1730	Consideration of Meeting summary	Japan/US
1730 - 1740	Closure/Closing remarks	Japan/US

別添 3 第 2 回日米水道水質管理及び下水道技術に関する政府間会議会議参加者名簿

List of Participants

Japan/US Governmental Conference

October 2002

United States

Mr. Edmund G. Archuleta
El Paso Water Utilities
1154 Hawkins Blvd.
El Paso, TX 79925-6436
Phone: (915) 594-5501
Fax: (915) 594-5666
Email: earchuleta@epwu.org

Dr. James A. Goodrich
USEPA
26 W. Martin Luther King Dr.
Cincinnati, OH 45268
Phone: 513.569.7605
Fax: 513.569.7185
Email: goodrich.james@epa.gov

Mr. Jung Choi
Philadelphia Water Department
1500 E Hunting Park Ave, B
Philadelphia, PA 19124-4941
Phone: 215.685.1407
Fax: 215.743.5594
Email: jung.choi@phila.gov

Mrs. Sally Gutierrez
USEPA
26 W. Martin Luther King Blvd.
Cincinnati, OH 45268
Phone: 513.569.7683
Fax: 513.569.7327
Email: gutierrez.sally@epa.gov

Dr. Stephen W. Clark
USEPA
1200 Pennsylvania Ave NW
Washington, DC 20460
Phone: 202.564.3784
Fax:
Email:

Mr. Stephen T. Hayashi
Union Sanitary District
5072 Benson Road
Union City, VA 94587-2508
Phone: 510.477.7502
Fax: 510.477.7501
Email: steve_hayashi@unionsanitary.com

Mr. Peter Cook
National Association of Water Companies
1725 K Street NW, Ste 1212
Washington, DC 20006
Phone: 202.833.8383
Fax: 202.331.7442
Email: peter@nawc.com

Mr. James F. Manwaring
Awwa Research Foundation
6666 W. Quincy Ave.
Denver, CO 80235
Phone: 303.347.6102
Fax: 303.730.0851
Email: jmanwaring@awwarf.com

List of Participants
Japan/US Governmental Conference
October 2002

Dr. Jennifer McLain
USEPA (4601)
1200 Pennsylvania Ave NW
Washington, DC 20460
Phone: 202.564.5248
Fax: 202.564.3767
Email: mclain.jennifer@epa.gov

Ms. Kathleen Schenck
USEPA
26 W. Martin Luther King Blvd.
Cincinnati, OH 45268
Phone: 513.569.7947
Fax: 513.569.7185
Email: schenck.kathleen@epa.gov

Dr. John Thomas Novak
Virginia Polytechnic Institute & State
University
419 New Engineering Building
Blacksburg, VA 24061-0246
Phone: 540.231.6132
Fax: 540.231.7916
Email: jtnov@vt.edu

Mr. Glenn Reinhardt
WERF
601 Wythe St.
Alexandria, VA 22314
Phone: 703.684.2494
Fax: 703.299.0742
Email: greinhardt@werf.org

Ms. Tyler Richards
Gwinnett County Department of Public
Utilities
684 Winder Highway
Lawrenceville, GA 30045-5012
Phone: 678.376.6923
Fax: 678.376.6717
Email: richarty@co.gwinnett.ga.us

List of Participants
Japan/US Governmental Conference
October 2002

Japan (Drinking Water)

Dr. Ryoji TAKAHARA
Director General, Health Service Bureau,
Ministry of Health, Labour and Welfare
1-2-2 Kasumigaseki Chiyoda-ku, Tokyo
100-8916 Japan
Phone : +81-3-5253-1111 ext.2300
Fax : +81-3-3591-9585
Email : takahara-ryouji@mhlw.go.jp

Dr. Ryutaro YATSU
Director, Water Supply Division, Health
Service Bureau, Ministry of Health, Labour
and Welfare
1-2-2 Kasumigaseki Chiyoda-ku, Tokyo
100-8916 Japan
Phone : +81-3-5253-1111 ext.4021
Fax : +81-3-3503-7963
Email : yatsu-ryuutarou@mhlw.go.jp

Mr. Kazumi KISHIBE
Director, Office of Drinking Water Quality
Management, Water Supply Division,
Health Service Bureau, Ministry of Health,
Labour and Welfare
1-2-2 Kasumigaseki Chiyoda-ku, Tokyo
100-8916 Japan
Phone : +81-3-5253-1111 ext.4031
Fax : +81-3-3503-7963
Email : kishibe-kazumi@mhlw.go.jp

Dr. Shoichi KUNIKANE
Director, Department of Water Supply
Engineering, National Institute of Public
Health, Ministry of Health, Labour and
Welfare
4-6-1 Shirokanedai Minato-ku, Tokyo
108-8638 Japan
Phone : +81-3-3441-7111 ext.268
Fax : +81-3-3446-7161
Email : kunikane@niph.go.jp

Dr. Masanori ANDO
Director, Division of Environmental
Chemistry, National Institute of Health
Science, Ministry of Health, Labour and
Welfare
1-18-1 Kamiyoga Setagaya-ku, Tokyo
158-8501 Japan
Phone : +81-3-3700-9291
Fax : +81-3-3700-9291
Email : ando@nihs.go.jp

Dr. Takuro ENDO
Director, Department of Parasitology,
National Institute of Infectious Diseases,
Ministry of Health, Labour and Welfare
1-23-1 Toyama Shinjuku-ku, Tokyo
162-8640 Japan
Phone : +81-3-5285-1111 ext.2731
Fax : +81-3-5285-1173
Email : tendo@nih.go.jp

Prof. Yasumoto MAGARA
Professor, Hokkaido University
Kita 13, Nishi 8, Kita-ku, Sapporo
060-8628 Japan
Phone : +81-11-706-7278
Fax : +81-11-706-7278
Email : magara@eng.hokudai.ac.jp

Mr. Yoshito MAKITA
Director for Special Programs, General
Affair Division, Bureau of Waterworks,
Tokyo Metropolitan Government
2-8-1 Nishi-shinjuku Shinjuku-ku, Tokyo
163-8001 Japan
Phone : +81-3-5320-6342
Fax : +81-3-5388-1678
Email :
keikaku@waterworks.metro.tokyo.jp

List of Participants
Japan/US Governmental Conference
October 2002

Mr. Hideki HAYASHI
Director, Water Treatment Technology
Division, Japan Water Research Center
2-8-1 Toranomon Minato-ku, Tokyo
105-0001 Japan
Phone : +81-3-3597-0212
Fax : +81-3-3597-0215
Email : uwhayashih@mail.mizudb.or.jp

Mr. Takashi SASAKI
Director, Distribution Division, Hanshin
Water Supply Authority
3-20-1 Nishi-okamoto higashinada-ku, Kobe
658-0073 Japan
Phone : +81-78-431-4355
Fax : +81-78-431-2695
Email : sasaki-t@hansui.or.jp

Mr. Shozo YAMAZAKI
Japan Water Works Association
4-8-9 Kudan-minami Chiyoda-ku, Tokyo
102-0074 Japan
Phone : +81-3-3264-2554
Fax : +81-3-3264-2237
Email : suishitsu@jwwa.or.jp

List of Participants
Japan/US Governmental Conference
October 2002

Japan (Wastewater)

Mr. Hisataka SOKAWA
Director General, Sewerage and Wastewater
Management Department, City and Regional
Development Bureau, Ministry of Land,
Infrastructure and Transport
2-1-3 Kasumigaseki, Chiyoda-ku, Tokyo
100-8918 Japan
Phone : +81-3-5253-8072
Fax : +81-3-5253-1596
Email : sookawa-h24r@mlit.go.jp

Dr. Masahiro TAKAHASHI
Research Coordinator for Water Quality
Control, Water Quality Control Department,
National Institute for Land and
Infrastructure Management, Ministry of
Land, Infrastructure and Transport
1 Asahi, Tsukuba, Ibaraki, 305-0804 Japan
Phone : +81-298-64-3726
Fax : +81-298-64-2817
Email : takahashi-m92es@nilim.go.jp

Mr. Osamu FUJIKI
Director of Watershed Management,
Sewerage and Wastewater Management
Department, City and Regional
Development Bureau, Ministry of Land,
Infrastructure and Transport
2-1-3 Kasumigaseki, Chiyoda-ku, Tokyo
100-8918 Japan
Phone : +81-3-5253-8431
Fax : +81-3-5253-1596
Email : fujiki-o2iv@mlit.go.jp

Dr. Hiroaki MORITA
Head, Wastewater System Division, Water
Quality Control Department, National
Institute for Land and Infrastructure
Management, Ministry of Land,
Infrastructure and Transport
1 Asahi, Tsukuba, Ibaraki, 305-0804 Japan
Phone : +81-298-64-2328
Fax : +81-298-64-2817
Email : morita-h92er@nilim.go.jp

Mr. Shigeru MIYAHARA
Director, Water Quality Control Department,
National Institute for Land and
Infrastructure Management, Ministry of
Land, Infrastructure and Transport
1 Asahi, Tsukuba, Ibaraki, 305-0804 Japan
Phone : +81-298-64-3726
Fax : +81-298-64-2817
Email : miyahara-s92ep@nilim.go.jp

Mr. Hiromasa YAMASHITA
Senior Researcher, Wastewater and Sludge
Management Division, Water Quality
Control Department, National Institute for
Land and Infrastructure Management,
Ministry of Land, Infrastructure and
Transport
1 Asahi, Tsukuba, Ibaraki, 305-0804 Japan
Phone : +81-298-64-3933
Fax : +81-298-64-2817
Email : yamashita-h2ca@nilim.go.jp

List of Participants
Japan/US Governmental Conference
October 2002

Mr. Yutaka SUZUKI
Team Leader, Recycle, Material and
Geotechnical Engineering Research Group,
Pubic Works Research Institute
1-6 Minamihara, Tsukuba, Ibaraki
305-8516 Japan
Phone : +81-298-79-6764
Fax : +81-298-79-6797
Email : ysuzuki@pwri.go.jp

Dr. Hiroaki TANAKA
Team Leader, Water Quality, Water
Environment Research Group, Pubic Works
Research Institute
1-6 Minamihara, Tsukuba, Ibaraki
305-8516 Japan
Phone : +81-298-79-6776
Fax : +81-298-79-6748
Email : htanaka@pwri.go.jp

Prof. Chikashi SATO
JSPS Invitation Fellow, Water Quality,
Water Environment Research Group, Pubic
Works Research Institute
(Associate Professor, College of
Engineering, Idaho State University)
1-6 Minamihara, Tsukuba, Ibaraki
305-8516 Japan
Phone : +81-298-79-6777
Fax : +81-298-79-6748
Email : satou55@pwri.go.jp

Dr. Haruki WATANABE
Director of Research and Technology
Development Department, Japan Sewage
Works Agency
5141 Shimosasame, Toda, Saitama
335-0037 Japan
Phone : +81-48-421-2693
Fax : +81-48-421-7542
Email : WatanabeH@jswa.go.jp

Mr. Tadashi TAKESHIMA
Director of Industrial Wastewater Guidance
Section, Customer Service Division, Bureau
of Sewerage, Tokyo Metropolitan
Government
2-8-1 Nishi-Shinjuku, Shinjuku-ku, Tokyo
163-8001 Japan
Phone : +81-3-5320-6584
Fax : +81-3-5388-1704
Email :
t_takeshima01@gesui.metro.tokyo.jp

Mr. Toru YOSHIOKA
Manager of Engineering Development,
Planning Section, Construction Department,
Sewerage Bureau, Sapporo Municipal
Government
3-2-1 Toyohira-6-jo, Toyohira-ku, Sapporo,
062-8570 Japan
Phone : +81-11-818-3441
Fax : +81-11-812-5224
Email : ge.keikaku@gesui.city.sapporo.jp

**The 2nd Japan/US Governmental Conference on
Drinking Water Quality Management and Wastewater Control**

Meeting Summary

Oct. 23, 2002

Mita Kaigisho, Tokyo, Japan

1. The 2nd Japan/US Governmental Conference on Drinking Water Quality Management and Wastewater Control was held in Tokyo, Japan from October 21 to 23, 2002. It was attended by 13 participants from US and 23 participants from Japan. (See the Participants List attached hereto.)

2. The Meeting was opened by the welcome address by Dr. Takahara, Director-General, Health Service Bureau, Ministry of Health, Labour and Welfare and Mr. Sokawa, Director-General, Sewerage and Wastewater Management Department, Ministry of Land, Infrastructure and Transport. Responding them, Mrs. Gutierrez, Director of Water Supply and Water Resources Division, National Risk Management Research Laboratory made opening remarks.

3. Following moderators were appointed to facilitate the discussions.

	AM	PM
Oct.21	Dr. Ryutaro Yatsu	Dr. Syoichi Kunikane
22	Mr. Glenn Reinhardt	Dr. James Goodrich
23	Dr. Masahiro Takahashi	Dr. Haruki Watanabe

4. Presentations on following topics were made by Japan side and US side respectively and after the presentations participants actively discussed about the topic;
 - Overview of drinking water quality management and wastewater control
 - Current and future regulatory issues in drinking water
 - Issues in watershed protection/ source water protection/ storm water flows
 - Research agenda in drinking water/ wastewater control
 - QA/QC for the monitoring of drinking water quality
 - Arsenic (in drinking water)
 - Microbial water quality control
 - Endocrine Disrupting chemicals
 - Water security issues/ seismic design issues
 - New treatment trends
 - Global and environmental consideration in drinking water supply and wastewater control
 - Privatization issues
 - Water reuse

5. As result of this meeting, both delegates reached a consensus to address the importance of these approach;
 - Both countries are now facing complicated problems surrounding our water environment, especially in chemical and microbial aspects, and remaining problems will be more

- difficult to resolve than previous years,
- To control human risk as well as ecological risk, holistic approach taking into consideration various aspects including watershed protection, treatment, distribution system, rehabilitation of the facilities is needed,
 - In planning process, prioritizing based on latest scientific knowledge is essential, and in implementation stage, science-based decision making becomes more important particularly in communication with each stakeholder providing adequate information on risk management taking into account cost-benefit,
 - Cooperative actions among research community, water utilities and policy making agencies are important, and
 - Information exchange between the US and Japan is truly beneficial in terms of sharing experiences and ideas.

(Next Meeting)

6. Participants shared the view that the meeting would provide an invaluable forum for free exchange of views and information among them, and greatly contribute to drinking water quality management as well as wastewater control technologies in both countries. The results of this conference have made a significant contribution to water resources management that is an environmental problem not only in the two participating nations, but also throughout the world. Therefore, it was agreed that the next conference should be held in US on rotation basis in 2004 and that meetings and seminars in some specific areas should be held in the interim. It was also agreed that the modalities would be determined later through consultations between both sides. In order to prepare the next conference, Ms. Schenck, Dr. Kunikane and Mr. Miyahara were appointed to be contact persons for US and Japan, respectively.

The following specific areas have been also agreed upon for future discussion:

- Watershed protection/ source water protection/ storm water flows
- Microbial water quality control
- Endocrine disrupting chemicals
- Water security
- Rehabilitation of the facilities
- Global and environmental consideration
- Best management practices in the water/ wastewater industry

Welcome speech

October 21, 2002

Sokawa Hisataka
Director General of Sewerage and Sewage Purification Department
Ministry of Land, Infrastructure and Transport, Government of Japan

I am very honored to meet you here.

The US-Japan Committee on Sewage Treatment Technology that was established under the agreement of the Meeting of US-Japan Cabinet Ministers in Charge of Environmental Pollution in July 1971 succeeded to the Committee based on the US-Japan Environment Cooperation Agreement.

At that time the United States had just started many construction projects of wastewater treatment plants having conventional secondary treatment processes, while Japan was the dawn of a new era when it began extensive construction of many sewerage systems because only about ten percent of the nation could use public sewerage systems.

Japan has developed its sewerage installations so far, and has now 63.5% of the population who can use public sewerages.

Such a change of conditions has led both countries to expand their views and interests from sewage treatment technology alone to non-point source control such as combined sewer overflows and water quality management issues on the basis of watersheds, including receiving waters from sewerage systems.

Recently, control of pathogens such as *Cryptosporidium* and endocrine disrupting chemicals are becoming more important than before because they are great concerns to water supply, recreational activities, and ecological protection when receiving waters discharged from upstream sewerage systems.

Control of pollutant loads in combined sewer overflows and stormwater during wet weather is also increasing in importance, when water quality management is viewed on the basis of watersheds.

Coping with increasing water demand in urban areas and maintaining sound water flow of rivers is gradually enhancing the importance of wise reuse of treated wastewater as water resources.

The watershed view is a key to solve these challenges.

Therefore, it is undoubted that mutual exchange of information and discussion of countermeasures beyond a boundary of water supply and sewage works in United States and Japan are quite significant for international views as well as for the views of both countries.

After the 1st conference held in Colorado Springs in 1999, we have dealt with various issues related to the watershed management.

We are making technical guideline for control of *Cryptosporidium* in sewage.

We also executed fact-finding study program with respect to endocrine disrupting chemicals in rivers and sewerages, and investigation for assessing their effects on organisms.

Concerning the CSO control, we started a strategic project for technological development that is called SPIRIT 21.

In this conference, we would like to introduce present situation concerning various issues, and we would like to discuss them profoundly.

The 3rd World Water Forum will be held in Japan in March 2003.

Watershed management issues will become one of main topics of the World Water Forum.

I hope the discussion carried out here will enhance the success of the forum more and more.

After the last conference, we experienced the beginning of 21st century.

We also experienced the reorganization of the ministry and agency of Japanese government.

Our feeling was refreshed, but issues are increasing.

I hope this conference will bring us about fruitful results.

I hope that earnest discussions in this conference will also bring about opportunities for both countries' collaborative research activity in the future.

Thank you.

別添 6 会議および視察での写真



写真一 1 会議の様子 (三田共用会議所)



写真一 2 参加者の集合写真 (同左)

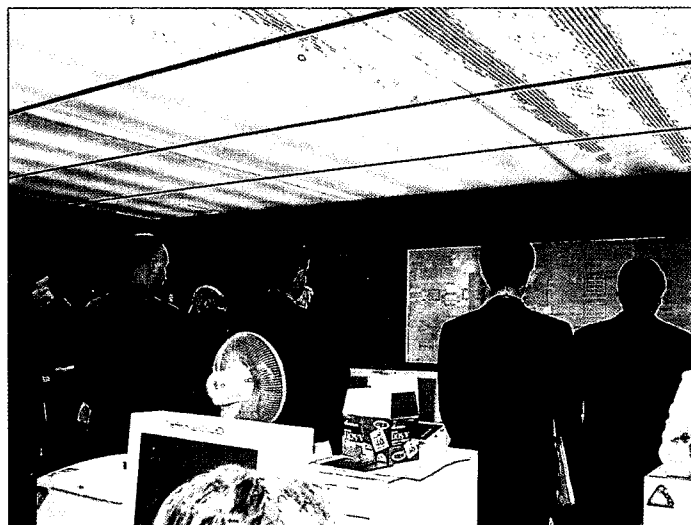

写真一 3 中央監視室 (三郷浄水場)



写真一 4 オゾン処理設備 (三郷浄水場)



写真一 5 再生水による修景施設 (有明処理場)



写真一 6 調査団一行 (有明処理場)

発表論文等

1.Overview of Drinking Water Quality Management

Presenter

Dr. Ryutaro YATSU, Ministry of Health, Labour and Welfare

Overview of Drinking Water Quality Management in Japan

Japan-U.S. Governmental Conference on
Water Quality Management and Wastewater Control
21-23 October 2002
Tokyo, Japan

Dr. Ryutaro YATSU
Director, Water Supply Division
Ministry of Health, Labour and Welfare

1. Introduction

It has been over 100 years since modern piped water supply system was introduced into Japan. It covers 96.6% of whole population up to now, and has greatly contributed to the promotion of public health. On the other hand, there still remain issues to be dealt with in terms of drinking water quality management as well as management of water supply system itself.

This paper briefly introduces the drinking water quality management system in Japan and progress made during intersessional period.

2. Characteristics of water supply in Japan

2.1 Development of modern water supply system

The modern water supply system was originally introduced into Yokohama city in 1887 with the aim of preventing infectious disease through drinking water such as cholera and typhoid fever prevailing in the mid 1800s. The modern system was developed in harbor cities at the first step and has gradually spread all over Japan. Especially, remarkable development was achieved after the World War II. The percentage of population served increased from 53.4 percent in 1960 to 96.6 percent in 2000.

In addition, infectious disease decreased dramatically, following the development of modern water supply from piped water.

2.2 Water demand

Water demand increased with improvement of living standards, development of sewage system, concentration of population to urban areas. But lately it has reached its peak because of economical stagnation, and prevailing water reuse and so on.

2.3 Water resource

Drinking water mainly comes from surface water, especially of river waters. (Surface water: 71%, ground water: 26%). Many reservoirs as water resources have been constructed. As a result, dependence on reservoirs has been increasing year by year and it covers about 40% of whole water resources. On the other hand, dependence on ground water including shallow well, deep well and river-bed water remains unchanged in ten years.

In respect of water quality in public water bodies, about 80% of those are compliant with the environmental standards of organic pollution (BOD in rivers, and COD_{Mn} in lakes and coastal water).

2.4 Water purification

A lot of water suppliers adopt rapid sand filtration system in Japan, because surface water is major source of drinking water. Recently, some water suppliers, especially the ones of large-scale water suppliers, have introduced advanced water treatment processes such as activated carbon treatment and ozonization in addition to a conventional rapid sand filtration system.

As for ground water treatment, most treatment plants have no treatment facility with the exception of chlorination system, because the quality of ground water seems to be fairly well.

2.5 Trend of water quality issues

One of the main purposes of introducing water supply systems was prevention of waterborne infectious diseases caused by pathogenic microorganisms like cholera. This is still very important, even if most people care nothing about it.

After World War II, many kinds of chemicals got to be used and a matter of concern was also changed from pathogenic microorganisms to chemicals such as

industrial effluents and pesticides. The latest issues to be dealt with are chlorine-resistant microorganisms like *Cryptosporidium*, disinfection by-products, and trace chemicals such as dioxins and endocrine disruptors.

3. Legislation and institution

3.1 Legislations

Various laws concerning water supply facilities and services have been promulgated to cover the different aspects.

a. Water Works Law

The basic law concerning water supply is the Water Works Law which was enacted in 1957, and on the basis of this, National Government (Ministry of Health, Labour and Welfare) or prefectures authorize the business license to water suppliers.

b. Basic Environment Law

In point of conserving the quality of water resources, based on the Basic Environment Law, Environmental Quality Standards for water quality in public water bodies and ground water are set as target levels of water quality to be achieved and maintained.

c. Water Pollution Control Law

The Water Pollution Control Law lays down uniform national effluent standards for specified facilities discharging effluents into public water bodies. It also regulates hazardous waste should not be discharged on the ground.

d. Law on Promotion for Water Quality Protection at Source

The Law on Promotion for Water Quality Protection at Source was promulgated in order to conserve water resources. When water suppliers fail to meet Drinking Water Quality Standards (DWQSs) through their own effort like upgrading their treatment method, they may ask prefectures or river administrator to formulate a promoting plan for constructing public sewerage system, individual sewage treatment

installations, river facilities for improving surface water quality, and controlling THMs precursors.

3.2 Institutions on water supply

On the basis of Water Works Law, National Government (Ministry of Health, Labour and Welfare) or prefecture authorize the business license to water suppliers and supervise depending on the scale of suppliers. To be more precise, MHLW supervise water suppliers that supply to more than 50,000 people and bulk water suppliers that have more than 25,000m³/day water supply, and prefectures supervise smaller water suppliers and bulk water suppliers. Prefectures also control private water supply system and small-scale water supply system.

3.3 Water quality management system in Japan

The main purpose of water supply is to provide safe drinking water. So all drinking water provided by water supply systems should comply with the DWQSS stipulated by the Article 4 of the Water Works Law. The DWQSS have 29 parameters on human health and 17 parameters on acceptability of drinking water. And parameters for desirable taste and parameters for monitoring are set. Also this law establishes several provisions to secure proper facilities and management measure.

In respect of proper facilities, it establishes the following.

- Technological facility standards
(possession of treatment system to get adequate water compliant with drinking water quality, etc.) [Article 5]
- Supervision of the construction of facilities by engineers [Article 12]
- Test of water supply facilities and water quality prior to the start of water supply service [Article 13]
- Standards on plumbing [Article 16 etc.]

In respect of management measure, it establishes the following.

- Appointment of water supply engineering supervisor [Article 19]
- Regular and ad hoc water quality analysis [Article 20]
- Health check of employees [Article 21]

- Sanitary measures (disinfection) [Article 22]
- Emergency suspension of water supply when supplied water is suspected to be harmful to human health [Article 23]

4. Problems on water supply systems

4.1 Quantity Aspect

The balance of water demand and supply has been improved by the effort of construction of dams. But now, construction of a new dam and a reservoir becomes difficult in most areas due to shortage of suitable sites and opposition by inhabitants, and it is vital to utilize existing water resources as effectively as possible to achieve sustainable supply of drinking water.

4.2 Quality Aspect

It becomes more important to strengthen the water quality management system, because the quality of water resources is deteriorated, resulting from the pollution of river and ground water by effluent of domestic wastewater and chemical substances.

In addition, not only the water quality management system but also conserving water resources is the key issue. Although some counter-measures have been promoted in some area based on the Law on Promotion for Water Quality Protection at Source, improvement is not necessarily sufficient all over Japan. Therefore it is crucial to promote counter-measures cooperating with environment, river and sewage water administration.

4.3 Technical and financial capacity

Especially small water suppliers face various problems in keeping their proper management of facilities, water quality and crisis, because of their weak technical and financial capacity.

Although it is very important to renew facilities according to plan and strengthen anti-seismic measure, there are many water suppliers unable to invest enough funds. Strengthening technical and financial capacity of water suppliers is important so that they supply safe water sustainably.

5. New measures

5.1 Amendment of the Water Works Law

As noted above, most of water suppliers are small municipalities, and their financial and technical capabilities remain low. There were some outbreaks of infectious disease resulting from supplied water.

The Water Works Law was amended last year. One of major points is to systematize the entrustment of management practices to the third parties in order to strengthen the management system of water suppliers. Another is to simplify licensing procedures for merging water suppliers. This amendment also aims to take measures for a stronger management system covering unregulated water supply system with many users and water supplied from receiving water tanks from the viewpoint of securing drinking water.

5.2 Comprehensive review of water quality standards

Current DWQs were set for 46 items in 1992. In March 2002, it was announced officially that the standard value for lead would be strengthened from 0.05 mg/L to 0.01 mg/L as of April 2003.

Parameters for Monitoring were set for 26 items in 1992, and 6 items were added afterward. Besides, in the wake of Special Measures Law on Dioxins, the provisional value of Dioxins (1 pg-TEQ/L) was added in 1999 from the viewpoint of securing drinking water. And the value of Chlorine dioxide (0.6mg/L) and that of Chlorite (0.6mg/L) were added in 2000 to secure water with using Chlorine dioxide as a disinfectant.

DWQs in Japan are now being reviewed comprehensively taking into account of the revision of WHO's Guidelines of Drinking Water Quality in 2003.

6. Conclusions

Since the previous conference in Colorado Springs, a number of measures to conserve water quality have been taken. However, there are several issues yet to be tackled. Therefore we expect that the conference will contribute better mutual understandings and closer cooperation for both countries through information exchange and discussion with wider point of view.

Overview of Drinking Water Quality Management

Ryutaro YATSU, Ph.D.
 Water Supply Division
 Health Service Bureau
 Ministry of Health, Labor and Welfare

1. Characteristics of Water Supply In Japan

History of Modern Waterworks

- 1887: The first modern waterworks in Yokohama City. (iron pipes, pumps, sand filters)
- 1889: Hakodate City
- 1891: Nagasaki City
- 1895: Osaka City
- 1898: Tokyo (Ports and big cities)

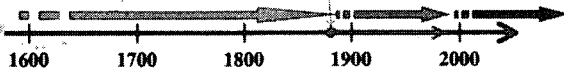

Water Supply and Infectious Diseases

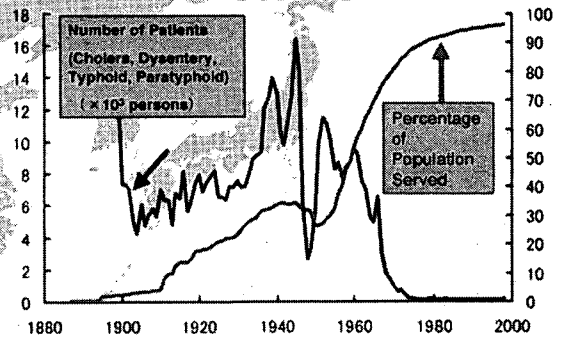

Increase of Population Served

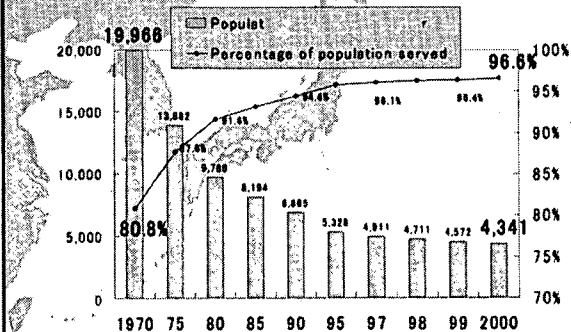

Water Demand

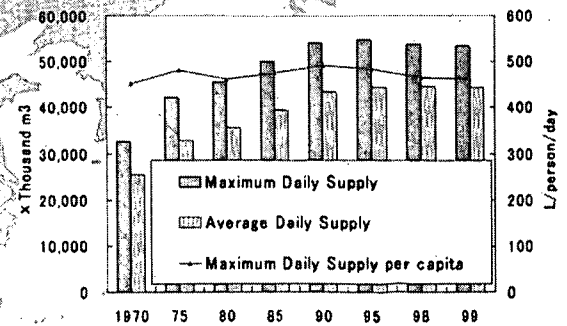

Classification of Water Sources

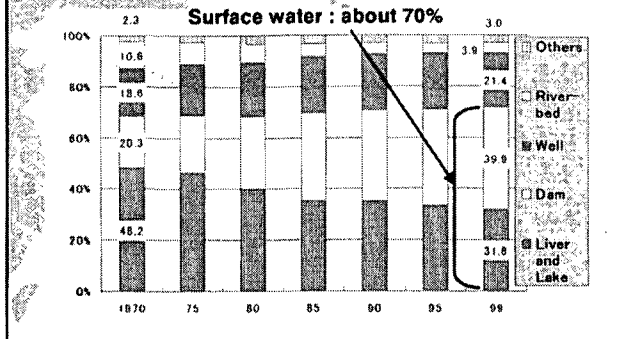

Water Quality in Public Water Bodies

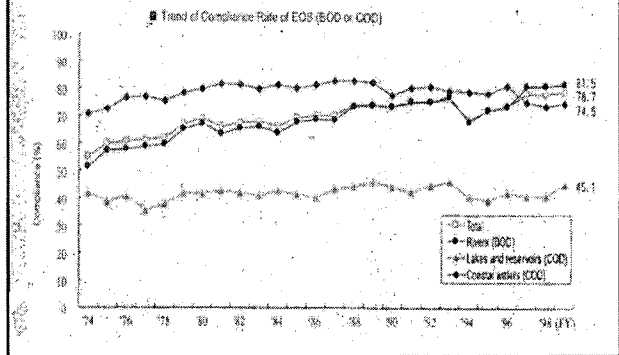

Water Purification

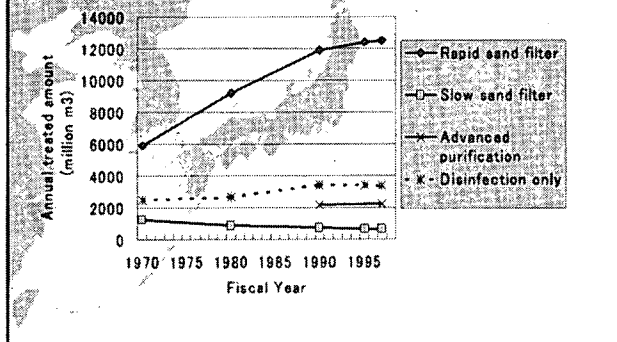

Trend of Water Quality Issues

- Late 19th century -
Cholera and other microorganisms
- 20th century
Microorganisms → chemicals
- Late 20th century -
Disinfectant by-products
Cryptosporidium
Trace chemical substances

2. Legislations and Institutions

Legislations

- **Basic law : Water Works Law**
 - Enacted in 1957, latest amendment in 2001
- **Related laws**
 - **Quality Control on Water Resource**
 - The Basic Environment Law
 - Water Pollution Control Law
 - Lake Law
 - Law on Promotion For Water Quality Protection at Source
 - Law on Special Measures for Preventing Water Source Pollution
 - **Others**
 - Laws on water resources development, management / land and urban planning, loan and Labour relation ...

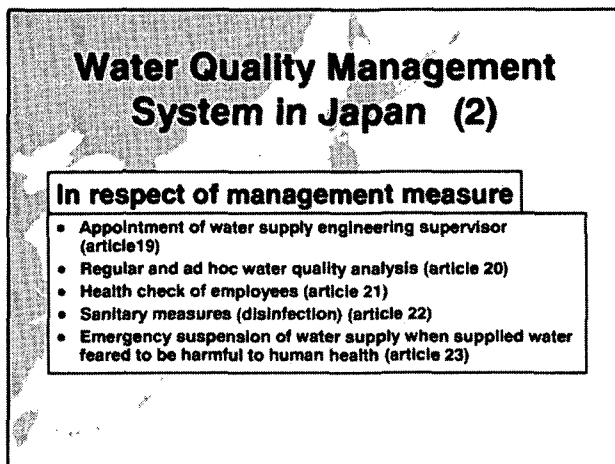
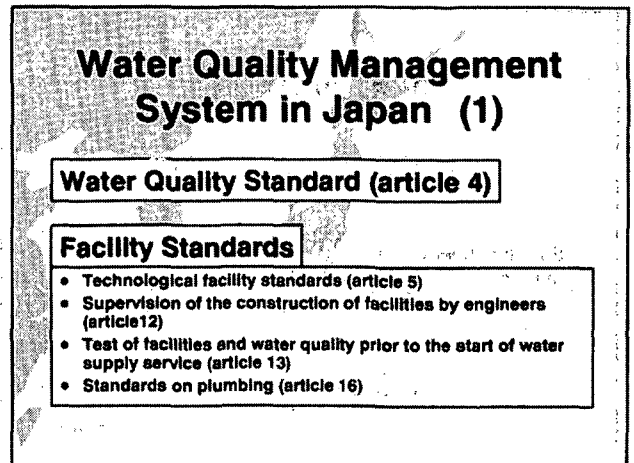
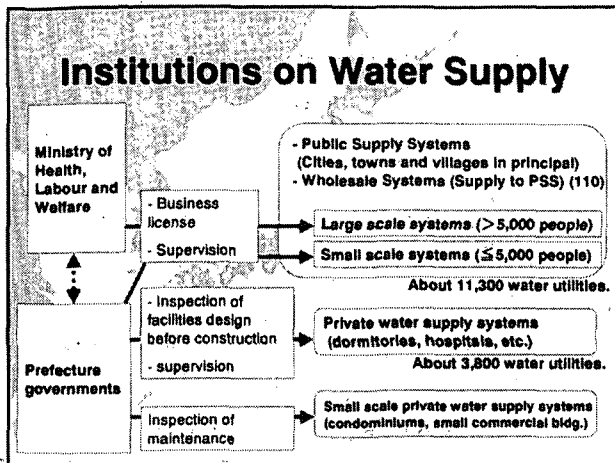

Water Quality Standards

Standards designated by Waterworks Law	<ul style="list-style-type: none"> • 29 parameters on human health • 17 parameters on acceptability of drinking water 	<ul style="list-style-type: none"> • Standard plate count • Coliform count • Cd • Hg • Se • Odor <p style="text-align: right;">etc.</p>
Parameters for Desirable Taste	13 parameters	<ul style="list-style-type: none"> • Mn • Al • Residual chlorine • Free carbon dioxide • Organic substances • Total residue <p style="text-align: right;">etc.</p>
Parameters for Monitoring	35 parameters	<ul style="list-style-type: none"> • Trans-1,2-dichloroethylene • Toluene • Xylenes • Boron <p style="text-align: right;">etc.</p>

3. Problems on Water Supply Systems and New Measures

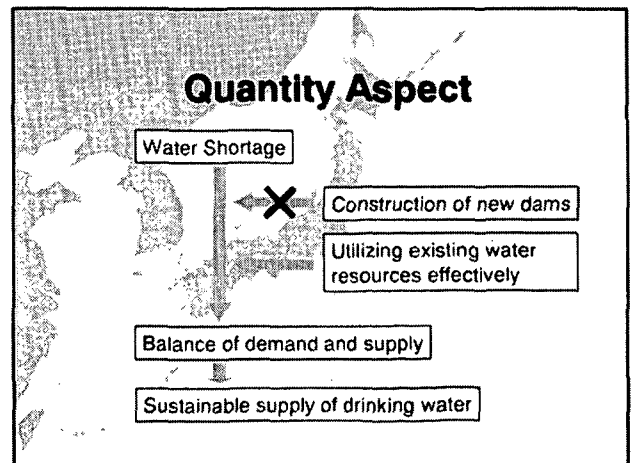

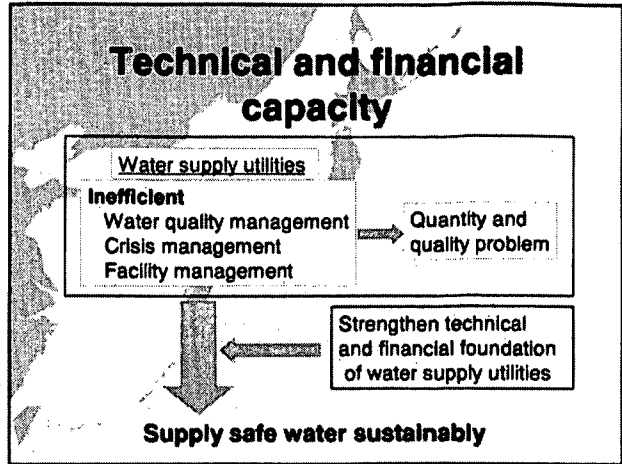
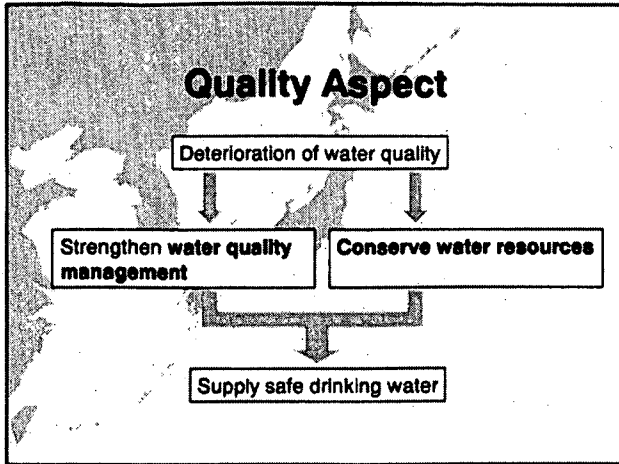

New Measures

- **Amendment of Water Works Law**
 - Enacted in 2002 April
 - Major points:
 - Systematize the entrustment of management practices to the third parties
 - Simplifying licensing procedures for merging water utilities
- **Comprehensive review of Water Quality Standards**
 - WHO guidelines for drinking-water quality is to be revised in 2003
 - Water quality standards will be revised taking into account of the revision of the WHO guidelines

2. Sewage Works Development In Japan

Presenter

**Mr. Osamu Fujiki, Ministry Of Land,
Infrastructure And Transport**

Sewage Works Development in Japan

Osamu Fujiki
Director for Watershed Management
Ministry of Land, Infrastructure and Transport
Japan

1. Abstract

This paper explains the history of construction of sanitary facilities and sewerage system as well as their present situation. Before modernization, Japanese people used to apply night soil from latrine toilet to farmland as a fertilizer, while sewerage was constructed mainly for stormwater drainage. However, as urbanization, industrialization and modernized agriculture progressed, and as the problem of water pollution became more obvious, construction of sewerage centering on the treatment of night soil and household wastewater started in earnest.

Concerning the factors that contributed to the rapid spreading of sewerage in the postwar Japan, it is possible to name the appropriate sharing of responsibilities by the central and the local governments, introduction of public funds, foundation of Japan Sewage Works Agency etc. In addition, the connection duties, tariff system and regulation of industrial wastewater discharged into the sewerage are stipulated under the postwar Sewerage Law, so that the sewerage construction could contribute to improvements in living environment and water quality conservation on a sustainable management basis. The local governments as the sewage works managers are performing such duty, while maintenance-related works that does not involve governmental authority are transferred to many private businesses. In sewage works today, there is a need for advanced treatment and countermeasures against pathogenic microorganisms and micro-pollutants, due to increasing public awareness of environmental issues. New approaches to the legal system based on watershed management might therefore be needed.

2. Introduction

The current state of sewage works in Japan (as of fiscal year 2001) is as follows.

Percentage of sewered population: 63.5% (of total population of 126.48 million) **Fig.1**

Percentage of area adequately served by stormwater drainage system: 50.6%

Number of municipalities conducting sewage works: 2,255 (of total number of 3,224)

Investment in sewerage system: 3.26 trillion yen (cf. GNI = 500.2 trillion yen)

Treatment method: Based on the conventional activated sludge process, more advanced treatment should be performed according to the state of the public water body to which the effluent is discharged.

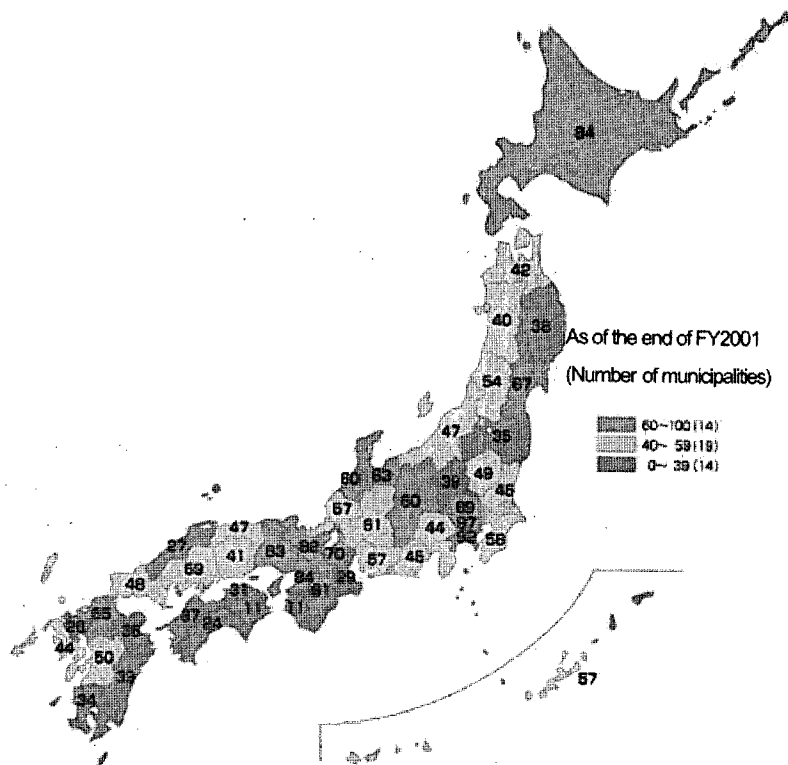

Fig.1 Percentage of Sewered Population (%)

3. History of sanitary system construction in Japan

3-1 History of sanitary system construction

Before entering its industrialized stage, Japan was an agricultural country, and human excreta including those generated in urban areas were used as a fertilizer on farmland without causing any significant problem. As a result, all toilets were the pit latrine type. However, as Japan receives much rainfall, urban districts with many inhabitants constructed water conduit system for drainage. Thus, throughout the country the main purpose of sewerage construction was to drain away storm-water as well as gray water.

With the progress of modernization, however, the human excreta generated in urban districts were not supplied to farmland; urban areas with high concentrations of inhabitants and industries started to suffer problems such as outbreaks of infectious diseases caused by stagnant sanitary sewage and contaminated drinking water sources. To promote the development of sewage works in response to urbanization, the old Sewerage Law was enforced in 1900. At that time, however, the sewerage system did not develop because there was a greater need to build the infrastructure for industrialization with the limited financial resources available, and because there was little public recognition of sewage problems. After World War II, as demand for water rapidly increased, top priority was placed on building the water supply system, and sewerage construction received little attention.

3-2 Rapid increase of sewerage construction after World War II

The present Sewerage Law was enforced in 1958 to establish legal conditions for the construction of sewerage systems as the population and industries in urban districts started to grow rapidly. Furthermore, as water pollution of rivers, lakes, reservoirs and sea areas worsened as a result of rapid economic development, the objective of “conservation of water quality in public water bodies” was added to the Sewerage Law in 1970, and subsequently sewerage construction took off in many cities as fundamental urban facilities.

The government recognized that sewerage systems are a basic national service for all people in Japan, and that such facilities have a beneficial economic impact on other industries and social fields, and so gave financial aid to sewage works projects carried out by local public bodies in the form of national subsidies. In 1963, it settled on the “Five-year Program for the Sewerage Construction” according to the Law to secure a certain amount of investment in sewage works. Up to the 8th Plan currently conducted, it has promoted activities of individual local public bodies, centering on such financial support as governmental subsidies.

However, sewage works involve a wide range of sophisticated technologies, and particularly small local public bodies did not have the requisite engineers. The Japan Sewerage Works Agency was therefore established in 1972 to secure the necessary engineers and to assist local public bodies. (Fig.2)

Since the latter part of the 1970s, the policy of constructing sewage systems centering on the combined sewer system was shifted to the separate sewer system for the new ones to be constructed. That is, sanitary sewage and stormwater flow are handled separately in order to preserve water quality. The number of municipalities that are currently conducting sewage works is 2,225, of the total number of 3,224.

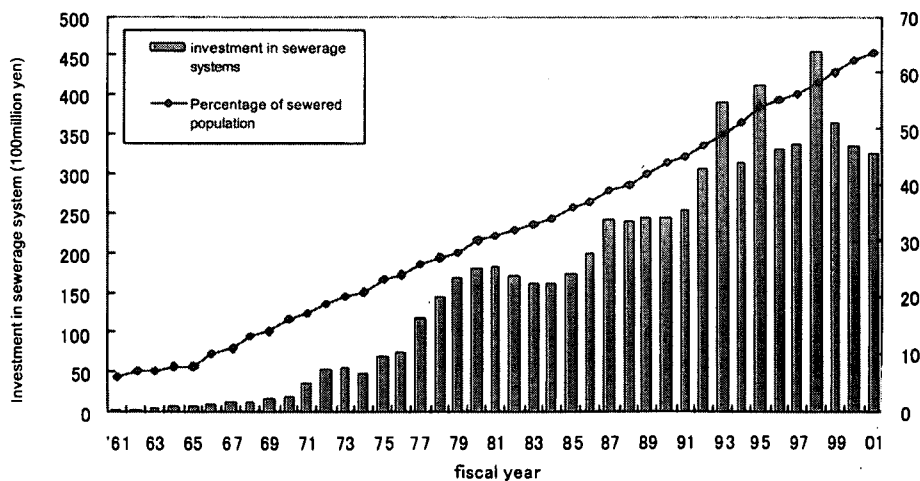

Fig.2 Sewerage Investment Amount and Percentage of Sewered Population

4. Efficient sanitation system construction

- Concept of appropriate treatment of sanitary sewage throughout prefecture areas

The Ministry of Land, Infrastructure and Transport published the “Concept of appropriate treatment of sanitary sewage throughout prefecture areas” in 1993, and has promoted its implementation. The concept covers commercial and industrial wastewater as well as household sanitary sewage, and establishes an optimum combination of two types: public sewerage, which is publicly managed for collective treatment to conserve the water quality in public water bodies; and “johkasou”, which is publicly or privately managed to treat household sanitary sewage separately or collectively relying to regional characteristics. All the prefectures in Japan have already formulated this kind of plan. (Fig.3)

As a reference of the prefectural plan, the Ministry of Land, Infrastructure and Transport issued the “Manual on the prefectural master plan of appropriate wastewater treatment (Draft)”, and, in cooperation with the Ministry of the Environment and the Ministry of Agriculture, Forestry and Fisheries, which are responsible for sanitary wastewater treatment facilities other than public sewerage, prepared and published a standard guideline for economic comparison according to local characteristics.

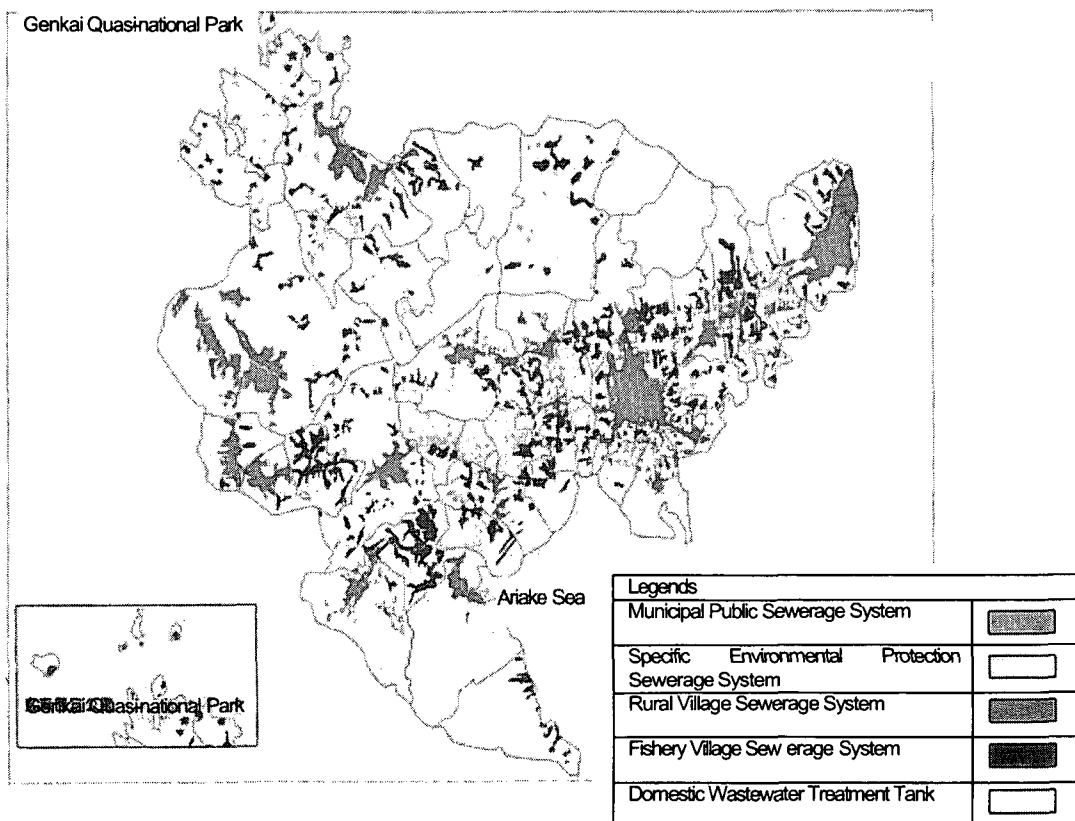

Fig.3 Example of Prefectural Plan for Appropriate Wastewater Treatment (Saga)

The method offers the following benefits.

- (i) Systematic and efficient construction of sanitary sewage treatment facilities
- (ii) Better understanding of sewage works among public bodies that have not adopted appropriate method.
- (iii) Identification of the necessary scale of sewage works as a long-term objective

5. Watershed management approach

5-1 Scheme of Comprehensive Basin-wide Planning of Sewerage System

As in other countries, rivers in Japan are a water source, but also receive sewage and wastewater, which may cause sensitive conflicts of interest between those living in upstream and downstream areas. Such problems relating to the river basin are raising concerns as the quantity of sewage, wastewater, and storm-water coming through the sewerage system has increased following the development and spread of sewerage systems. Hence, the impact and role of sewerage facilities in the control of both water volume and water quality of a basin are particularly important.

Regarding the conservation of water quality of closed water bodies such as lakes and bays, it is essential to limit the total discharge load over the whole area of the basin, not solely limiting the quantity discharged by adjacent local public bodies.

Japan therefore adopts a basin-wide approach in which the national government coordinates issues regarding a basin involving more than one prefecture to determine the share of pollution load elimination. Based on the determined share of load elimination, each prefecture conducts “Comprehensive Basin-wide Planning of Sewerage Systems”, which forms the master plans of sewerage.

The “Comprehensive Basin-wide Planning of Sewerage Systems” is a representative policy for the watershed management in terms of sewerage and set out in the Sewerage Law in 1970. It is a basic plan for sewerage construction regulated by prefectures, covering the public water body whose water pollution is caused by the pollution load flowing in from more than two municipal areas and the plan should be formulated so that the water quality may be improved to fulfill the environment standard mainly through sewerage systems.

5-2 Comprehensive Basin-wide Planning of Sewerage System relating to Osaka Bay

The Osaka Bay basin (**Fig.4**) covers much of Shiga, Osaka, and Nara prefectures and a part of Kyoto, Hyogo, and Mie prefectures. Owing to its geological structure, Osaka Bay, which forms a closed water body with little exchange of sea water, does not satisfy legally specified environmental standards for COD, nitrogen, and phosphorus. (**Fig.5**)

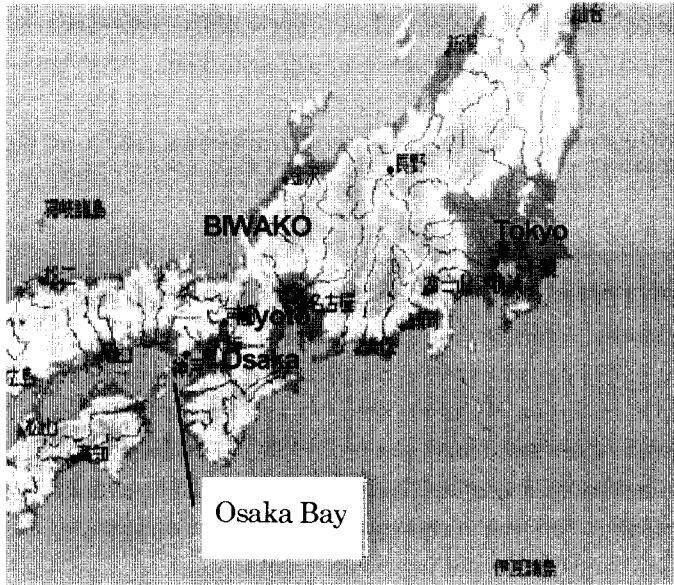

Fig.4 Osaka Bay-Map

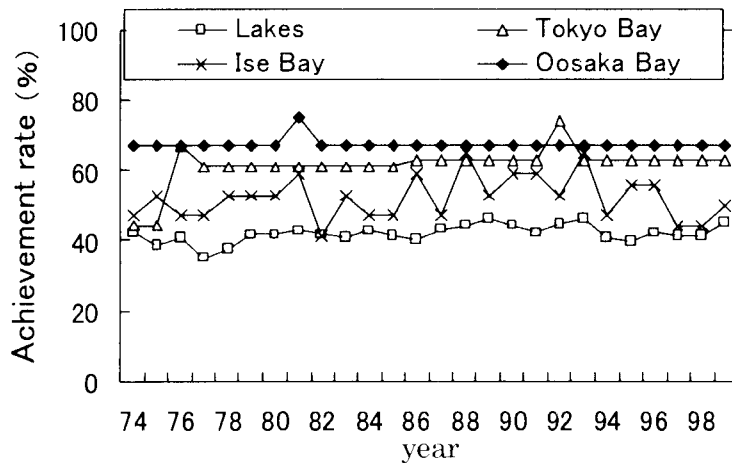

Fig.5 Achievement Rate Change in Environmental Quality Standards (COD) with Lakes and 3 Major Gulfs

In 1995, the Ministry of Land, Infrastructure and Transport issued the policy on the allocation of allowable discharge pollution loads for Kyoto, Osaka, Hyogo, and Nara after long discussion among related prefectures chaired by the Regional Bureau of the Ministry. (Fig. 6, Table 1)

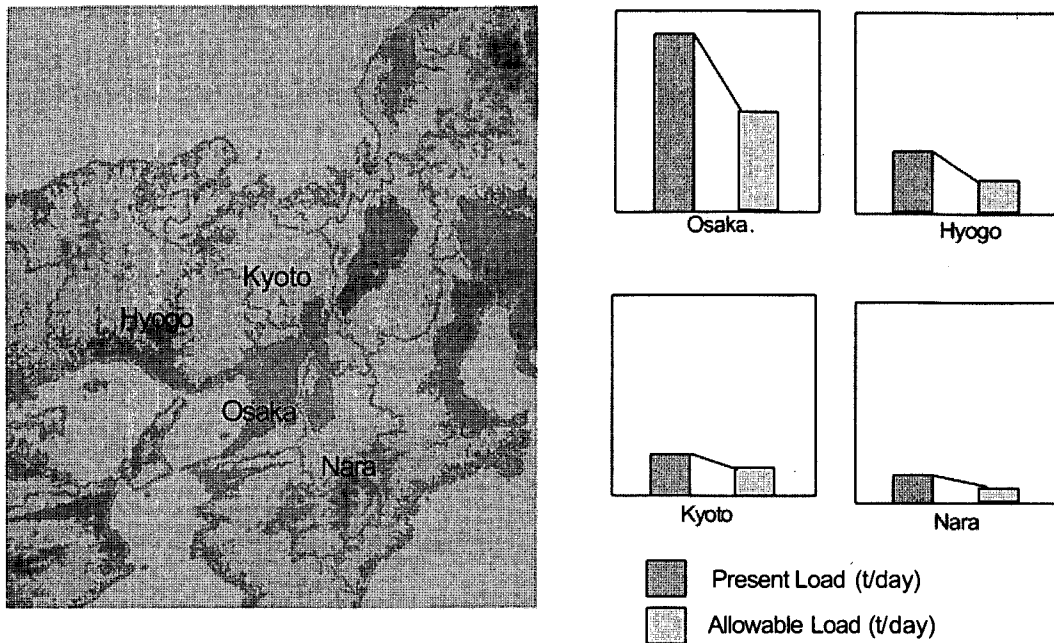

Fig.6 Allocation of Allowable Pollution Load Distribution among Prefectures

Table 1 Result of Allowable Load Allocation among Prefectures (t/d)

Prefecture	COD	T-N	T-P
Kyoto	28	20	2.1
Osaka	100	56	4.8
Hyogo	40	25	2.3
Nara	14	9	0.8
Total	182	110	10

Note: If figures in each item summed up, the value will not be congruous to the figure in "Total" because each figure is rounded off.

Based on the determined share, each prefecture has prepared Comprehensive Basin-wide Planning for the Sewerage System, which covers all sewerage construction in the prefectures concerned. (Fig.7)

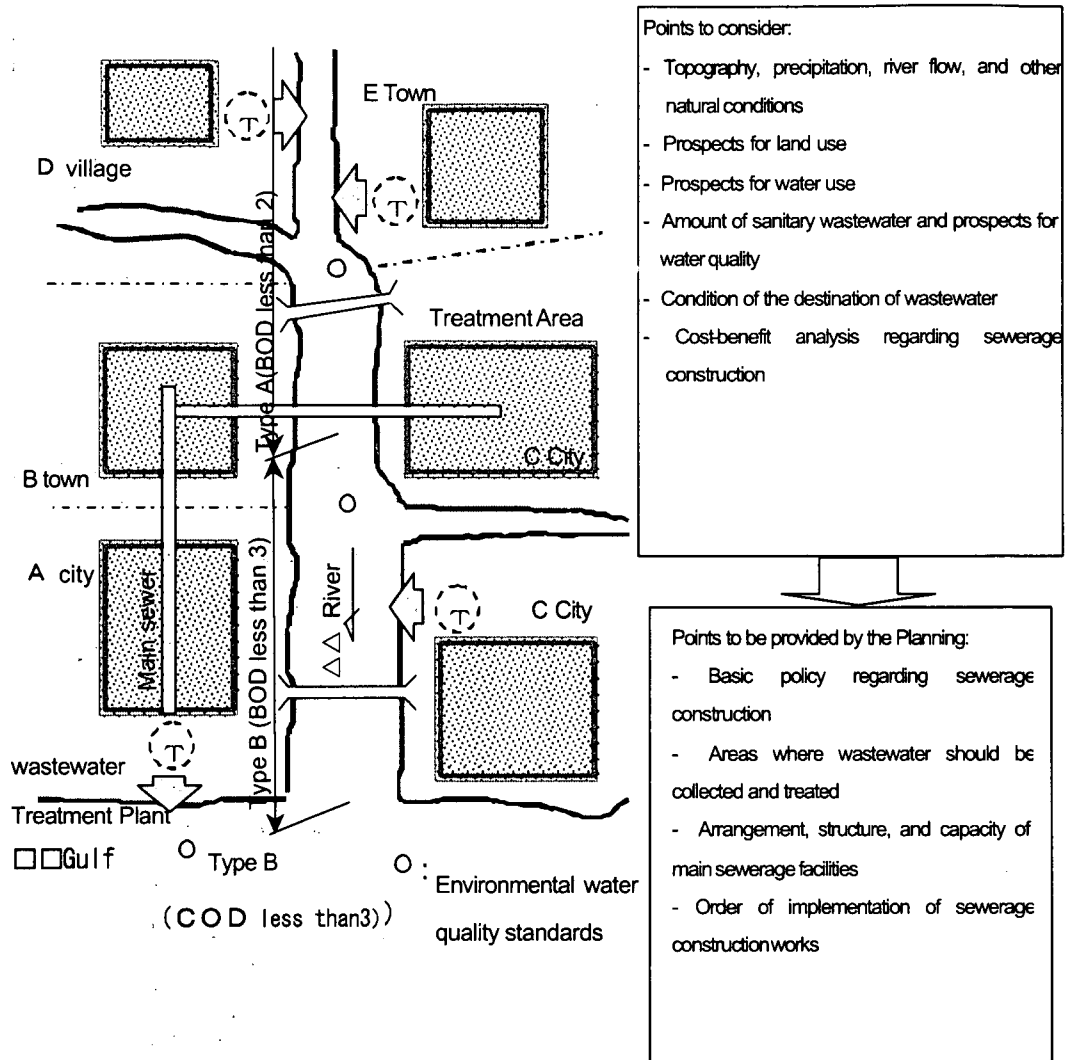

Fig.7 Comprehensive Basin-wide Planning of Sewerage System (outline)

The plan of each prefecture was intended not only to satisfy the standard for the water quality environment of Osaka Bay, but also to satisfy the standard for the water quality environment of the Yodo River, which is an important city water source.

5-3 Existence of risks in water system, which cannot be treated by the Comprehensive Basin-wide Planning of Sewerage System

As the development of the water supply and sewage system progressed by individual local public bodies, there has been an increase in the number of cases where the intake of water by a local public body is located directly downstream of the discharge point of sewage-treated effluent of another upstream local public body, as seen in the case of the Yodo River. The Comprehensive Basin-wide Planning of Sewerage Systems can address only a limited number of targets of the standard for the water quality environment, and focuses only on the average water quality environment concerned, thus the water quality in an emergency is outside its scope.

Various urban and social activities lead to the discharge of many types of substances along with wastewater, and large percentages of these substances enter the sewerage system. As a result, the sewage-treated effluent contains not only organic and toxic substances which are controlled by wastewater regulations, but also various pathogenic microorganisms, trace toxic substances, and endocrine disrupting chemicals. Outbreaks of infectious diseases and accidental spill and discharge of pollutants in sewerage areas may cause serious injury to human health through the water cycle system from wastewater to water supply. A mass infection by *Cryptosporidium* of about 8.8 thousand inhabitants occurred at Ogose Town in Saitama Prefecture in June 1996, raising concerns about the circulation of water from wastewater, to river water, to drinking water, and back to wastewater. Many relatively large cities that have operated sewerage system for a long time adopt a combined sewer system, but the drainage of storm-water may affect water use in the areas where water is discharged. Surveys to assess the actual state of the influence have just begun.

The discharge of sewage-treated effluent into source areas of municipal water supply is a critical problem particularly in a water basin containing intricate intake and discharge systems, as seen in the case of the Yodo River, (Fig. 8). Even without unexpected problems such as accidents, when the flow of river water reduces during drought, the percentage of sewage-treated effluent in river water increases, thus increasing the risk accordingly. The percentage of sewage-treated effluent in river water at Hirakata Ohashi Bridge, which is in the lower reaches of the Yodo River, is around 5% under normal conditions, and increased to almost 25% during the drought in 1994 (Fig. 9).

Consequently, to control the risks in the water system particularly in an emergency, the basin-wide approach is required. Nevertheless, the Comprehensive Basin-wide Planning of Sewerage Systems cannot handle this problem; this issue remains to be solved.

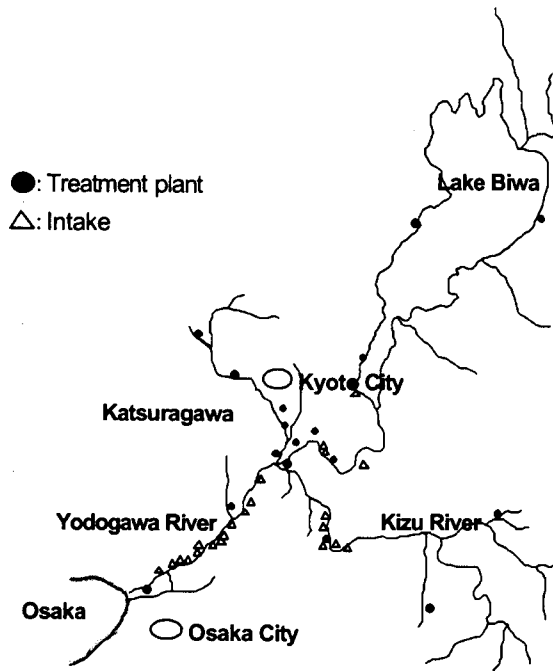

Fig.8 Intake/drainage system along Lake Biwa and the Yodo River

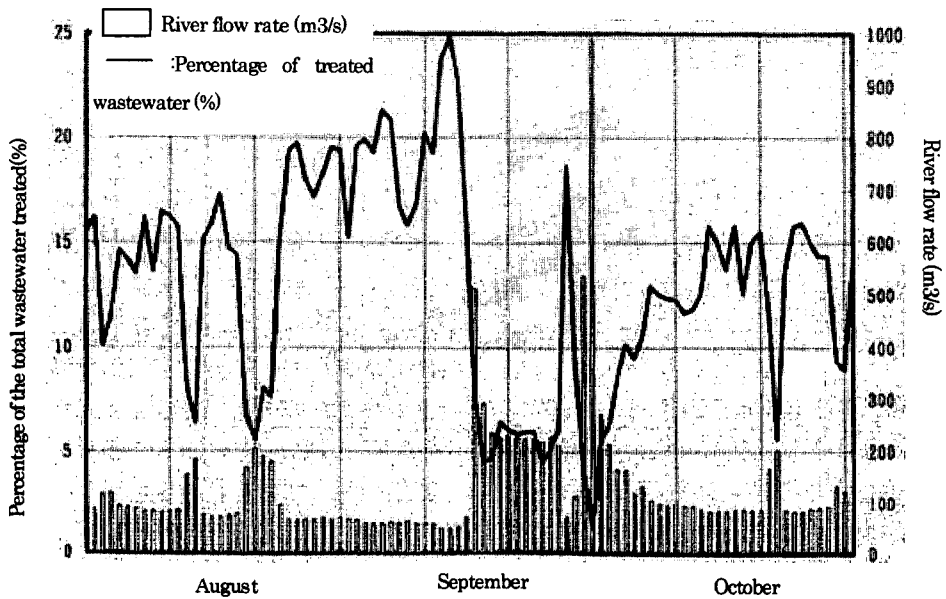

Fig.9 Daily variation in the percentage of treated wastewater in the flow of the Yodo River (August – October 1994)

6. Legal Systems on Sewage Works

6-1 Responsibility for connection, charges and control of discharges from industrial facilities

Japan has various legal systems governing sewerage to ensure that the projected benefits are attained, and to contribute to the living environment and conservation of water quality.

The household pays the cost of constructing house connection facilities from where sewage is discharged from individual houses to where it enters a sewer, because the section lies within the area of the house and the property belongs to the household. Because sewerage is basic urban infrastructure to play the public role in such areas as public health including prevention of infectious diseases, prevention of disasters caused by flooding, conservation of water quality in the public water body, and because these objectives should not be sufficiently achieved if we left it to individuals whether to use it or not, the Sewerage Law specifies that households and commercial bodies have a “responsibility to connect” to a sewer within three years after the completion of sewerage. And it is also stipulated that, as in the case of tax, user charge should be set and collected by the administrator, i.e., local governments, according to tariff system based on ordinance. Wastewater discharged from commercial or industrial facilities often contains high concentrations of various hazardous substances. If such wastewater enters a treatment facility, biological treatment at the facility may be damaged and the treated water may fail to satisfy the legal limits for water quality. The Sewerage Law therefore specifies a “discharge standard” for limiting the inflow of wastewater of a quality outside the scope of treatment by the facility and for adequately controlling the effluent water quality. Through these legal frameworks, official powers are given to the sewerage manager to ensure that sewerage works projects function effectively.

6-2 Work-sharing among national government, prefectures and municipalities ; public expenses for storm-water management and users expenses for sanitary wastewater treatment ; and what about advanced treatment?

In Japan, the relevant local public bodies conduct the construction, operation, and renewal of sewerage facilities. However, sewerage facilities in Japan also serve to drain storm-water and conserve the water quality in public water bodies. As a single public body has limited ability to plan and to fund projects covering all these, the national and local governments broadly share the work. Examples include a specification of the Sewerage Law that requests approval of the ministers concerned or of the prefectural governor for executing sewerage works of municipalities, and national subsidies are given to the construction project of major facilities of sewerage.

Regarding financial resources, in principle the discharger is responsible for treating wastewater, that is, the beneficiary must pay the cost: the charge and benefit principal expenses. On the other hand, the cost of draining stormwater is paid by the local municipality similar to the cost of flood control, in other words, is paid from taxes. Taking into account the objective of sewerage works projects, the national policy that people should receive equal sewerage services, the fact that the construction of sewerage

system requires a large investment which is a major burden on the local public body concerned, and that the sewerage system has external economic impacts on other industrial and social fields, the government and local public bodies pay a certain proportion of the necessary expenses.

As for advanced treatment, the expenses might be paid by the private firms or inhabitants who are responsible for the treatment at the ultimate stage based on the polluter-pays principle (PPP) under the strengthened water quality regulation. However, for advanced treatment conducted earlier than that by other firms or local public bodies, local governments have to pay the expenses for themselves from the viewpoint of ensuring an equal burden, the responsibility to discharge and the beneficiary, and the capacity to pay the cost. It is pointed out that some kind of meetings should be organized to discuss the burden sharing among major dischargers in each basin.

7. Issues in the Public-Private Partnership

7-1 Guideline of entrusting to private sector

Japanese law specifies that the local public bodies are basically responsible for public sewerage works. Nevertheless, considering the severe financial situation of local public bodies and the trends of future maintenance works, some of the maintenance work which does not involve official authority may well be entrusted to private contractors. (Fig.10)

Conduit		(as of the end of 2000) Unit: %		
Conduit	Cleaning	80.8*	10.8	8.4***
	Survey	71.0	14.6	14.4
	Repair	80.7	8.8	10.5
Wastewater treatment plant		(as of the end of 2000) Unit: %		
Operation and maintenance	Pumps	78.5	8.0	13.5
	Water treatment	78.3	8.2	13.5
	Sludge treatment	84.2	8.0	7.8
Curve yards	Grit	91.5	2.5	6.0
	Sludge	95.4	1.8	2.8
Cleaning, etc.	Control building	77.9	12.9	9.2
	Care-taking of greens	72.2	17.5	10.3
Water quality and sludge analyses		62.4	31.3	6.3
Checking and Maintenance	Boilers	88.9	6.9	4.2
	Air conditioning	82.5	3.9	8.6
	Fire control	81.1	16.9	2.0
	Instrumentation	81.8	14.4	3.8
	machinery	77.6	16.0	6.4

Note: (*) Totally commissioned, (**) Partially commissioned, (***) Directly managed

Fig.10 Utilization of Private Businesses

Currently, around 90% of the local public bodies entrust the work of operating and maintaining treatment facilities, which accounts for much of the maintenance cost of sewerage facilities, to private contractors. Most of the transferred works are conducted under a single-year contract with a specification preliminarily determined. The Ministry of Land, Infrastructure and Transport issued the "Guideline for entrusting operation and maintenance works to private sectors based on the performance requirement and evaluation" in 2001 to encourage the entrusting of sewage works to private contractors, in the expectation of lower cost and increased efficiency. The guideline recommends the concept of "performance requirement and evaluation" in the contract agreement, which had not previously been adopted.

7-2 Making sewage works more efficient by properly utilizing the private sector's vitality

In order to introduce smoothly the entrusting of operation and maintenance works to private sectors based on the performance requirement and evaluation, it is necessary to have criteria and know-how for the evaluation and monitoring of services, techniques and performances of private enterprises. In other words, local governments should be equipped with ability to select appropriate private enterprises, the know-how for transfer-related contracts, ability to evaluate the performance of private contractors, and ability to monitor for preventing moral hazards of the contractors. Small and medium-sized municipalities, which do not have sufficient capabilities of sewage works, demand the supports from an appropriate independent institution.

8. The 3rd World Water Forum

The 3rd World Water Forum will be held at Kyoto, Shiga, and Osaka, which are in the river basin of Yodo River and Biwa Lake, from March 16 to 23, 2003. A ministerial international session will be held at the same time, led by the Japanese government, at Kyoto on March 22 and 23, 2003, at which ministers in charge of water issues in many countries will discuss a variety of water issues. We hope that the 3rd World Water Forum will be a great success in contributing to the solution of water-related problems worldwide.

In preparation for the Forum, Japan Sewerage Committee for the 3rd World Water Forum was set up, consisting of academic specialists and the staff of industries and governments, led by Tomonori Matsuo, Professor of Toyo University, as the chairman. The Committee will hold a workshop on wastewater treatment and water pollution control in the Forum.

"Wastewater Management and Sanitation" (URL <http://www.worldwaterforum.org/for/en/fshow.218>) in the virtual forum chaired by Dr. Fukui, President of Japan Sewage Works Association has already contributed greatly to international discussions, case studies on the effect of sewage works, the financing of sewerage system, and other subjects. The secretariat of the 3rd World Water Forum

gave the highest score to the above virtual forum in March, and the second highest in July.

The Committee held the “Workshop on Wastewater Management and Public-Private Partnership” toward the 3rd World Water Forum in Nagoya on July 26. At the workshop, reports on the current state of the sewerage system in Korea, Malaysia, Germany, France, and Japan were presented, and panel discussions were held on wastewater management and partnerships between the public and private sectors. A declaration was adopted at the end of the workshop. The Committee plans to hold a large session at the 3rd World Water Forum on the subject of “Wastewater Management and Water Pollution Control”.

3. Overview of Drinking Water Quality Management And Wastewater Control

Presenter

Mrs.Sally C. Gutierrez, USEPA



U. S. Drinking Water Quality Management and Wastewater Control Current Research Issues

Japan – U.S. Governmental Conference on
Water Quality Management and Wastewater
Control

Tokyo, Japan
October 21, 2002



Overview

- Background
- Current & Future Drinking Water Research Priorities
- Homeland Security
- Current & Future Wastewater & Water Quality Research Priorities
- Summary

BACKGROUND

U.S. EPA Organizational Structure

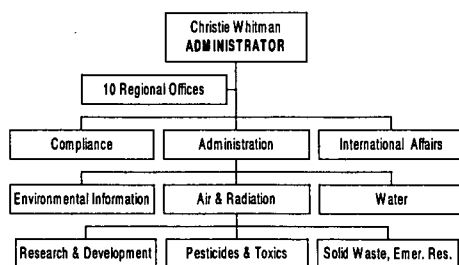

Office of Research and Development

ORGANIZED ACCORDING TO THE
RISK PARADIGM

- Risk Assessment
- Risk Management
- Risk Communication

Office of Research and Development

- National Health and Environmental Exposure Research Laboratory
- National Exposure Research Laboratory
- National Risk Management Research Laboratory
- National Center for Environmental Assessment
- National Center for Environmental Research
- National Center for Homeland Security - NEW

National Risk Management Research Laboratory

- Focused research on technologies and approaches to remove and control contaminants regulated or contemplated for regulation by the Agency.
- Covers all media
 - Air
 - Water
 - Waste

Water Supply and Water Resources Division

- Primary mission is to provide treatment and control information for drinking water contaminants regulated or considered for regulation by the Office of Ground Water & Drinking Water
- Also responsible for leading watershed management research program for the Laboratory including urban wet weather flow

Water Supply and Water Resources Division

- Problem-focused
- Applied
- Largely in-house
- Is performed at bench, pilot and full-scale

Research Emphasis over the Last 10 Years

Research Focus 1990-2000

- Control of *Cryptosporidium* and *Giardia*
- Arsenic
- Control of Disinfection By-Products

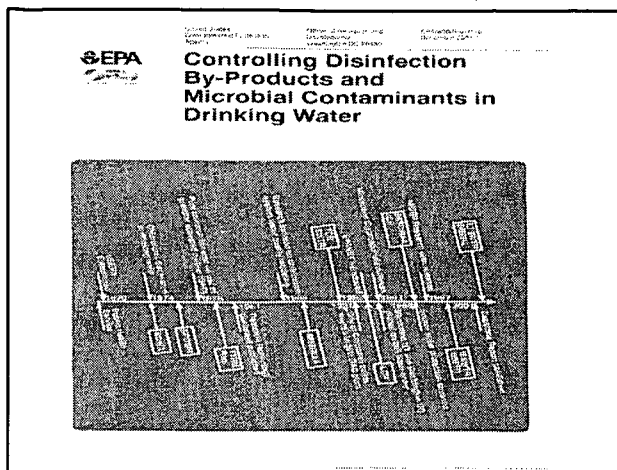

Current and Future Drinking Water Research Priorities

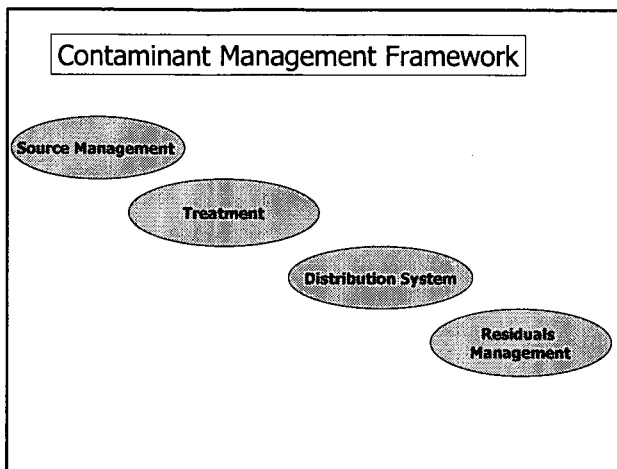

- ### Major Research Themes
- Contaminant Candidate List (chemical and microbial)
 - Implementation/Revision of M/DBP Rule
 - Implementation/Revision of Arsenic Rule
 - Distribution System

- ### Major Research Themes
- Source Water Protection
 - Six -Year Review
 - Emerging Issues

- ### Future Research Priorities
- Contaminant screening
 - Holistic treatment approaches – rather than contaminant-by-contaminant
 - Infrastructure – develop cost effective ways to extend life/preserve/monitor condition
 - Monitoring approaches – amount and quality of data allows for better management

Microbial Contaminants Research

Microarrays

- An array of genetic probes can be prepared that will allow an environmental sample to be simultaneously probed for many types of microbes, including pathogens, indicator organisms and specific gene sequences such as toxin genes.
- Microarrays are a powerful tool that will provide a wealth of new information.

Microbial Genetic Response to Ecosystem Stress

Control +++ Ammonia

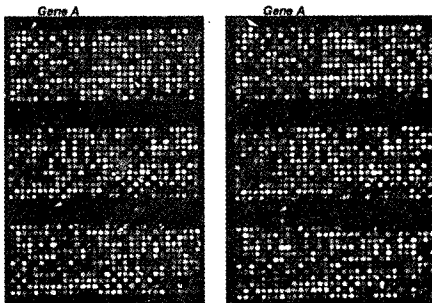

Water System Security



Homeland Security

- Following 9/11/2001, the Centers for Disease Control and Prevention requested EPA collaboration on disinfection studies of surrogate organisms for specific agents
- Collaborating by conducting disinfection studies on the surrogates for the agents (bacteria only)

Homeland Security

Priority given to work on surrogate for *Bacillus anthracis* because the information is needed advise water systems and consumers on what to do to respond in the event of water system contamination with this organism.

Bacillus anthracis

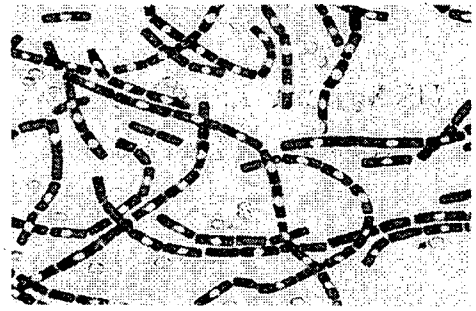

Kenneth Todar, Univ. of Wisconsin - Madison

Bioterrorism Agent Surrogate Research

<u>BT Agent</u>	<u>Surrogate</u>
<i>Bacillus anthracis</i>	<i>Bacillus cereus</i>
“ “	<i>Bacillus thuringiensis</i>
“ “	<i>Bacillus globigii</i>

Water Quality Research Priorities

Water Quality Research Emphasis

- Watershed Approach
- Total Maximum Daily Loads
- Management of residuals such as biosolids, animal manure

Watershed Approach

US Water Quality Problems Becoming Very Complex

Watershed Approach

- Water Quality Management can best be accomplished by looking at entire drainage area
- Important to look at all potential sources of pollution within drainage area, holistically, point and non-point
- Can begin to integrate water quality and drinking water protection efforts

Case Study

Background

- Hoover Reservoir is central Ohio's largest source of drinking water providing water to 580,000 people in the Columbus area
- The Upper Big Walnut Creek watershed encompasses nearly 190 square miles of predominantly agricultural cropland that drains into Hoover Reservoir
- Infrequent occurrences of elevated Atrazine levels (4-12 mg/L) detected at treatment plant (MCL = 3 mg/L)

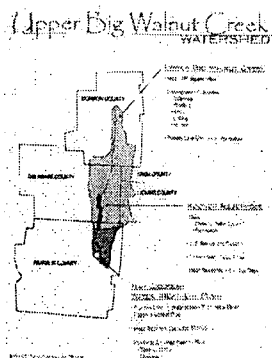

Background

- Downstream Atrazine Management
 - City of Columbus has spent \$2 million for Powdered Activated Carbon (PAC) since 1997
 - Might have to install GAC
- Watershed Atrazine Management
 - City of Columbus and agricultural community developed a collaborative partnership to help reduce runoff
 - BMPs implemented on 23,000 acres at a cost of nearly a million dollars
 - Atrazine levels still elevated

Project Objectives

- Develop a methodology to determine the cost and effectiveness of non-point BMPs
- Qualify “cause and effect” relationships between land management and water quality

Results

- Preliminary modeling indicates that antecedent soil moisture content, timing of Atrazine application, and soil water holding capabilities seem to be more critical than total amount of atrazine applied

Total Maximum Daily Loads

Total Maximum Daily Loads

- Federal Clean Water Act requirement applied to water bodies that are reported by State/tribe to exceed their established water quality standards
- Once provision applies, a TMDL is required that apportions the amount of a pollutant that must be reduced in order to bring the water body back to its designated standard

Current and Future Research Issues

- Monitoring and Assessment Methods – biological endpoints increasingly used to determine health of waterbody
- Modeling/Decision Support/Cost
- Restoration methods on a watershed scale

Biosolids and Animal Waste

- Disposal of these waste materials are cause of concern among the public
- Amount of material has increased over the last 10 years
- Water quality problems related to these materials need to be addressed

Research Issues

- What does the material contain and how do we measure it – nutrients, pathogens, endocrine disrupting chemicals, pharmaceuticals
- What is appropriate application/ management of the material on land areas
- What are the human and ecological effects associated with these materials if they are released into the environment

Summary

- US developing methods to integrate drinking water and water quality related programs
- New tools hold promise to assist in making programs more effective
- Water System Security increasing in emphasis
- Remaining water quality problems in US will be more difficult to resolve than previous 20-30 years

Thank you for your attention



4. Current and Future Regulatory Activities in Japan

Presenter

Mr. Kazumi KISHIBE, Ministry of Health, Labour and Welfare

Current and Future Regulatory Activities in Japan

Japan/US Governmental Conference on
Drinking Water Quality Management and Wastewater control
Tokyo, Japan
21-23 October 2002

Kazumi KISHIBE
Director, Office of Drinking Water Quality Management
Ministry of Health, Labour and Welfare

Abstract

Almost ten years have passed since the comprehensive revision of the drinking water quality standards took place. In this period, several issues to be dealt with have emerged or been elaborated, for example bromate production in ozonization process, *Cryptosporidium* infection, contamination of endocrine disruptors.

With this as a background, the Ministry of Health, Labour and Welfare has decided to fully revise the drinking water quality standards as well as to consider the effective system to cope with such problems. It plans to establish new drinking water quality standards and management system next year.

1. Drinking water quality standards (DWQSSs)

Drinking water quality standards (DWQSSs) make a basis of drinking water quality management. The Water Works Law prescribes them in the article 4, saying that water that is provided by water supply system shall comply with the DWQSSs. The DWQSSs shall be set from the viewpoints of both protecting human health and assuring good quality of life, and elaborated by the Ministry's order.

Once the DWQSSs have been set, every water supplier shall take necessary measures to ensure them under the provisions of the Law, for example:

- a. Necessary facilities shall be furnished and well be operated;
- b. A person in charge of technical issues shall be designated;
- c. Water quality shall be monitored on a periodical and an *ad hoc* basis;
- d. Treatment plant workers shall have health check periodically; and,
- e. Chlorination process shall be included in every treatment plant.

When incompliance with the DWQSSs is found, water supplier shall review its system and improve it as soon as possible. In case of emergency, such as the case where pathogens are detected or suspected in purified water, water supplier shall stop supplying their water to consumers immediately.

Up to now, the DWQSSs have been set for 46 items, 29 for protection of human health and 17 for good quality of life. (Table 1)

In addition to the DWQSSs, the Ministry has set three kinds of guidelines and been calling for voluntary monitoring and compliance; guidelines for chemicals of priority, pesticides used in golf courses and comfortableness. They are shown in the Table 2,3 and 4, respectively.

2. Revision of the DWQSSs

Since 1992, when the current DWQSSs were set, it has been recognized clear that they could not cover new pollutants, for bromate in ozonization process, infection by chlorine-resistant pathogens, endocrine disruptors. In addition, the WHO has started to revise its Guidelines for drinking-water quality (GDWQs). The Ministry has decided to revise DWQSSs as well as to improve drinking water quality management system, taking these situations into consideration.

In July 2002, the Ministry of Health, Labour and Welfare has established the advisory committee for the drinking water quality management chaired by Prof. Magara. The mandate of the committee is to review scientific and technological aspects on drinking water quality and to recommend the Ministry the revised DWQSSs as well as improved drinking water quality management system. While the discussion of the committee has not been concluded, the main points are follows.

2.1 Flexible Application of the DWQSSs

Current DWQSSs are applied uniformly to all water works, while drinking water quality is varied by region, type and quality of source water as well as type of treatment method. Although this system has greatly contributed to the improvement of the drinking water quality in Japan, some problems, such as that chemicals of local concern could not be included in the DWQSSs, are pointed out. The committee is reviewing the advantage and disadvantage of the current system, and considering the way to attach the flexibility to it.

2.2 Rolling revision of the DWQSSs

In line with the coming WHO/GDWQs third edition, the committee is considering how rolling revision could be incorporated into Japanese system.

2.3 Good practice for assuring safe drinking water

As real-time monitoring of all contaminants is impossible, it is important to assess in advance the risk of pollution including the risk of incompliance with the DWQSSs, and to take preventive measures. Such a concept is adopted in Hazard Analysis and Critical Control Point (HACCP) for food sanitation and Water Safety Plan of the WHO. The committee is discussing how to incorporate this concept into drinking water quality management.

2.4 Biological aspects of the DWQSSs

2.4.1 Total coliforms and standard plate count

As indicators of fecal pollution, total coliforms and standard plate count are adopted in the DWQSSs. The committee is reassessing these parameters, focusing on whether to adopt *Escherichia coli* and/or Heterotrophic plate count (HPC) instead of them.

2.4.2 Chlorine-resistant pathogens

One of the greatest concerns in the field of drinking water quality management is how to deal with chlorine-resistant pathogens such as *Cryptosporidium parvum*.

The Water Works Law prescribes in the article 5 that water supplier shall establish filtration facility when it finds the risk of contamination of chlorine-resistant pathogens. The Ministry has set the guideline for chlorine-resistant pathogens at October 1996 (revised at October 2001), which shows the way of assessing the risk of pollution and preventive measures and emergency operations to be taken by water supplier.

Besides, infection by *C. parvum* has been sometimes reported. The committee is considering effective measures including the introduction of new regulation.

2.4.3 Pathogens in distribution system and water tanks

Regrowth of pathogens such as *Legionella* in distribution system and water tanks is also of concern. The committee is considering introducing the HPC as an indicator of such pathogens.

2.5 Chemical aspects of the DWQSSs

2.5.1 Disinfectant by-product

Trihalogenated methanes were main points of discussion at the previous revision of the DWQSSs in terms of disinfectant by-product. Through various efforts, the level of trihalogenated methanes in drinking water has dramatically reduced.

Instead, we are facing other contaminants: bromates and halogenated acetic acids. As ozonization process is widely adopted in treatment plants, bromates contamination became a problem of concern. The reduction of trihalogenated methanes made it clear that we should deal with halogenated acetic acids accordingly.

The committee is considering setting the DWQSSs for these contaminants.

2.5.2 Endocrine disruptors

Endocrine disruptors have attracted global concern, however, it is not established yet how to estimate their effects, including so called low dose effects. Therefore, the committee is considering carefully how to deal with them.

2.5.3 Pesticides

Pesticides have quite different character from other chemicals in terms of their usage. Contamination of pesticides is limited as it depends on the area and period of application. However, pesticides in drinking water are of high interest. The committee is considering how to deal with them, taking into account such situation.

2.5.4 Lead

Prior to the establishment of the committee, the Ministry decided to reduce the DWQS for lead to 0.01 mg/l from 0.05 mg/l, taking into account the recommendation in 1992 made by the former advisory committee to do so in ten years. New DWQS for lead will be effective on 1 April 2003.

2.6 Quality assurance/Quality control (QA/QC)

It is needless to say that Quality assurance and control (QA/QC) of drinking water quality monitoring is very much important. Although there exists QA/QC system, it should be refined taking into account the progress made since the last revision.

The committee is reviewing QA/QC system in other fields as well as international standard such as ISO 17025, and considering the new QA/QC system in the field of drinking water quality monitoring. The discussion will be focused on the clear incorporation of Good Laboratory Practice concept, which is not familiar in Japan.

2.7 Sampling/Evaluation

The committee is reviewing the current sampling/evaluation procedures and considering renewing it, taking into full account the methods/procedures of the US, EU and WHO.

3. Conclusion

The coming revision of the DWQSs in 2003 will be the first comprehensive revision since 1992. It will substantially enhance them in both the concept and the coverage of pollutants.

Safe drinking water is vital for our life, and the stress should be focused on drinking water quality management in managing the water supply system. We are sure that the new DWQSs will greatly contribute to improve our system of drinking water quality management.

Table 1 Drinking Water Quality Standards (DWQSS)

(For protection of human health)

No	Item	Standard Value	No	Item	Standard Value
1	Standard Plate Count	100 in 1ml	16	<i>cis</i> -1,2,-Dichloroethylene	0.04mg/l
2	Coliform Group Bacterial Count	Not to be detected	17	Tetrachloroethylene	0.01mg/l
3	Cadmium	0.01mg/l	18	1,1,2-Trichloroethane	0.006mg/l
4	Mercury	0.0005mg/l	19	Trichloroethylene	0.03mg/l
5	Selenium	0.01mg/l	20	Benzene	0.01mg/l
6	Lead	0.01mg/l	21	Chloroform	0.06mg/l
7	Arsenic	0.01mg/l	22	Dibromochloromethane	0.1 mg/l
8	Chromium(VI)	0.05mg/l	23	Bromodichloromethane	0.03mg/l
9	Cyanide	0.01mg/l	24	Bromoform	0.09mg/l
10	Nitrates/Nitrites	10mg/l as nitrogen	25	Total Trihalomethanes	0.1mg/l
11	Fluoride	0.8mg/l	26	1,3-Dichloropropene	0.002mg/l
12	Carbon Tetrachloride	0.002mg/l	27	Simazine	0.003mg/l
13	1,2-dichloroethane	0.004mg/l	28	Thiram	0.006mg/l
14	1,1-Dichloroethylene	0.02mg/l	29	Thiobencarb	0.02mg/l
15	Dichloromethane	0.02mg/l			

(For good quality of life)

No	Item	Standard Value	No	Item	Standard Value
30	Zinc	1.0 mg/l	39	1,1,1-Trichloroethane	0.3mg/l
31	Iron	0.3mg/l	40	Phenols	0.005mg/l as phenol
32	Copper	1.0mg/l	41	Organic Substances (Consumption of Potassium Permanganate)	10mg/l
33	Sodium	200mg/l	42	pH Value	5.8 - 8.6
34	Manganese	0.05mg/l	43	Taste	Not abnormal
35	Chloride	200mg/l	44	Odor	Not abnormal
36	Calcium, Magnesium, etc. (Hardness)	300mg/l	45	Color	5 degree
37	Total Residue	500mg/l	46	Turbidity	2 degree
38	Methylene Blue Activated Substance	0.2mg/l			

Table 2 Guidelines for chemicals of priority

No	Item	Guideline value	No	Item	Guideline value
1	<i>trans</i> -1,2-Dichloroethylene	0.04mg/l	19	Chloral Hydrate *	0.03mg/l
2	Toluene	0.6mg/l	20	Isoxathion	0.008mg/l
3	Xylenes	0.4mg/l	21	Diazinon	0.005mg/l
4	<i>p</i> -Dichlorobenzene	0.3mg/l	22	Fenitrothion(MEP)	0.003mg/l
5	1,2-Dichloropropane *	0.06mg/l	23	Isoprothiolane	0.04mg/l
6	Di (2-Ethylhexyl) Phthalate	0.06mg/l	24	Chlorothalonil (TPN)	0.05mg/l
7	Nickel *	0.01mg/l	25	Propyzamide	0.05mg/l
8	Antimony *	0.002mg/l	26	Dichlorvos (DDVP)	0.008 mg/l
9	Boron	1mg/l	27	Fenobcarb (BPMC)	0.02mg/l
10	Molybdenum	0.07mg/l	28	Chlornitrofen (CNP)	0.0001mg/l
11	Uranium *	0.002mg/l	29	Iprobenfos (IBP)	0.08mg/l
12	Nitrites *	0.05mg/l as nitrogen	30	EPN	0.06mg/l
13	Chlorine Dioxide	0.6mg/l	31	Bentazone	0.2mg/l
14	Chlorite	0.6mg/l	32	Carbofuran	0.005mg/l
15	Formaldehyde *	0.08mg/l	33	2,4-dichloro-phenoxyacetic acid	0.03mg/l
16	Dichloroacetic Acid *	0.02mg/l	34	Trichlopyr	0.06mg/l
17	Trichloroacetic Acid *	0.3mg/l	35	Dioxins *	1pg-TEQ/l
18	Dichloroacetnitrile *	0.08mg/l			

(* provisional values)

Table 3 Guidelines for pesticides used in golf courses

No	Item	Guideline value
	(Insecticides)	
1	Isofenphos	0.001 mg/l
2	Chlorpyrifos	0.004 mg/l
3	Trichlorfon	0.03 mg/l
4	Pyridaphenthion	0.002 mg/l
5	Acephate	0.08 mg/l
	(Fungicides)	
6	Iprodione	0.3 mg/l
7	Etridiazole	0.004 mg/l
8	Oxine-copper	0.04 mg/l
9	Captan	0.3 mg/l
10	Chloroneb	0.05 mg/l
11	Tolclophos-methyl	0.08 mg/l
12	Flutolanil	0.2 mg/l
13	Pencycuron	0.04 mg/l
14	Mepronil	0.1mg/l
15	Metalaxyl	0.05 mg/l
	(Herbicides)	
16	Asulam	0.2 mg / L
17	Terbucarb	0.02 mg/l
18	Napropamide	0.03 mg/l
19	Butamifos	0.004 mg/l
20	Bensulide	0.1 mg/l
21	Pendimethalin	0.05 mg/l
22	Benefin	0.08 mg/l
23	Mecoprop	0.005 mg/l
24	Methyl-dymron	0.03 mg/l
25	Dithiopyr	0.008 mg/l
26	Pyributicarb	0.02 mg/l

Table 4 Guidelines for comfortableness (13 Items)

No	Item	Guideline value	No	Item	Guideline value
1	Manganese	0.01mg/l	7	Free Carbon Dioxide	20mg/l
2	Aluminum	0.2mg/l	8	Organic Substances (Consumption of Potassium Permanganate)	3mg/l
3	Chlorine	Not more than approximately 1mg/l	9	Calcium Magnesium, etc. (Hardness)	10-100mg/l
4	2-Methylisoborneol	Powdered Activated Carbon Treatment: 0.00002mg/l Granular Activated Carbon Treatment: 0.00001mg/l	10	Total Residue	30-200mg/l
5	Geosmin	Powdered Activated Carbon Treatment: 0.00002mg/l Granular Activated Carbon Treatment: 0.00001mg/l	11	Turbidity	1 degree at a tap 0.1 degree at the entrance of a distribution facilities
6	Odor Threshold (TON)	3	12	Langhelier's index (Corrosiveness)	Approximately -1 to 0
			13	pH Value	Approximately 7.5

5. United States Drinking Water Regulations

Presenter

Jennifer McLain, USEPA



United States Drinking Water Regulations

Japan - U.S. Governmental Conference on Drinking Water Quality Management and Wastewater Control

October 2002

Jennifer McLain
U.S. Environmental Protection Agency
Washington, D.C.

1

Background

The Problem -- A Range of Public Health Risks in Drinking Water

- > **Acute Health Risks** - effects from short term exposure
 - > Bacteria (e.g., *e.coli*)
 - > Viruses (e.g., Hepatitis-B)
 - > Protozoa (e.g., *Cryptosporidium*, *Giardia*)
 - > Chemicals (e.g., nitrate)
- > **Chronic Health Risks** - from long term exposure
 - > Chemicals: metals (e.g., arsenic) synthetic organics (e.g., pesticides), and volatile organics (e.g., benzene)
 - > Disinfectants and byproducts (e.g., chlorine, bromate)
 - > Radiation (e.g., radon)
- > **Risks Come From Multiple Sources**

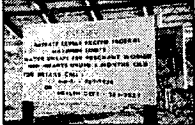
2

Background

The Solution: Multiple Barrier Approach to Public Health Protection

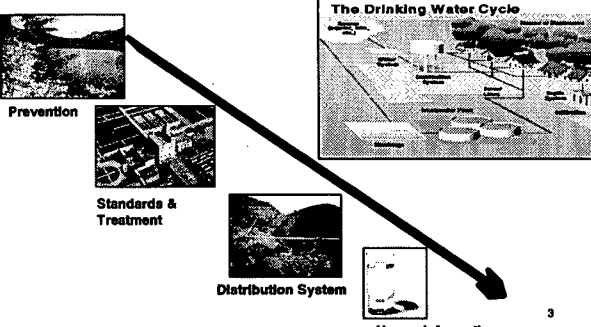

3

Standard Setting

Roles & Responsibilities

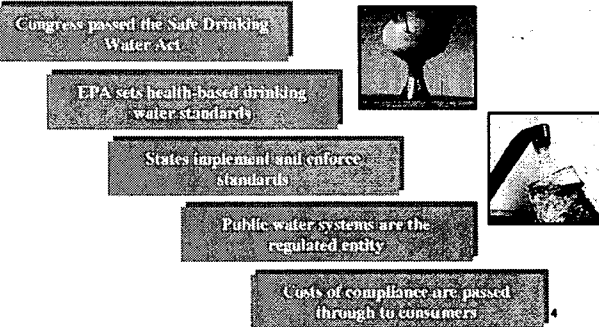

4

Background

Public Water Systems

- > **Non-Community Water Systems**
 - > Non Transient -- e.g., some schools, hospitals
 - > Transient -- e.g., highway rest stops, restaurants
- > **Community Water Systems (CWSs)**
 - > Serve year-round residents
 - > Serve 93% of the population
 - > Most of the population receives drinking water from large CWSs yet most water systems are small.

168,000 Public Water Systems

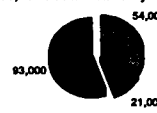

Population served by CWSs

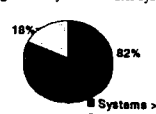

Size Distribution of CWSs

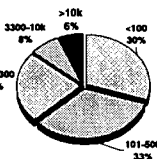

5

Background

SDWA 96: A New Approach to Reflect Changing Priorities (SDWA Section 1412)

SDWA Priority Contaminants

- Arsenic
- Radon
- Microbial/Disinfection byproducts
- Radionuclides

Contaminant Candidate Selection

Publish a list of drinking water contaminants every 5 years.

Decide whether to regulate at least 5 contaminants every 5 years

Final regulations within 3 1/2 years after determination



6 Year Review of Existing Regulations

Review and revise existing regulations every 5 years

Revisions shall maintain, or provide for greater protection of public health

6

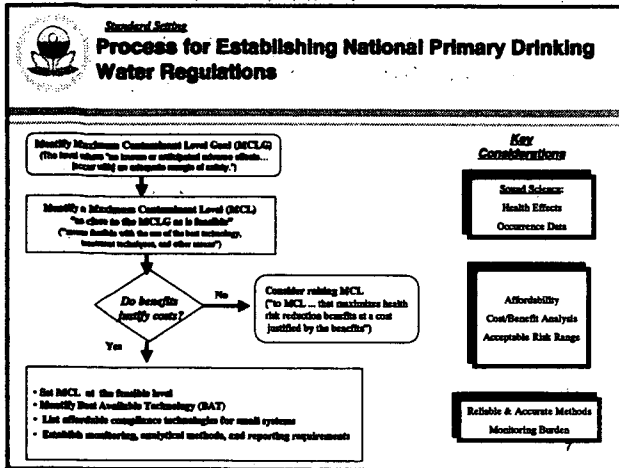

Standard Setting
Research and Data Collection to Support Sound Public Health Decisions

- Quality Information is Critical
 - Health Effects
 - Methods Development
 - Treatment Effectiveness Studies
 - Occurrence Data
- Overall Drinking Water Research
 - Comprehensive Drinking Water Research Strategy under development
 - Drinking Water Research Information Network (DRINK) - database of ongoing research
 - Completing necessary research requires partnership among a variety of institutions, countries and private organizations

8

Prevention
Contamination Prevention Programs

- Increased importance of prevention to supplement costly drinking water treatment
- Expanded emphasis on existing prevention programs
- 1996 SDWA source water assessment and prevention provisions
- Greater coordination and integration with other statutes & across Agencies

SDWA

Source Water Assessment & Protection
Underground Injection Control
Other (Wellhead Protection, Sole Source)

Coordination with Other Programs and Agencies

Programs: Clean Water Act programs, Hazardous Waste programs, Pesticides programs

Agencies: Department of the Interior, US Department of Agriculture

9

Prevention
Source Water Assessment & Protection Program (SDWA Section 1453)

- Goal: Protect Public Health by *Avoiding Contamination*
- Build on existing programs
- Flexibility to address local problems
- 173,000 assessments for all public water systems must be completed by States by 2003 followed by appropriate management measures
- Six Step Framework
 - Delineation
 - Source Inventory
 - Susceptibility Determination
 - Public Availability
 - Management Measures
 - Contingency Planning

10

Future Goals and Challenges

- Safe and affordable drinking water for all Americans
- Decisions based on sound science and risk
- Integrated water supply management
- Effective source water protection
- Well-managed and operated water systems
- Strong public information and outreach

11

FOR MORE INFORMATION

- WEBSITE: <http://www.epa.gov/safewater>
- EPA's Safe Drinking Water Hotline: 1-800-426-4791
- U.S. EPA - Office of Ground Water & Drinking Water: 202-564-3750

12

**6. Dioxins in water sources and its risk assessment of
drinking water**

Presenter

Yasmoto Magara, Hokkaido University

Dioxins in water sources and its risk assessment of drinking water

Yasmoto Magara, Hyun-koo Kim, Tasuku Kamei and Kohich Ohno

Abstract

PCDDs/DFs and Co-PCBs were monitored in raw and treated water of public water supply system in throughout Japan. In 40 water treatment plants for surface water and 5 for ground water, the removal efficiency of dioxins and the influence of chlorination in the several types of treatment processes were studied. Location of water treatment plant significantly not only influenced the concentration level of dioxins but also resulted in homologue patterns of dioxins.

This study showed that most of dioxins are well removed by conventional rapid sand filtration (CRSF) system, though powdered activated carbon (PAC) is much more effective to remove dioxins in water treatment process. However, in some water treatment plants, the level of TeCDFs (pg-WHO-TEQ/L) increased as the result of chlorination.

Origin of dioxins in raw water was estimated by multivariate statistical methods. In raw water, it was estimated that the most of dioxins and dioxin like compounds originates from pesticide such as pentachlorophenol (PCP) and 1,3,5-trichloro-2-(4-nitrophenoxy) benzene (CNP) that had been restricted their uses because of carcinogenic effect at least some years ago.

Key words —dioxins, water treatment, drinking water, pesticides run off

1. Introduction

Polychlorinated dibenzo-p-dioxins (PCDDs), dibenzofurans (PCDFs) and coplanar polychlorinated biphenyls (Co-PCBs) are distributed worldwide. Dioxins, furans and Co-PCBs are formed as unwanted byproducts in various chemical formulations and combustion process. These compounds enter the aquatic environment from the atmosphere and agricultural chemicals and as direct discharges from industrial sources, sewage treatment plants

Polychlorinated dibenzo-p-dioxins (PCDDs), dibenzofurans (PCDFs) and Co-PCBs are two classes of compounds that contain some of the most toxic chemical substances that are known. Some of these compounds are also regarded as potential human carcinogens. In addition, these compounds may accumulate in the food chain. For these reasons their presence in the environment is of concern. Fortunately, with the help of scientific analytical methods and instrumentation improvement, we were able to detect these compounds at lower concentrations especially in drinking water. This enabled us to find that these compounds appear to be ubiquitous in the environment. However, the U.S. EPA has set a maximum allowable value for

Department of Urban Environmental Engineering, Graduate School of Engineering, Hokkaido University, Kita-13, Nishi-8, Kita-ku, Sapporo, Hokkaido, 060-8628, Japan

2,3,7,8-tetraCDD in drinking water as low as 0.13 to 0.0013pg/L based on estimated human cancer risks at 10^{-5} to 10^{-7} , respectively, the true risk of these contaminants is still not well understood.

Based on the above backgrounds, this study has focused on the followings.

To find out the levels of PCDDs/Fs and Co-PCBs before and after water treatment at water treatment plant.

To identify the contribution of particulates dioxin to total dioxin levels in raw water.

To identify the behavior of dioxins in four types of water treatment system such as chlorination (process only for ground water), CRSF, PAC adsorption followed by CRSF and CRSF followed by ozonation / biological activated carbon adsorption (O_3/BAC).

To identify the origin attribution of dioxins in raw water

2. Materials and Methods

2.1 Sample collection

As shown in Fig 1., raw and treated water samples were collected at 45 water treatment plants in Japan. Water sources for 40 water treatment plants and five water treatment plants were surface water and ground waters, respectively. Each water plant was sampled twice, July and November in 1999. 200L for raw water and 2000L for treated water were collected, respectively.

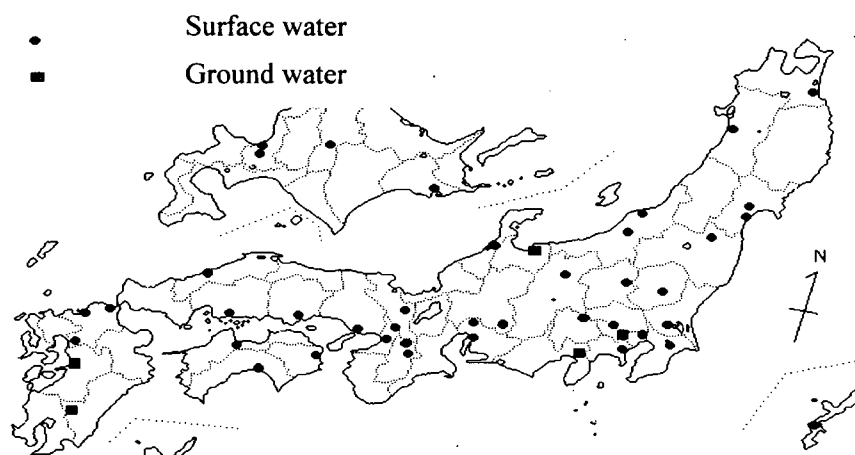

Fig. 1. Sites for the collection of water samples in Japan

Automatic “*in situ*” pre-concentration system was used for sampling 200L for raw water and 2000L for treated water, respectively (Magara et al. 1999). This system is fabricated by electrolyze-mirror polish treated stainless steel, air removal chamber, a glass fiber filter (GFF, 300mm ID, 0.5um pore size) holder, polyurethane form plug (PUFP, 100mm ID, 100mm height) holders, valves and sensors with an external computer controller.

2.2 Analysis

For analysis and detection of PCDDs/PCDFs and Co-PCBs a high-resolution gas chromatograph (HRGC, Hewlett Packard6890), coupled to a high-resolution mass spectrometer (HRMS, Auto-Spec, Micromass) was used after soxhlet extraction and gel clean-up procedures. The TEF value established by WHO in 1997 was applied to the above compounds for TEQ value.

GFF and PUFP were dried in a desiccator. After spiking with internal standard ^{13}C compounds, PCDDs/PCDFs and Co-PCBs were extracted by methylene chloride for 24hrs, GFF

using toluene for 24hrs with a soxhlet extractor. Multi layer silica gel and activated carbon column chromatographies were employed for sample clean up. Concentration of PCDDs/PCDFs and Co-PCBs was determined by use of isotope dilution HRGC (6890, Hewlett Packard, US)/HRMS (Auto-Spec, Micromass, UK). Seventeen native and ^{13}C 2,3,7,8-substituted dioxin/furan isomers (Wellington Laboratories, Canada) and twelve native (IUPAC #77, #81, #126, #169, #105, #114, #118, #123, #156, #157, #167 and #189; AccuStandard, USA) and ^{13}C (Wellington Laboratories, Canada) Co-PCBs were used as internal and isotope spike standards.

Organic solvents used for analysis were purified by non-boiling distillations. Glassware, GFF and SUS were heated to 300°C after applying an organic solvent wash. PUFs were pre-washed by soxhlet reflux with methylene chloride for longer than 24hrs after a purified water and acetone wash. All procedures were carried out in a clean room (class < 10,000).

BPX-5 (60m length, 0.25mm ID, 0.25 μm film thickness, SGE, Australia) for TeCDDs-OCDD, TeCDFs-OCDF, Co-PCBs and BPX-50 (60m length, 0.25mm ID, 0.25 μm film thickness, SGE, Australia) for PeCDFs, HxCDFs are equipped for HRGC to reduce the chemical background from liquid phase. Residual blanks were analyzed to check for interference or contamination arising from solvents or glassware.

3. Results and Discussion

3.1 Dioxins level before water treatment at water treatment plant

Histograms of measured concentration (pg/L) and toxic equivalent (pg-TEQ/L) for 90 raw water samples are shown in Fig. 2 and Fig.3. The survey found that 76 samples had concentrations below 100pg/L and 12 samples had values 100~300pg/L. The highest concentration found in one sample was 540pg/L. In terms of TEQ shown in Figure 3, level of TEQ at 11 sampling sites were below 0.01 pg-TEQ/L, level of TEQ of 46 sampling sites ranged from 0.01 to 0.1pg-TEQ/L. At 29 sampling sites and 4sampling sites, concentration ranged from 0.1~0.5pg-TEQ/L and 0.5~1.0pg-TEQ/L, respectively.

As expected, the portion of ground water to total average concentration was slight; 3.48pg/L (6.2% to total dioxins) whereas the concentration of surface water was much higher; 63.07pg/L. The average concentration of ground water is about 4 times lower than that of 25 sampling sites in Japan. The average concentration of surface water is similar to the results by the Japanese Environment Agency (Japanese Environmental Agency, 1998) and lower than that in Germany and England (Gotz et al., 1994; Rose et al., 1994).

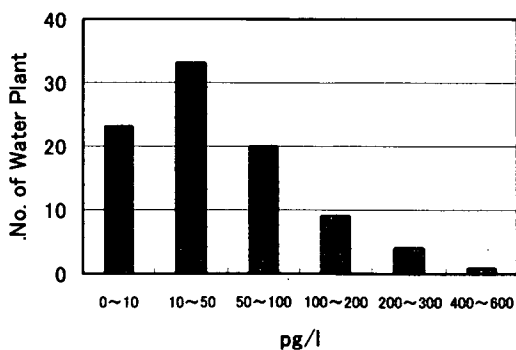

Fig. 2. Distribution dioxins in of raw water as pg/l

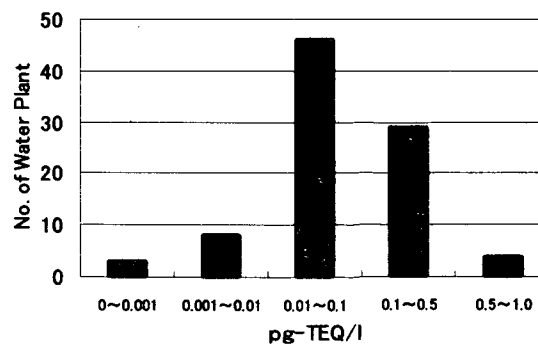

Fig. 3. Distribution of dioxins in raw water as pg-TEQ/L

As for the congener distribution of the total concentration of surface and ground water, total PCDDs were 45.33pg/L (70.0%) and 0.0076pg-TEQ/L (51.2%). Total PCDFs was

4.23pg/L (7.5%) and 0.0063pg-TEQ/L (42.4%). Total Co-PCBs was 12.71pg/L (22.5%) and 0.0094pg-TEQ/L (6.4%). The contribution of distribution varies depending on the types of "unit" used (pg/L or pg-TEQ/L). In terms of pg/L total PCDFs account for 7.5% of the total dioxins, whereas in terms of pg-TEQ/L account for 42.4% of total dioxins. OCDD (42.1%) and mono-ortho PCBs (20.9%) were predominant in terms of pg/L however, in terms of pg-TEQ/L the ratio of these homologues to total dioxins reduced from 42.1% to 1.6% for OCDD and 20.9% to 1.1% for mono-ortho PCBs.

In ground water, as the substituted number of chlorine increases from tetra to octa the concentrations of congeners decreased except OCDD. This result clearly indicates the relationship between the amount of chlorine in dioxins and the solubility of congeners in water. That is, the solubility of TeCDDs/DFs is 1,000 ~10,000 times higher than that of OCDD/DF. As regards the isomeric patterns, 1,3,6,8-TeCDD, 1,3,7,9-TeCDD, 2,4,6,8-TeCDF, 1,2,4,6,8,9-HxCDF, 1,2,3,4,6,7,9-HpCDD, OCDD and OCDF were the specific isomers in raw water. These isomers are present in herbicides such as CNP and PCP, which are ubiquitous in agricultural areas (Hagenmaier H. et al., 1987; Masunaga S., 1999).

3.2 Dioxins level after water treatment at water treatment plant

As we discussed in Fig. 2 and Fig. 3, concentration of total dioxins in treated water was one tenth as low as that of the raw water in pg/L value (Fig. 4). Dioxins levels for most of treated waters were below 0.1pg-TEQ/L (Fig. 5). However, dioxins were detected in two surface waters with concentrations ranging from 0.5 to 1.0 pg-TEQ/L. This concentration level is almost equal to the current maximum allowable dioxins level of 1 pg-TEQ/L (Japanese Environmental Agency, 1999).

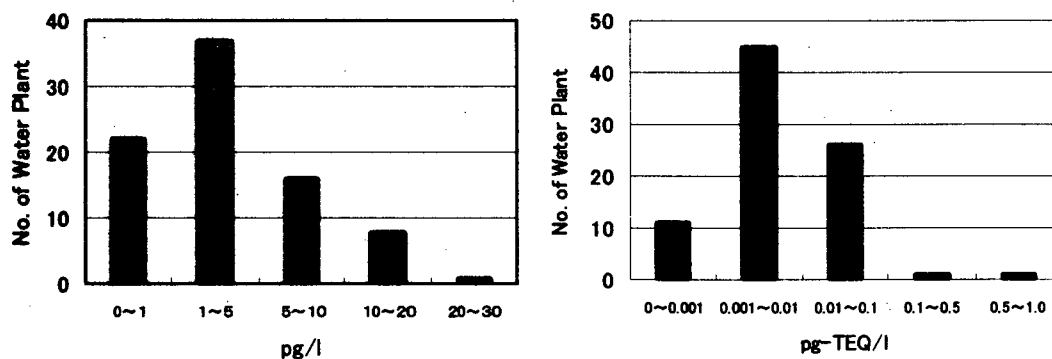

Fig. 4. Distribution of treated water PCDDs/DFs and Co-PCBs concentration as pg/L Fig. 5. Distribution of treated water CDDs/DFs and Co-PCBs concentration as pg-TEQ/L

The concentrations of PCDDs/DFs and Co-PCBs of ground water after treatment was approximately 1/10 of the level determined for the surface water after treatment. This is close to the TEQ concentration levels found earlier in Japan (Miyata H., et al., 1993) but approximately 1/4 of the level determined for the sample in Canada (Birmingham M. et al., 1989).

The percentage of OCDD (42.1% as pg/L) to total dioxins in raw water decreased to 3.7% after water treatment. On the other hand, the percentage (pg/L base) of mono-ortho PCBs (20.9%), TeCDDs (17.4%), and TeCDFs (2.0%) in raw water increased drastically to 47.1%, 28.0% and 10.7% after water treatment. In addition, the ratio of PCDFs (pg-TEQ/L to pg/L) in raw water has been only increased from 7.5% (pg/L) to 42.4% (pg-TEQ/L). However, the ratio of PCDFs (pg-TEQ/L to pg/L) in treated water has been drastically increased from 13.3% (pg/L) to 83.8% (pg-TEQ/L). This result shows that the chlorination in water treatment has influenced the formation of dioxins.

3.3 Effect of water treatment on the removal of dioxins

Figure 6 shows the removal rate of total PCDDs/DFs and Co-PCBs by drinking water treatment. The average removal rate of total dioxins in terms of pg/L value was about 93% whereas 87% of total dioxins in terms of pg-TEQ/L value were removed. This result means that most of dioxins and dioxin like compounds can be removed by drinking water treatment such as coagulation, sedimentation and filtration.

Figure 6 also shows that as the substituted number of chlorine increases, the removal rate also increases. This result is also in agreement with the report as the substituted number of chlorine increases it becomes harder to be dissolved in the water. Because of its characteristic, one can assume that it can be easily removed as its particulate state.

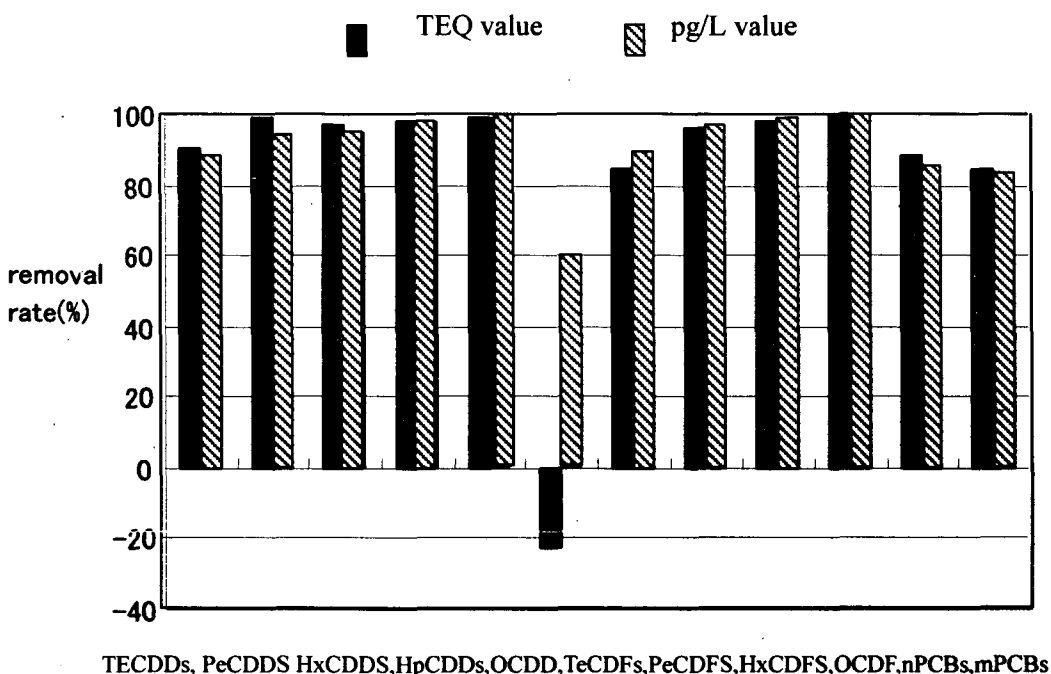

Fig. 6. Removal rate of total dioxins concentration in the drinking water treatment process: mean values of 42 water plants (84 samples)

As indicated in Figure 6, particularly in terms of pg-TEQ/L, removal rate of TeCDFs was minus around 22%. The removal rate of TeCDFs in pg/L value was much lower than average. This reason is the removal rate of 1,2,7,8-TeCDF and 2,3,7,8-TeCDF were minus 14% and minus 22%, respectively. Out of 84 sampling site, the concentration of 1,2,7,8-TeCDF and 2,3,7,9-TeCDF increased in 9 sampling sites and 17 sampling site, respectively. This increase may be attributable to the reaction of chlorine with the precursors of dioxins such as dichlorophenol, trichlorophenol in the process of water treatment.

3.4 Contribution of particulates dioxins to total dioxins levels in raw water

The relationship between turbidity and total concentration (pg/L basis) of PCDDs/DFs and Co-PCBs is shown in Figure 7. It shows as turbidity (kaolin unit) increases, the total concentration of dioxins also increases in the raw water. This result is in agreement with the report that most of dioxins and dioxin like compounds is attached to particulates in raw water (Gotz et al., 1994).

To identify this result more clearly, as shown in table 1, both particulate dioxins

(separated by glass fiber filter) and soluble dioxins (separated by poly urethane foam) were determined and found out that the concentration ratio of particulate dioxins to total dioxins was 96.9% in one water plant and 91.5% in another water treatment plant. This result indicates that wise management of coagulation and sand filtration is necessary to improve the removal efficiency of particulate dioxins in drinking water treatment.

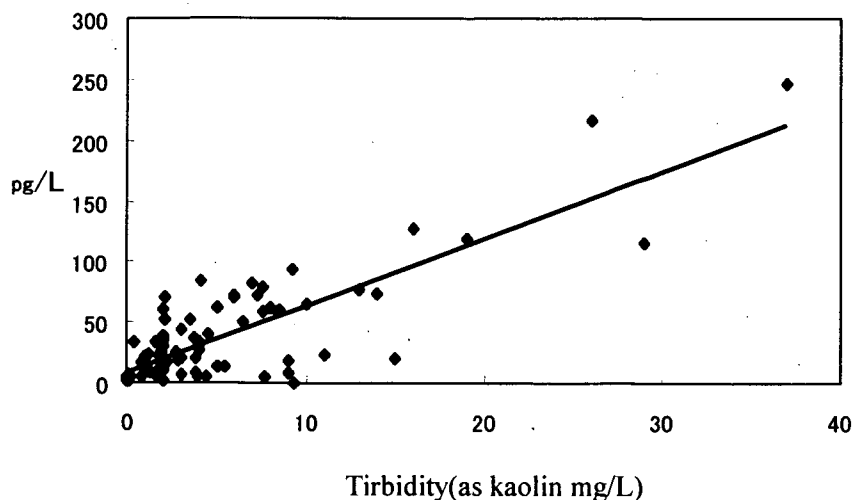

Fig. 7. Relationship between turbidity and total concentration of dioxins

Table 3. Ratio of particulates or soluble dioxins to total dioxins (unit: pg-TEQ/L)

Water plant	Type of dioxins	PCDDs/DFs	Co-PCBs	Total dioxins	Percentage (%)
A	Particulate	0.60	0.019	0.62	96.9
	Soluble	0.0087	0.018	0.020	3.1
B	Particulate	0.26	0.017	0.28	91.5
	Soluble	0.0023	0.0031	0.026	8.5

3.5 Effect of water treatment processes on the removal of total dioxins and homologues

The characteristic of congener on PCDDs/Fs and Co-PCBs was identified in 4 types of water treatment such as chlorination only for ground water (4 water plants, 8 samples), conventional rapid sand filtration (16 water plants, 32 samples), powered activated carbon adsorption with conventional rapid sand filtration (5 water plants, 10 samples) and ozonation followed by BAC (O₃/BAC) with conventional rapid sand filtration (5 water plants, 10 samples). Removal efficiency of total dioxins showed the lowest 87.3% in conventional rapid sand filtration, 89.3% in chlorination only for ground, 89.7% in O₃/BAC treatment and the highest 97% in powered activated carbon adsorption with conventional rapid sand filtration (Fig. 8). This result seems to indicate that powered activated carbon adsorption with conventional rapid sand filtration is more effective than O₃/BAC treatment with conventional rapid sand filtration to remove dioxins in water. In general, however, O₃ / GAC treatment are supposed to be more effective than powdered activated carbon to remove dioxins. Accordingly, it is more likely that BAC used for O₃/BAC treatment system was almost exhausted.

3.6 Origin attribution of dioxins in raw water

The major objective of principal components analysis (PCA) was to determine the PCDDs/DFs and Co-PCBs patterns in the raw water. The patterns were also compared with literature reports of patterns from known sources and from these comparisons; some preliminary observations could be made on potential sources for the PCDDs/DFs and Co-PCBs. Under the assumption that the largest sources of dioxin and dioxin like compounds, on a global scale, are pentachlorophenol (PCP) (S.J. Harrad et al., 1992), 1,3,5-trichloro-2- (4-nitrophenoxy) benzene (CNP) used as herbicide and various combustion sources (R.A. Hites, 1991), PCA was carried out using Stat Flex V5.0 software. The congener group concentrations of tetra- to octa-CDDs, tetra-to-octa-CDFs and non-ortho-, mono-ortho-PCBs as specific congeners were resulted from 37 isomers of PCDDs, 51 isomers of PCDFs and 14 isomers of Co-PCBs.

The results of PCA are shown in Table 4. The first PC is made up with HxCDDs, HpCDDs, OCDD, HxCDFs, HpCDFs, OCDF and its contribution is 64.9%. These specific congeners are representing the PCP due to high relation with five congeners, especially for 1,2,3,4,7,8,9-HpCDF, which were reported to the main constituents of PCDDs/DFs in PCP (Hägenmaier H. et al., 1987, Shigeki Masunaga, 1999). When we consider approximately 175,000 tons of PCP had been used in Japan in 1960s (Takeo Skurai et al., 1998), these specific congeners can be originated from PCP. The second PC is made up with TeCDDs, PeCDDs, TeCDFs, Co-PCBs representing CNP and its contribution is 16.4%. Specific isomers such as 1,3,6,8-TCDD, 1,3,7,9-TCDD and 2,4,6,8-TCDF resulting from herbicide chlorophenols, were reported as the main components of CNP, which had been used in Japan in 1970s (Yamagishi T. et al., 1981). In particular, non-and mono-ortho PCBs are the specific congeners but need to be further studied because the exact sources dioxin-like PCBs is still unknown. The third PC is made up with TeCDDs, PeCDDs, TeCDFs, HxCDFs and its contribution is 7.1%. These isomer patterns are similar to the results of airborne PCDDs/DFs reported in the United States (Eitzer B.D. and. Hites R.A., 1989). The cumulate rate of pesticide (PCP&CNP) was 81.3%. From this result, it can be thought most of Dioxins, Dibenzofurans and Co-PCBs are originated from pesticide not that atmosphere.

Table 4. Origin attribution of dioxins in raw water by PCA

Principal Component	Contribution Rate (%)	Cumulate Rate (%)	Specific Congeners	Matter of Origin
PC 1	64.9	64.9	HxCDDs, HpCDDs, OCDD, HxCDFs, HpCDFs, OCDF	PCP
PC 2	16.4	81.3	TeCDDs, PeCDDs, TeCDFs, Co-PCBs	CNP
PC 3	7.1	88.4	TeCDDs, PeCDDs, TeCDFs, HxCDFs	Atmosphere
PC 4	5.3	93.7	TeCDDs, PeCDDs, OCDD	Uncertainty

PCP and CNP were used as herbicides in paddy fields after the plantation of young rice until 1970th and 1994, respectively. However, because of their carcinogenicity there are not used in Japan. Both of them are synthesized for 2,4,6-trichlorophenol, therefore, it is reported that they content dioxins, especially 1,3,6,8-TeCDD.

Because it has been resulted that the contribution ratio of PCP and CNP to dioxins are high in surface water by multivalent statistical analysis. The amounts of them used in each prefecture are collected by the annual report of pesticides consumption. PCP has summed up its consumption from 1962 to 1986, and CNP has summed up from 1965 to 1995. The amounts of them are calculated by the consumption of marketed herbicide and their contents in the marketed herbicides.

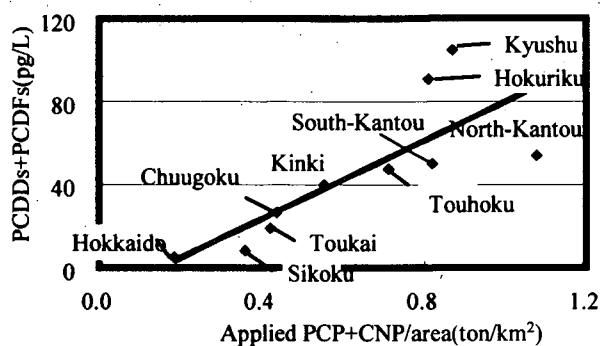

Figure 8 the relationship between Dioxins in raw water and applied herbicides in past

The amount of PCP and CNP in each prefecture was divided by the catchments area of each water source in order to assess the effect of them to dioxins in surface water. The relationship between PCP and CNP load to dioxins concentration is shown in Figure 8. The figure shows there is a clear relationship among them.

4. Conclusions

Raw and treated water samples were collected from 49-water treatment plants throughout Japan over three years. The water source for 44 of the water treatment plants is surface water and the remaining five water treatment plants are fed by ground water. The mean concentration of dioxins in raw water and treated water was 61pg/L (0.14pg-WHO-TEQ/L) and 4.0pg/L (0.015pg-WHO-TEQ/L), respectively. Location of water treatment plants not only significantly influenced the concentration level of dioxins but also resulted in different homologue patterns of dioxins. Levels of dioxins in ground water were much less than that of surface water in both raw and treated water.

The mean TEQ removal rate of dioxins by drinking water treatment was over 89%. It is the reason that the most of PCDDs/DFs and Co-PCBs are associated with the particulates that is easily removed by conventional treatment. However, the mean removal rate of 2,3,7,8-TeCDF by water treatment in the 143 samples was minus 12%. Therefore, to identify which process affected the level of 2,3,7,8-TeCDF, removal efficiencies at both the advanced and the conventional water treatment plant were investigated. For the TEQ removal rate across the processes, the dioxin congeners reduced remarkably after chlorination, in both an advanced and a conventional water treatment plant, were TeCDF and non-ortho-PCBs. From this study, it was clearly identified that the level of 2,3,7,8-TeCDF increased as a reaction in a chlorination.

The multivalent statistical analysis of dioxins congeners shows that most part of dioxin's origin comes from pesticides such as PCP and CNP. Although those pesticides have been restricted their use about ten years or more ago, they remains in agricultural fields and run-off into the water environments. Nevertheless, it is anticipated the dioxins relating with pesticides is gradually decreased. However, the highest concentration of them in raw water is close to the target concentration of drinking water quality, therefore, it is necessary the monitoring activities

of dioxins in specific catchments area used a large amount of pesticides and an appropriate water treatment such as an application of powdered activated carbon.

Acknowledgement

The research grand of Japanese Ministry of Health, Welfare and Labor supported this study.

References

Birmingham B., Gilman A., Grant D., Salminen J., Bodington M., Thorpe B., Wile I., Toft P. and Armstrong V. (1989) PCDD/PCDF multimedia exposure analysis for the Canadian population : Detailed exposure estimation. *Chemosphere* 19 : 637-642.

Czuczwa JM, Hites RA (1984) Environmental fate of combustion-generated polychlorinated dioxins and furans. *Environ Sci. Technol.* 18 : 444-450.

Fiedler H, Schramm KW (1990) QSAR generated octanol-water partition coefficients of selected mixed halogenated dibenzodioxins and dibenzofurans. *Chemosphere* 20: 1597-1602.

Gotz R., Enge P., Friesel P., Roch K., Kjeller L.O., Klup S.E. and Rappe C. (1994) Sampling and analysis of water and suspended particulate matter of the river Elber for polychlorinated dibenzo-p-dioxins (PCDDs) and dibenzofurans(PCDFs). *Chemosphere* 28 : 63-74.

Hagenmaier H. and Brunner H. (1987) Isomerspecific analysis of pentachlorophenol and sodium pentachlorophenate for 2,3,7,8-substituted PCDD and PCDF at sub-ppb levels. *Chemosphere* 16 : 1759-1764.

Japanese Environmental Agency (1998) Gesuishorijouni kakaru daiokisinrui chousakekkani tsuite, kannkouchou kougai senmon shiryuu.

Japanese Environmental Agency (1999) Environmental Standard Regulation of atmosphere, water and land contamination by dioxins. Notification No. 68 of Japanese Environmental Agency.

Magara Yasumoto, Aizawa Takako, Ando Masanoro, Morita Masatoshi, Ito Hiroyasu, Seki Yoshie and Mastumura Tohru (1999) Determination of low dioxins and PCB's concentration in ambient water using large volume "in situ" pre-concentration system. 19th international Symposium Halogenated Environmental Organic Pollutants POPs 40 : 205-210.

Masunaga Shigeki (1999) Nihonno kankyouchuu daiokisinwa nanini urai siteiruka. Mizujouhou, 19(12) : 4-11.

Miyata H., Aozasa O., Ohta S., Chang T. and Yasuda Y. (1993) Estimated daily intakes of PCDDs, PCDFs and Non-ortho coplanar PCBs via drinking water in Japan. *Chemosphere* 26 : 1527-1536.

Sakurai Takeo, Suzuki Noriyuki, Masunaga Shigeki and Nakanishi Junko (1998) Origin attribution of polychlorinated dibenzo-p-dioxins and dibenzofurans in sediment and soil from a Japanese fresh water lake area through congener-specific data analysis. *Chemosphere* 37(9-12) : 2211-2224.

Yamagishi T., Miyazaki T., Akiyama K., Morita M., Nakagawa J., Horii S. and Kaneko S. (1981) Polychlorinated dibenzo-p-dioxins and dibenzofurans in commercial diphenyl ether

herbicides, and in freshwater fish collected from the application area. *Chemosphere* 10 : 1137-1144.

**7. Present status of Combined Sewer Overflow and
New CSO Control Policy in JAPAN**

Presenter

Hiroaki MORITA, Ministry Of Land,
Infrastructure And Transport

Present status of Combined Sewer Overflow and New CSO Control Policy in JAPAN

Hiroaki MORITA

ABSTRACT

There are about 192 cities in Japan that have combined sewer systems. This is only 10% of the cities in Japan that implement sewage works, but these 192 cities account for about one third of the total sewered population in Japan. Of the cities that have combined sewer systems, 31% are currently planning projects to improve their sewerage systems, and 19% are implementing such projects.

The main method of carrying out combined sewer system improvement is to increase the capacity of intercepting sewers, although stormwater storage facilities are also provided when necessary. But many cities in Japan do not understand the characteristics of their sewer systems during wet weather and have insufficient data obtained by monitoring sewer systems.

In April 1999, balls of white oil were found coming ashore in the seaside port at Odaiba Tokyo. Initially it was assumed that these white balls were oil illegally dumped from ships. However subsequent investigations revealed that the oil had been in domestic wastewater discharged from the combined sewer system.

In response to rising public demand, the Japanese Government decided to establish New CSO Control Policy and apply them as national standards and exercise leadership to help local regional governments set improvement plans.

This New Policy was made public in March 2002 after a study of the matter by the Combined Sewer System Improvement Committee comprising representatives from the Ministry of Land, Infrastructure and Transport, the Japan Coast Guard, local authorities and academic experts.

This New Policy calls for the achievement of several goals within the next decade. The Ministry of Land, Infrastructure and Transport, the NILIM, and local governments are working to find solutions to problems with Combined Sewer Overflow (CSO).

Head, Wastewater System Division, Water Quality Control Department, National Institute for Land and Infrastructure Management, 1, Asahi, Tsukuba, Ibaraki, 305-0804, Japan
morita-h92er@nilim.go.jp:

Phone +81-298-64-2328, Fax +81-298-64-2817

KEYWORDS

CSO, combined sewer system, improvement, goal, countermeasure, implementation, stormwater storage facility, 'separate sewer system equivalent', PWRI model

1. INTRODUCTION

In the 1960s, water pollution of rivers worsened throughout Japan, and a critical need for countermeasures against water pollution rapidly came to the fore. Under these circumstances, highly important Water Quality Standards and the Water Pollution Control Law were newly enacted. And a revision of the Sewerage Law in 1970 added contributing to the preservation of water quality in public bodies of water to the purposes of the Law.

It was during this period that the problem of combined sewer overflow finally became a serious concern. Surveys of overflow water quality and investigations into methods for calculating pollution loads were started, primarily at the Public Works Research Institute (PWRI). Based on the results of these surveys and investigations, the Provisional Guidelines for CSO Countermeasures¹⁾ were published in 1982.

Now almost 20 years later, more than 60% of people in Japan are served by sewer systems. There is currently considerable discussion on the development of new sewerage measures for the future, with the key phrase; 'Ensuring a Sound Hydrological Cycle'. Combined sewer system improvement projects are very important in terms of contributing to the creation of fine water environments. However, the number of projects in progress is still insufficient.

This report first organizes the actual condition of combined sewer systems and the present state of countermeasures in Japan, then introduces new combined sewer system improvement policies, in order to summarize the present state of and problems with CSO countermeasures in Japan. Finally the report summarizes challenges facing CSO.

2. CURRENT STATUS OF COMBINED SEWER SYSTEMS

Table 1 shows the cities in Japan that implement sewage works classified according to the collection type²⁾. Only 27 cities predominantly use the combined type, but including cities that have adopted the combined type to at least some extent raises this figure to 192, which is about 10% of the cities that implement sewage works. (The total number of cities in Japan is 3,224 in 2001.)

Table 1 Number of cities classified according to collection type²⁾

Collection type	Combined	Separate	Total
Number of cities	192	2,027	2,219
Served area (ha×10 ³)	227	1,389	1,616
Sewered Population (million)	23	57	80

Fig. 1 shows these 192 cities plotted on a map of the country. It can be seen that those cities that have adopted combined type are distributed throughout Japan. This indicates that problems associated with combined sewer systems are nationwide.

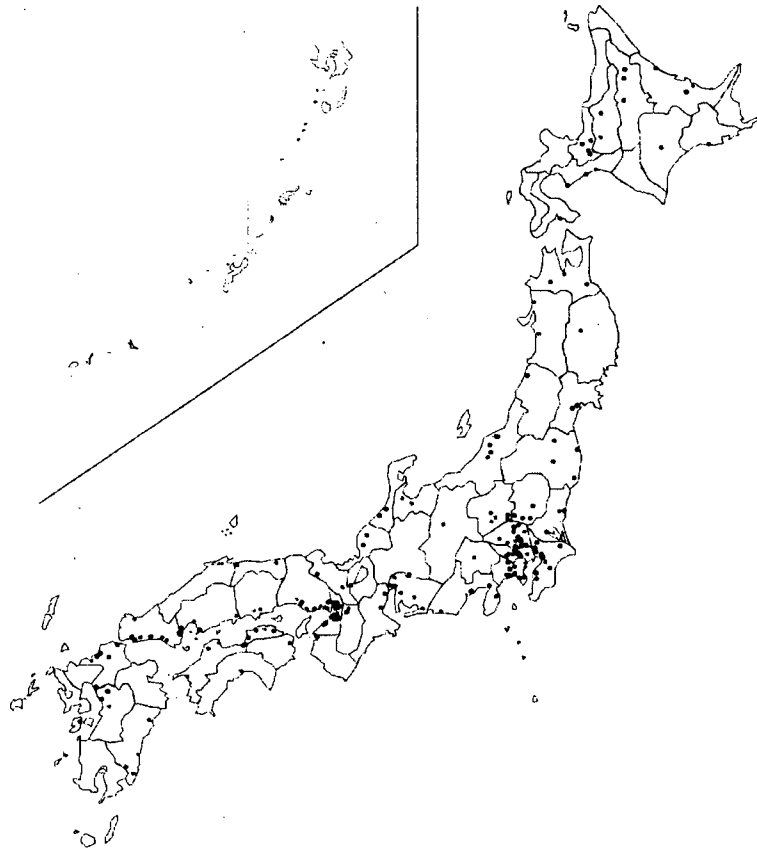

Japan is very mountainous, meaning that only a small proportion of the land is habitable by humans. The population is, therefore, concentrated into small areas, in particular alluvial plains. Accordingly, sewerage first started to become widespread in cities located in these low flat areas. In such cities, it was vital to prevent flooding of the built-up areas and to remove wastewater as rapidly as possible. Because a combined type system is cheap, can be built quickly, and is particularly suited to narrow city streets, many cities selected the combined type at that time.

With the revision of the Sewerage Law in 1970, however, it became a rule that when new sewerage systems were built, they should in principle be separate systems. In more recent years, most of the cities that have introduced sewage works for the first time have been small- or medium-sized cities with relatively low populations. As a result of the above, it is generally the case that the larger the city, the more likely it is to have adopted the combined type. In terms of population, 23 million people live in areas served by combined sewer systems ³⁾, which is about one third of the total sewer population in Japan or about one sixth of the total population of the country.

3. CSO COUNTERMEASURES

3.1 Current Status of Combined Sewer System Improvement Projects

There is no authorized index used in Japan for indicating the degree of progress that has been made in combined sewer system improvement work. However, according to a survey by the MLIT ²⁾ in 2002, the number of the cities that are either implementing or planning improvement projects is about 31 % of the cities that have combined sewer systems and 19% are implementing such projects.(Fig.2)

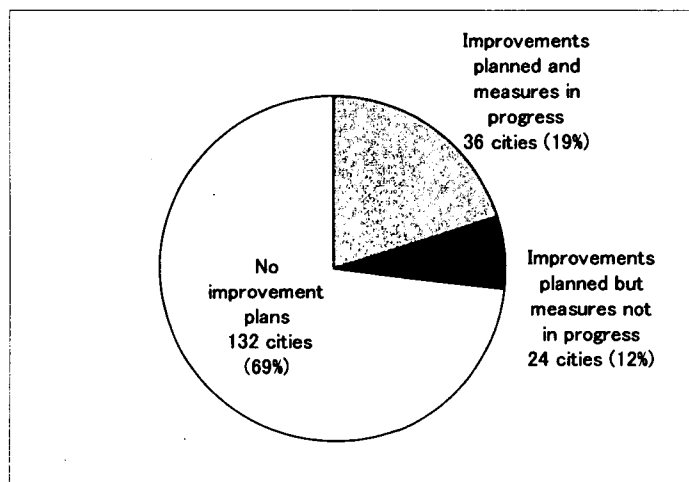

Fig.2 State of Improvement Plans in Cities

The only cities that are actively pushing forward with improvement projects are the large cities that have a very high percentages of the sewered population and some of the cities that have closed bodies of water. In cities where many people are unsewered, priority is being given to new sewerage system construction projects rather than to combined sewer system improvement projects. Considering sewerage projects as a whole, this is quite a natural situation, and in addition, from the standpoint of reducing the pollutant load on public waters, it is considered more effective to give priority to the construction of new sewerage systems than to the improvement of combined sewer systems.

The main combined sewer system improvement measure taken is to increase the capacity of intercepting sewers. Intercepting sewers are generally designed to have a capacity of $3Q$, where Q is the maximum hourly wastewater flow rate. In addition, in order to effectively achieve the previously mentioned goal of a 'separate sewer system equivalent', in some cases there are plans for offsite storage facilities such as storage tanks or storage sewers for pollution control. According to a survey by the PWRI⁴⁾ in FY 1994, 32 stormwater storage facilities constructed to improve combined sewer systems were in operation. If facilities that are currently under construction or being planned are included, this figure rises to 80. It should be noted, however, that almost half of these facilities have been constructed/planned not purely for combined sewer system improvement purposes but also as flooding prevention measures. When constructing such storage facilities for combating CSO, one of the biggest problems is obtaining the required land. In the case of a storage tank for pollution control, a large site is required. If suitable land cannot be found, it is common to build storage sewers under roads. In this case, it is necessary to confer with the road administrator, but not to obtain the land.

It is not the case that all cities are adopting these kinds of methods. For example, there are cities where various restrictions make it difficult to increase the capacity of intercepting sewers, so plans have been made whereby the countermeasures will involve only offsite storage facilities and not intercepting sewers. There are also about 20 cities that are either implementing or planning projects in which their combined sewer systems will be changed to separate sewer systems. There are two ways of doing this depending on the condition of the individual drainage basin. One involves using the existing combined sewers as stormwater sewers and the other involves using them as sanitary sewers.

Onsite stormwater infiltration facilities are also gradually being introduced. These facilities also offer an effective way of carrying out combined sewer system improvement. In 1994, the Ministry of Construction set up a system under which sewage works administrators are given subsidies to help with the establishment of such facilities. However, it is difficult to quantitatively measure the positive effects of such measures and

so such facilities are, for the time being, regarded as no more than additional facilities.

3.2 Typical Examples of Facilities to Fight CSO

There are 3 representative types of facility that are used as countermeasures against CSO – pollution control storage tanks, pollution control storage sewers and stormwater sedimentation tanks. Below is a brief introduction to actual examples in which each of these types of facility have been used in Japan.

In the case of the Fukue Stormwater Storage Facility in Nagoya⁵⁾, it is planned to act both as a CSO countermeasure facility and as a flooding prevention measure. It started operating in FY 1999. The total area of the site is 5,850m², with the storage tanks situated underground so that the land above can be used effectively, as an urban industrial park for example. When full, the depth of water in the storage tanks will be 13m. As shown in Fig. 3, the storage tanks are split into three blocks – a tank for exclusive use as a flooding prevention measure (A: capacity 5,000m³), a tank for exclusive combined sewer system improvement use (B: capacity 9,000m³), and a tank for joint use (C: capacity 17,000m³). The area of the district targeted for combined sewer system improvement is 437ha. If only tank A is used, stormwater corresponding to 2mm/h of rainfall can be stored. And if tank C is also used, then stormwater corresponding to 6mm/h of rainfall can be stored. The issue to be addressed in the future is how to carry out real-time control of the joint-use tank based on rainfall information.

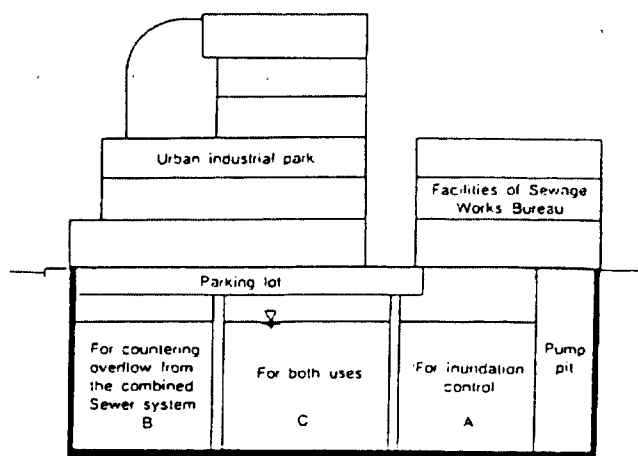

Fig. 3 Fukue Stormwater Storage Facility in Nagoya⁵⁾

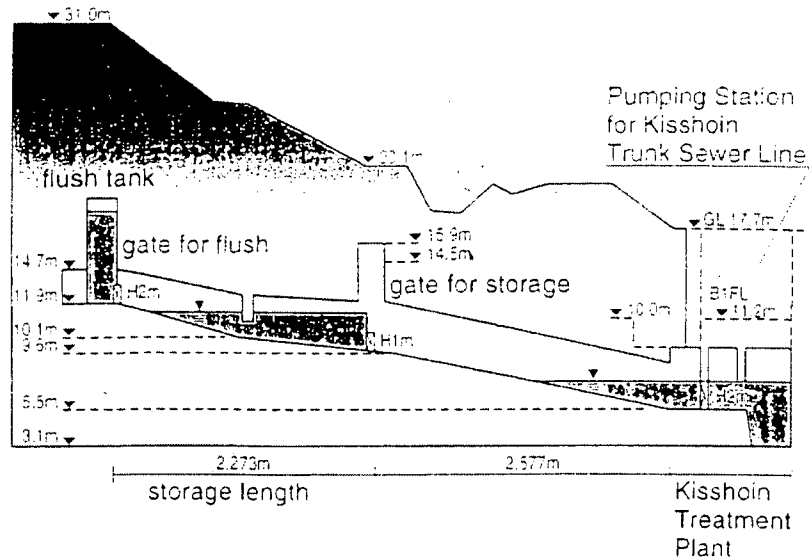

Fig. 4 Kisshoin Trunk Sewer in Kyoto⁶⁾

In the case of the Kisshoin Trunk Sewer in Kyoto⁶⁾, a storage sewer for pollution control went into operation in 1994. Once again, the facility not only provides combined sewer system improvement effects, but also acts as a flooding prevention measure. As shown in Fig.4, in the central area of the trunk sewer, there is a gate used to stop the flow of water and the upstream side of this gate acts as a storage sewer for combined sewer system improvement. The length of the trunk sewer used for this purpose is 2,273m and its diameter is 2.8m.

The storage capacity of the sewer is 13,000m³, which means that because the district targeted for combined sewer system improvement is 346ha in area, the storage capacity corresponds to 5mm/h of rainfall (runoff coefficient is 0.7). Stored sewage water is sent down to the wastewater treatment plant during dry weather so that it can all be treated. A survey to evaluate the effects of combined sewer system improvement is currently underway.

The Oshima Stormwater Reservoir in Kawasaki⁷⁾ that started operation in 1991 is used only to improve the combined sewer system. The tanks of the reservoir are rectangular, with a width of 20m, a length of 29m and a depth of 4.5m. Because there are 8 tanks, the reservoir's total storage capacity is 21,000m³. The district targeted for combined sewer system improvement is 393ha in area, meaning that the total storage capacity of the tanks corresponds to 5mm/h of rainfall. The storage tanks are situated behind the pumping station, meaning that even if they should become full, they can be used as stormwater sedimentation tanks by allowing stormwater to continue flowing into them. According to the results of a survey conducted by Kawasaki City, the removal efficiency of BOD by sedimentation was 30~76 % and that of SS was 44~78 %.

4. New CSO Control Policy

In April 1999, white oil balls were found coming ashore in the seaside park at Odaiba, Tokyo. Parents of children playing on the beach reported this to the Japan Coast Guard that was monitoring the water quality of Tokyo Bay. Initially it was assumed that these white balls were oil illegally dumped from ships. However subsequent investigations revealed that the oil had been in domestic wastewater discharged from the combined sewer system.

On September 25, 2000, the Mainichi Shimbun, a daily newspaper, reported that white oil balls were drifting ashore at Odaiba Seaside Park along Tokyo Bay, and said that this was an indication that the aquatic environment of Tokyo Bay was worsening.

Moreover, on August 8, 2001 and October 17, 2001, NHK TV (the national broadcasting system) programs reported to nationwide audiences that contaminants from the combined sewer system were being discharged into rivers and sea areas. Large numbers of citizens learned this fact about combined sewer systems for the first time. These newspaper reports and programs resulted in an increasing number of requests to sewerage authorities to improve combined sewer systems⁸⁾.

In June 2001, the Government of Japan responded to this situation by forming a committee of experts and officials from local governments to promote the introduction of measures to control CSO. The committee is conducting studies to clarify the actual state of the CSO problem (duration of overflows, water quality of overflows and receiving bodies of water etc.), CSO countermeasures, and their goals.

After studying this matter, the Combined Sewer System Improvement Committee comprising representatives from the Ministry of Land, Infrastructure and Transport, the Japan Coast Guard, local authorities and academic experts, made its final report public in March 2002.

This final report has no legal force, but actually presents Japanese Government policy concerning CSO countermeasures. That is why it is called a guideline. The following are key points in the report.

(1) Items concerning improvement goals

The improvement goals include a long-term goal and a short-term goal. The short-term goal is to be reached within 10 years. (setting staged goals and early achievement of their effects)

The long-term goal is to perform wet weather control to separate contaminated water from stormwater in order to absolutely minimize the discharge of untreated water during wet weather. In other words, aggressive conversion of combined sewer systems to

separate sewer systems and the promotion of seepage to store water on-site.

In the short term, priority will be placed on urgent highly efficient projects necessary to achieve the long-term goals and setting targets for the following three goals in all cities with a combined sewer system.

[1] Reduction of pollutant loads (continuation of past goal)

Reduction of the total annual BOD discharged from a combined sewer system to a level equal to or lower than that of a separate sewer system.

[2] Guaranteeing public hygienic safety (new goal)

To achieve a big reduction in the discharge of untreated wastewater into public bodies of water, halve the frequency that water is discharged from all outlets at drainage facilities and pumping stations.

[3] Reduction of large solids (new goal)

Prevention of the discharge of large solids from all outlets of drainage facilities and pumping stations.

In bodies of water where it is important to conserve water quality and which are particularly susceptible to the effects of water discharged during wet weather (sensitive area : areas where there is a public water supply intake, swimming areas, etc.), closing or moving outlets, the sterilization of pumping systems and other ways to strengthen countermeasures will be studied without being limited to the above three items.

(2) Items concerning the implementation of improvement measures

A combined system improvement plan that stipulates the way to achieve the short term goals will be enacted, items in the plan that concern facility improvement will be reflected in projects stipulated under the Sewerage Law, and countermeasures will be introduced quickly. (clarification of the legal position of the combined system improvement plan).

The combined system improvement plan will be enacted accounting for the results of complete studies of the present state of sewerage systems, state of discharge during rainy weather, and its effects on the receiving waters (preliminary monitoring), and during implementation of the countermeasures or after they have been completed, continuous monitoring of discharge during rainfall (post-improvement monitoring) will be done to clarify the combined system improvement effects of implementing the countermeasures and of the maintenance of sewerage systems. In addition, it will be necessary to set new discharge management indices that can be used to confirm whether or not the implementation of the countermeasures has reduced the pollution load discharged during rainy weather as stipulated by short term goal (1) (management indices for water discharged during wet weather).

Information such as the results of the monitoring and progress in improvement measures will be provided to the river basin residents and concerned organizations, and at

the same time, measures will be introduced to encourage assistance and cooperation to install storage and seepage systems at individual buildings and clean urban districts.

Figure 5 is a chart representing the above program.

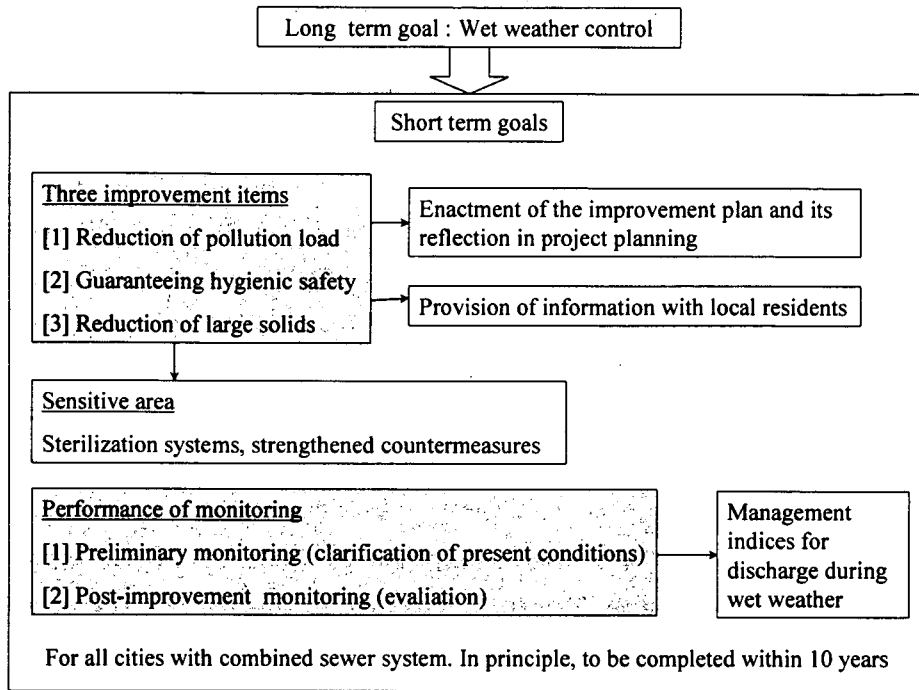

Fig.5 Key Points of the Basic Concepts in the Committee's Proposal

5. ISSUES AND SOLUTIONS

5.1 Technical issues

There are two main technical problems to be resolved to draw up a combined sewer system improvement plan. The first is that, when looking into countermeasure scenarios that consider the sewer network, it is very difficult and complicated to apply the PWRI model (which is used for calculating pollutant loads) because it is a lumped-parameter type model. In order to solve this problem, the PWRI and the Japan Sewage Works Agency have decided to conduct joint research starting this year to make improvements to change the PWRI model into a distribution type model that is easy to use and befits the current age. Moreover, in recent years distribution type models such as Hydro Works, MOUSE and SWMM that have been developed and put to practical use in other countries have come on the market, and so the PWRI has looked into the possibility of using such models in Japan⁹⁾.

The other problem is that when performing calculations to compare a combined sewer system with a separate sewer system, the setting of the stormwater quality for the separate sewer system is not well grounded. Stormwater quality is one of the most important factors that determines the size of CSO prevention facilities, but the current situation is that there is a lack of actual measurement data for almost all cities. The PWRI has conducted surveys into stormwater quality under wet weather conditions in the past and has published the results in the form of a database, but there are great differences in the stormwater quality from area to area, and indeed great fluctuations from one rainfall to the next, meaning that it is necessary for surveys to be carried out and for data to be collected in all cities.

Moving on to other technological issues, there are a number of different types of investigations currently being carried out in Japan as follows.

- Structures of storm overflow chambers.
- Filter screens which provide a simple technique to prevent CSO.
- Treating intercepted wastewater under wet weather conditions.
- Predicting rainfall using radar rain gauges with the aim of enabling real-time control
- Dual usage of flood prevention facilities for combined sewer system improvement

5.2 Issues relating to Project Implementation

There is one main issue relating to the best way to push forward with combined sewer system improvement projects.

Drawing up project plans is important from the standpoints of the recognition of the necessity of the improvement projects, the responsibility of the authorities to give explanations, the effective implementation of projects, and the early achievement of

improvement effects.

Even in the case of cities that are already carrying out combined sewer system improvement projects, it is often the case that no firm target date for the achievement of the goals has been set. It is thought that the main reason for this is the vast budget and long time required for combined sewer system improvement. It would seem that, in cases where it is hard to set a date when the long-term project goals should be achieved, it is necessary to set short- or mid-term goals and target dates for their achievement, and to push forward with the project at each stage.

Recently in Japan harsh questions have been asked regarding the transparency and efficiency of public works projects. This means that with regard to public works projects that require enormous budgets, it is vital to publicly disclose ample information on the necessity of the projects, and thus strive to obtain the consensus of residents. In particular, the CSO countermeasure projects fall under the category of projects for which insufficient explanation has been given to residents in the past, and so it would seem to be necessary to start by ensuring that residents have an awareness of why CSO constitutes a problem and of the issues involved.

If combined sewer system improvement projects are implemented following the kind of project plans that have been described above, we will then be able to expect results to be achieved in terms of improvements in water quality at an early stage.

6. CONCLUSION

While the public's concern with CSO is mounting, many points concerning the actual state of CSO and its effects on the receiving water bodies are unclear because there are few studies of these matters.

In the near future, local governments that operate combined sewer systems are expected to carry out fact-finding surveys and publicly release the results, and to clearly inform their residents of their determination to improve CSO improvement countermeasures. In the future, they must work aggressively with all concerned parties to transform combined sewer systems into sewer systems suited to twenty-first century cities.

REFERENCES

- 1) JSWA (1982) : Provisional Guidelines for CSO Countermeasures. (in Japanese)
- 2) MLIT (1998) : Final Report on Research on CSO Control Strategies, Sewage (in Japanese)
- 3) MOC (1992) : Research on Improvement of Combined Sewer Systems. (in Japanese)
- 4) PWRI (1995) : Technical Memorandum of PWRI, No.3374, 159-168. (in Japanese)
- 5) Owaki (1995) : Improvement of a Combined Sewer System for Flood Control and Water Pollution Control in the City of Nagoya - Case of "Fukue Stormwater Storage Facility"- , Proc. of 6th WEF/JSWA Joint Seminar on Sewage Treatment Technology, Tokyo, Japan, 193-205.
- 6) Suzuki (1997) : Measures against Combined Sewer Overflows by Storage Sewers, Technical Memorandum of PWRI, No.3580, 287-299.
- 7) Okabe (1991) : Utilization of a Stormwater Reservoir as a Sedimentation Tank for Stormwater in Kawasaki City, Journal of JSWA, 28 (327) 25-29. (in Japanese)
- 8) Shoichi Fujita (2002): Full-Fledged Movement on Improvement of the Combined Sewer System and Flood Control Underway in Japan, 9ICUD proceedings.
- 9) PWRI (1996) : Technical Memorandum of PWRI, No.3528, 133-142. (in Japanese)

**Present status of Combined Sewer
Overflow and
New CSO Control Policy in JAPAN**

Hiroaki MORITA

Wastewater System Division, Water Quality Control Department,
National Institute for Land and Infrastructure Management,

Table 1 Number of cities classified according to collection type²⁾

Collection type	Combined	Separate	Total
Number of cities	192	2,027	2,219
Served area (ha×10 ³)	227	1,389	1,616
Sewered Population (million)	23	57	80



Fig.1 Cities that have adopted a combined sewer system in Japan

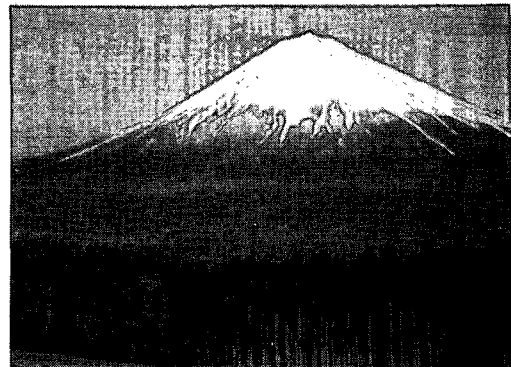
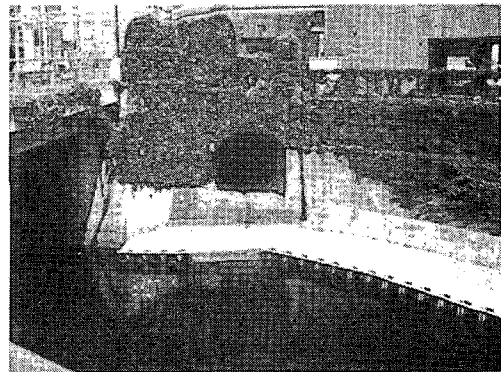

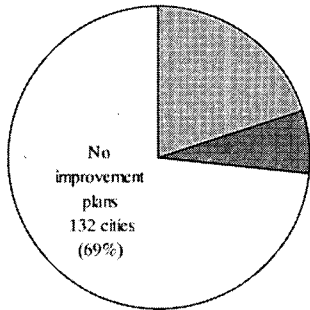
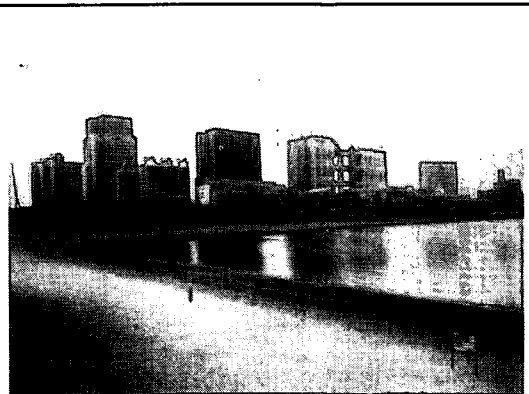
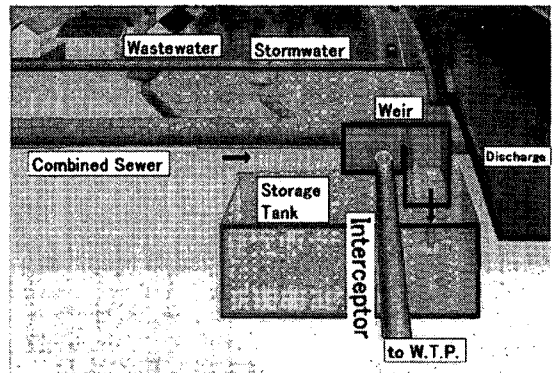
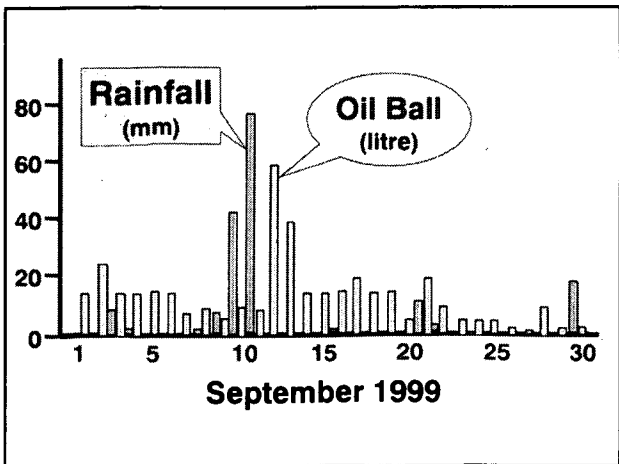
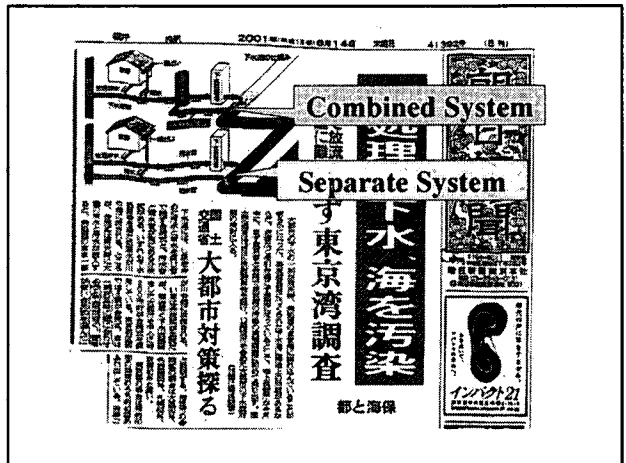
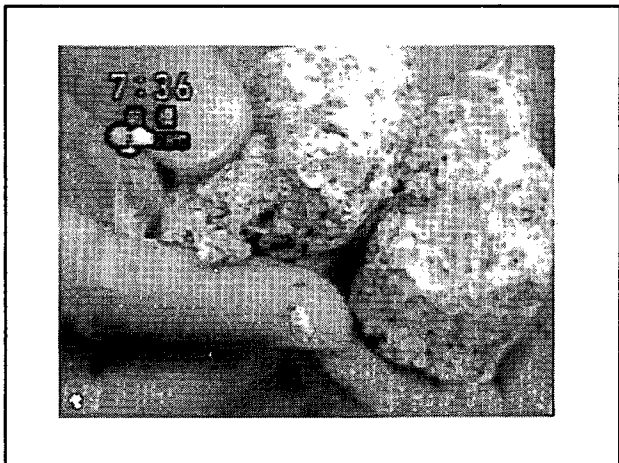
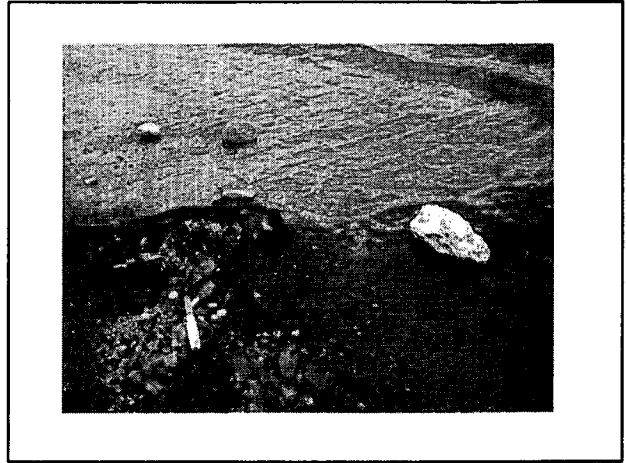

Fig.2 State of Improvement Plans in Cities





**The Combined Sewer system
Improvement Committee**

- Organized in June 2001
- Ministry of land, Infrastructure and Transport, the Japan Coast Guard, Local government and academic experts
- Final report was released in March 2002

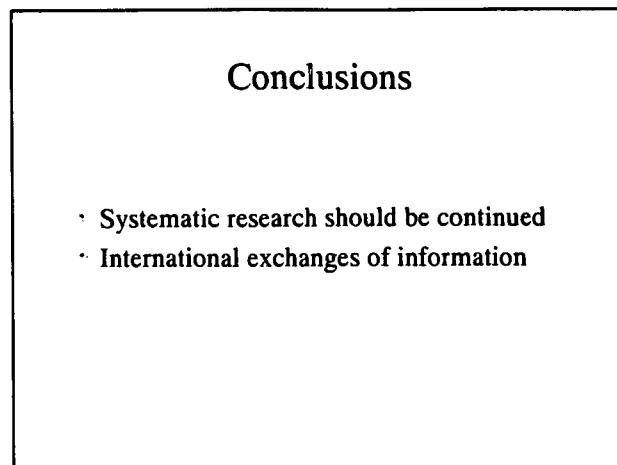
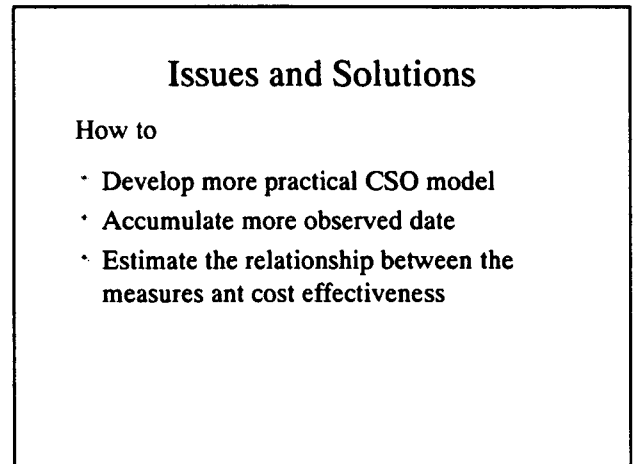
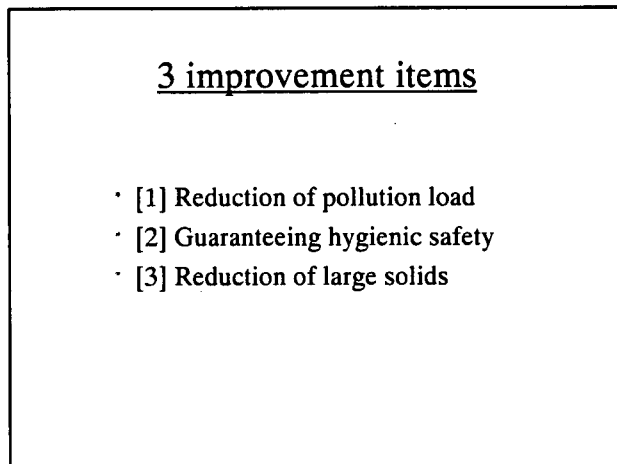
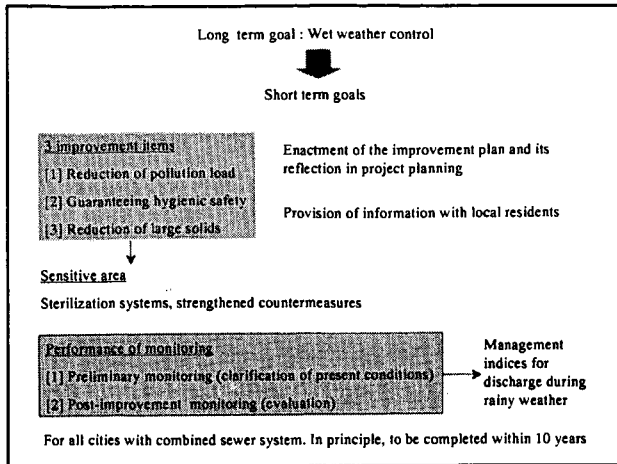

8. Watersheds, Stormwater, Source Water Protection

Presenter

Tyler Richards, Water Environment Research Foundation



Water Environment
Research Foundation

Watersheds, Stormwater, Source Water Protection

Tyler Richards
October 2002

The Watershed Management Approach

- Holistic approach
- Evaluating water quality through
 - Land
 - Water
 - Air
- Observing
 - All land uses
 - Potential pollution sources

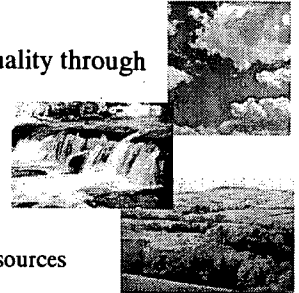

The Watershed Management Approach cont.

- Focusing on
 - Maintaining water quality
 - Improving water quality
- For viable and healthy ecosystems



The Watershed Management Approach cont.

- Parallels Source Water Protection
 - Can emphasize urban & urbanizing watersheds
 - Source Water looks at drinking water sources

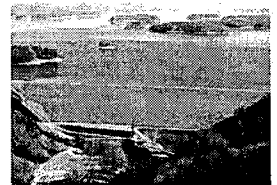

Watershed Management Drivers

- Clean Water Act goal
 - all waters should be fishable and swimmable
- Recent understanding that improving point sources only will not ensure goals are met
- Address other sources of pollution, like storm water runoff
- Looks at all pollution sources and various ways to cost-effectively reduce pollution



WERF Research—Watershed Management Topical Areas

- Effective Water Quality Tools
- Effective Management Strategies and Tools
- Total Maximum Daily Loads
- Addressing Regulatory Mandates
- Aquatic Ecosystem Health



WERF Research Examples— Watershed Management

- Sensor Technology for Water Quality Monitoring: XRF Spectroscopy
- Validation of underlying assumptions for integrating frequency, magnitude, and duration in NPDES permit conditions
- Global lessons for watershed management in the United States



Strategies for Sustainable Water Resources Management

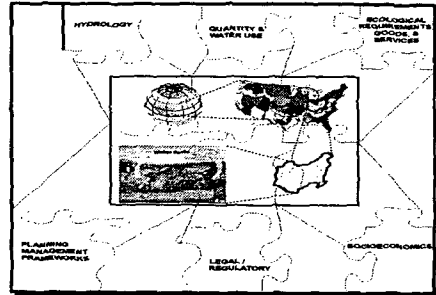

from Kent Thornton, FTN associates for WERF project 00-WSM-6

WERF Research Examples: Complying with CWA through the Watershed Approach

- Total Maximum Daily Load (TMDL) research
 - How to evaluate health and impairment of waterways?
 - How do you apply narrative criteria (trash, toxicity, water clarity)
 - How do you identify and address pollutants in sediments?
 - How do you develop site specific nutrient limits?

Stormwater Drivers

- Clean Water Act
 - requirement to address water quality in stormwater runoff
- Flood Control
 - protection of life and property



Stormwater Drivers *cont.*

- Increases in impervious surfaces and population
 - increased effects from stormwater runoff



WERF Research: Stormwater

- Identify and address research needs for stormwater utilities and municipalities charged with managing stormwater quality and quantity.
- Will provide technical information for efficient and cost effective conveyance and management of stormwater flows
 - To prevent urban flooding and protect surface and ground water quality.

WERF Research: Stormwater

- Range of Conveyance and Treatment Methods
- Post-project monitoring of BMPs/SUDS to determine performance and whole-life costs
- Impacts of stormwater on receiving waters and watersheds
- Anticipate some Low Impact Development and “raingarden” research
 - parallels ongoing research in Japan

Source Water Protection

- Similar to Watershed Management approach but focuses on protecting drinking water sources
 - applies to both surface and groundwater sources



Source Water Protection Drivers

- Safe Drinking Water Act
 - Requires maintenance of safe, clean sources of drinking water
- Recent understanding that all pollution sources impact drinking water safety and treatment cost
- Keeping pollutants out of drinking water sources is safe and cost-efficient approach

Source Water Protection Drivers ^{cont.}

- High level of interest in protecting source waters from pathogens such as Giardia and Cryptosporidium
- May have to balance the need for safe drinking water with other needs
 - Recreation
 - Agriculture
 - energy production



Source Water Protection Research: Topical Areas

- Contaminant Sources and Occurrence
- Fate and Transport
- Monitoring and Analysis
- Source Water Protection Tools



Source Water Protection: Research Examples

- Chemical Occurrence Datasets for Source Water Assessments (AWWARF):
- Pathogens:
 - Sources of Cryptosporidium in Watersheds (WERF/AWWARF)
 - Field Calibration and Verification of a Pathogen Transport Model (WERF)
 - Fate and Transport of Surface Water Pathogens in Watersheds

Source Water Protection: Research Examples

- Source Water Watershed Protection:
 - Source Water Protection Alliances Between Water Utilities and Agricultural Operations (AWWARF)
 - Decision Support Framework for Sustainable Water Supply Planning (AWWARF)



Questions??



**9. Research Agenda in Drinking Water / Wastewater
Control**

Presenter

Dr. Shoichi KUNIKANE, National Institute of Public Health

JAPANESE RESEARCH AGENDA IN DRINKING WATER CONTROL

Shoichi Kunikane

ABSTRACT

Researches on drinking water supply is becoming more important than before in Japan, and the Ministry of Health, Labor and Welfare(MHLW) is going to review its R & D strategy in drinking water supply. A new movement of water supply administration, like decentralization, may accelerate the development of water supply technologies. At present, main subjects of on-going and future researches include a sound water cycle in watershed, safe water plan, measures against terrorism and accidental contamination, *Cryptosporidium* control, endocrine disrupting chemicals, hydrophilic hard-degradable chemicals, and domestic water supply equipment.

INTRODUCTION

Now the regime of drinking water supply in Japan is going to change drastically and rapidly through the deregulation of drinking water supply administration. MHLW already allowed private sector participation in drinking water supply in April 2002. Under such a situation, researches on the control of drinking water quality is becoming more important than before.

In this paper, current research topics related to drinking water quality control in Japan are discussed.

BACKGROUND AND GENERAL TREND

The drinking water supply in Japan is recently becoming more flexible and open to the public than before due to a new movement of deregulation in drinking water supply administration. Such a movement is expected to accelerate research and development of drinking water supply technologies with high reliability and good performance.

MHLW enforced the Water Supply Facility Standards in April 2000. The standards newly established are characterized not as specification standards but as performance standards because the technologies of drinking water supply in Japan have been well

Shoichi Kunikane: Department of Water Supply Engineering, National Institute of Public Health, Shirokanedai 4-6-1, Minato-ku, Tokyo 108-8638, Japan

established and we do not need specification standards any more. Moreover, MHLW considers that it is very important to make drinking water supply systems freely develop their facilities taking their individual situations into account. So a water supply system can adopt any water supply technology under its own responsibility so long as the technology meets the facility standards.

MHLW also enforced the amended Water Works Law in April 2002. The amendment allows a drinking water supply system to commit its management and operation to a third party including the private sector. This is also along with the movement of deregulation in drinking water supply administration.

Regarding research and development, MHLW organized the Committee on R & D in Drinking Water Supply for the purposes of reviewing on-going R & D projects and discussing future directions of R & D in the field of drinking water supply in April 2002. It has been agreed in the committee that discussions will not be confined to the present frame of the drinking water supply system. The discussions of this committee is expected to contribute to the improvement of R & D strategy in drinking water supply.

Another important issue related to researches in drinking water supply technologies is the initiation of a series of research projects on the establishment of a sound water cycle in watershed as written below. This research area, with the aspects of resource and energy saving, and environmental friendliness, is one of those which are considered indispensable for the sustainable development of Japan in the future.

At present, MHLW is going to revise the Drinking Water Quality Standards, where all the parameters listed not only in the standards but also in other guidelines will be reviewed. The meeting of the Committee on Drinking Water Quality Control started in August 2002, and it is planned to review regulations related to drinking water quality control together with them. Therefore, researches and surveys contributing to the revision are also being conducted.

ESTABLISHMENT OF A SOUND WATER CYCLE IN WATERSHED

The Council for Science and Technology Policy, which was organized in the Cabinet Office in 2001, launched a new national big five-years' research project in the areas of life science, information/communication technology, environment, and nano-technology/material in 2002. A research project in the area of environment includes a sub-project with an objective of establishing the sustainability of the environment and ensuring the coexistence of human beings with natural ecosystem, one of whose components is a research project on the establishment of a sound water cycle

in watershed. MHLW takes part in this research project together with the Ministry of Education, Culture, Sports, Science and Technology, the Ministry of Agriculture, Forestry and Fisheries, the Ministry of Land, Infrastructure and Transport, the Ministry of Environment and other ministries. Table 1 shows a list of research subjects granted by MHLW.

Table 1 Research subjects on the establishment of a sound water cycle in watershed

No	Research subject	Main research institution
1	Development of a new water treatment and distribution system considering the establishment of a sound water cycle of a regional scale	Japan Water Research Center
2	A new household water supply system contributing to the saving and reuse of water and the reduction in environmental loads	Japan Water Plumbing Engineering Promotion Foundation
3	Measures against infectious micro-organisms considering the establishment of a sound water cycle	Setsunan University
4	Possibility of a new water management system for creating a healthy water environment	Environmental Science Center, the University of Tokyo
5	Evaluation and monitoring of the water quality of a lake used as a drinking water source with the method of DOM fractionation	National Institute for Environmental Studies
6	Conservation of raw water for drinking water supply using a GIS system	National Institute of Public Health

The Japan Water Research Center(JWRC) launched a three-years' research project on the Environmental, Ecological, Energy Saving and Economical Water Purification System("e-Water" Project) in 2002 under a subject listed in Table 1 following a precedent five-years' research project on the Advanced Aqua Clean Technology for the 21st Century("ACT21" Project). This new project includes the development of large-scale membrane filtration technologies, the development of a new total system for the optimization of drinking water treatment, and the improvement of monitoring technologies for source water quality.

Other research projects related to the establishment of a sound water cycle in watershed include the one on the development of a new water abstraction technology. The objective of this research is to develop a environmentally-friendly surface water abstraction technology with minimizing the intake of suspended matter. The research project will be initiated by the National Institute of Public Health(NIPH) in 2003.

SAFE WATER PLAN

Safety of drinking water is the ultimate goal of its management. Drinking water quality standards are the most important tools for attaining the goal. As already written, MHLW started to review the standards referring to the revision of the WHO Guidelines for Drinking-Water Quality(GDWQ). Research studies on many regulated/unregulated chemicals and microorganisms, whose result will give a scientific basis for the revision of the Japanese standards, are being conducted since several years ago.

The revision of the WHO/GDWQ includes the preparation of the 3rd edition guidelines and many other supporting documents. One of the important supporting documents is “Water Safety Plans,” which elucidate a holistic approach to ensure drinking water safety with good practices for health risk reduction in the whole processes of drinking water supply from a source to a tap. Such an approach is considered important also in Japan, and it will be taken into account in the revision of the Drinking Water Quality Standards.

The Water Supply Facility Standards are our important tools for drinking water quality control as well as the Drinking Water Quality Standards. However, some additional standards on the operation and maintenance of drinking water supply seem necessary in order to ensure drinking water safety. Therefore, researches in this respect should also be undertaken.

OTHER IMPORTANT RESEARCH ISSUES

MEASURES AGAINST TERRORISM AND ACCIDENTAL CONTAMINATION

Interest in drinking water contamination caused by terrorism is growing in Japan, and researches on the measures against such contamination are becoming more important. Some water supply systems in Japan have already prepared their own manuals and strengthened measures against drinking water contamination by terrorism. In Japan, we depend mainly on surface water sources which are vulnerable to accidental contamination. Therefore, researches on the measures against accidental raw water contamination are also very important. MHLW issued the Manual for Preparing Risk Management Procedures to be Taken in an Emergency Related to Drinking Water Contamination in 1999, and it is utilized by drinking water supply systems.

Considering the potential risk of terrorism, the National Institute of Infectious Diseases(NIID) conducted a research on the development of a rapid and sensitive method for the detection of microbial contaminants in drinking water as a means of

anti-bio-terrorism in 2001. One of the main objective of this research was to develop a sampling device for microbial contaminants in water. The device is equipped with a membrane filtration unit and a refrigerator to store concentrated water samples.

CRYPTOSPORIDIUM CONTROL

The efficient removal and control of *Cryptosporidium* is an urgent issue in drinking water supply in Japan as in many other developed countries. Researches on *Cryptosporidium* have been conducted for the past several years in Japan, and the focus at present is its health-risk assessment and management. One of the topics being discussed in the course of reviewing the Drinking Water Quality Standards is the necessity and possibility of establishing a standard value on *Cryptosporidium*.

MHLW has issued the Provisional Guidelines against *Cryptosporidium* in Drinking Water Supply in 1996(revised in 1998 and 2001). The guidelines require a drinking water supply system to install a filtration facility and to maintain the turbidity of filtrate at not more than 0.1 unit where there is a potential risk of raw water contamination with *Cryptosporidium*. Japan did not experience an outbreak of cryptosporidiosis since the one in Ogose Town, Saitama Prefecture, in 1996 because drinking water supply systems pay adequate attention to the control of *Cryptosporidium* according to the guidelines.

UV irradiation seems a promising technology for the control of *Cryptosporidium* in drinking water treatment. Its effectiveness has already been established well, and Setsunan University has initiated a research on the development of its practical application in 2002 as listed in Table 1.

INFORMATION COLLECTION ON ENDOCRINE DISRUPTING CHEMICALS

Endocrine disrupting chemicals(EDCs) is one of the issues of great concern in the field of drinking water supply. Although the health risk potential of EDCs is still not known well, people are very anxious about the contamination of drinking water, as well as food, with them. The main subjects of current researches on EDCs in drinking water conducted by NIPH and Hokkaido University are occurrence in raw and drinking waters, removal and behavior in drinking water treatment and release from materials used for drinking water supply. The EDCs focused on are dioxins, diethylhexyl phthalate, dibutyl phthalate, bisphenol A and nonyl phenol. So far, much information on these chemicals has been accumulated(refer to another paper presented in this conference).

MEASURES FOR THE CONTROL OF HYDROPHILIC HARD-DEGRADABLE CHEMICALS

Raw and/or treated water contamination with hydrophilic hard-degradable chemicals, such as 1,4-dioxane, methyl-*t*-butylether(MTBE), acrylamide monomer and bromate, is of concern in drinking water supply because they cannot be easily removed by a conventional water treatment system, i.e. coagulation/sedimentation and sand filtration, or activated carbon treatment. Therefore, MHLW has initiated a research on their control collaborating with National Institute of Health Sciences(NIHS) and NIPH. The research includes the development of analytical methods, survey on uses for industrial and other purposes, survey on dietary uptake, the mechanism of toxic effects, occurrence in water environment, and removal and behavior in drinking water treatment.

It has been found so far that the contamination of raw water used for drinking water supply with 1,4-dioxane is generally not serious in Japan, but ground waters in some areas are heavily contaminated with it. Ground water abstraction in such areas has been stopped since then. Raw water contamination with MTBE seems not so serious, and its production is going to be reduced in Japan. MHLW approved the use of polyacrylamide for drinking water treatment in 2000. Although there is still no drinking water supply system using this chemical, the development of analytical method of acrylamide monomer at very low concentration and the investigation on its behavior in drinking water treatment processes, e.g. chlorination, are important issues. It is well known that bromate is formed in ozonation process if much bromide ion exists in raw water, but its formation can be reduced even in such a case through the optimum control of the process. There are about 50 drinking water treatment plants adopting ozonation in Japan at present, and the surveillance on bromate formation at these plants are needed. Moreover, as bromate is also used for other purposes, like hair treatment and food processing, raw water for drinking water supply already contains a certain amount of it depending on a local situation.

PROPER MANAGEMENT OF DOMESTIC WATER SUPPLY EQUIPMENT

The proper management of domestic water supply equipment, i.e. service pipes and fittings, is an area drawing much attention by drinking water supply researchers and engineers in recent years. MHLW enforced the Standards on the Structure and Materials of Domestic Water Supply Equipment in 1997, and, since then, any product can be used freely for domestic water supply equipment so long as it meets the standards. Products are certified by their manufacturers or by a third party according to the standards. Therefore, some products, which do not meet the standards, are also sold in the market and used. For example, an o-ring containing polychlorinated naphthalene(PCN), whose

use is prohibited in Japan, and a bath water-heater with an improper backflow prevention device were found prevalently used, and, then, they were recalled. This fact shows that the improvement of quality and functions of domestic water supply equipment is an important issue in drinking water quality control.

Among others, lead problem is of great concern in Japan. Release of lead from lead service pipes and service fittings made of brass is a significant problem in drinking water quality control. Therefore, JWRC issued the Technical Guidelines on the Replacement of Lead Service Pipes in 2000 considering the importance of lead problem. The Japan Water Works Association(JWWA) also issued a report of the Special Committee on the Measures against Lead Problem in Drinking Water Supply in 2001 which stresses the necessity of coping with this problem by water supply systems.

On the other hand, MHLW has already announced to enforce a new drinking water quality standard on lead of not more than 0.01 mg/l from April 2003. However, a survey of JWRC has revealed that the total length of lead service pipes in Japan was still about 27,500 km in 1999, which was about 14,000 km less than that in 1991. As in many other countries, domestic water supply equipment is the property of individuals but not that of a water supply system. Therefore, it is difficult to replace lead service pipes with other pipes, and there is a high research need of developing lead control technologies in drinking water supply. The measures other than replacement being taken into account at present are pH control of drinking water and the application of a household water treatment unit with ion-exchange resin having a potential of lead removal.

CONCLUSIONS

The proper management of drinking water quality is the task of individual drinking water supply systems, and MHLW is responsible for administration for its control. Problems related to drinking water quality is always becoming complicated more and more. On the other hand, the deregulation of drinking water supply is inevitable even in Japan. Moreover, it is required to improve the level of drinking water supply services.

Under such a situation, the development of drinking water supply technologies for the purpose of ensuring its safety is becoming more important than before, and much attention to resource and energy saving, and environmental friendliness is needed in current and future researches in Japan.

10. Research agenda for Wastewater In Japan

Presenter

Dr. Masahiro Takahashi, Ministry Of Land,
Infrastructure And Transport

RESEARCH AGENDA FOR WASTEWATER IN JAPAN

Masahiro TAKAHASHI

ABSTRACT

The researches on wastewater system have been conducted many public and private sectors. National budget is allocated mainly to four institutions. Municipalities and universities also act important role. Current research topics are: risk, global climate change, practical nutrient removal, resource recovery, and the ecosystem. The first two topics are addressed elsewhere; this paper reviews the three remaining topics.

KEYWORDS

wastewater, nutrient removal, resource recovery, ecosystem

INTRODUCTION

Japan has been developing modern wastewater systems over the last few decades. Since Japan is a highly urbanized society, sewerage systems are considered to be the main wastewater systems. These systems receive large quantities of wastewater from both domestic and industrial activities. Consequently, sewage has a large impact on the water environment, material cycle and greenhouse gas exhausts in Japan. Many current research projects focus on these issues.

ORGANIZATION AND INSTITUTION FOR TECHNOLOGY DEVELOPMENT

Figure 1 illustrates the institutional structure. The four research institutions shown in the center of the figure are those to which national research budgets have been allocated. In recent years, the annual national research budget for wastewater systems has been approximately 900 million yen. Among the municipalities, which have implemented wastewater works, some large designated cities have their own technology development division. The MLIT organizes the Technology Development Council, which involves public institutions that promote joint research and information exchange. The private sector and universities are also active in this field. They carry out many joint research programs with the public sector.

The characteristics of those institutions that have been allocated funds from the national research budget are described as follows.

Masahiro TAKAHASHI: Research Coordinator for Water Quality Control, Water Quality Control Department, National Institute for Land and Infrastructure Management
Ministry of Land Infrastructure & Transport
Asahi 1, Tsukuba, Ibaraki, JAPAN 305-0804

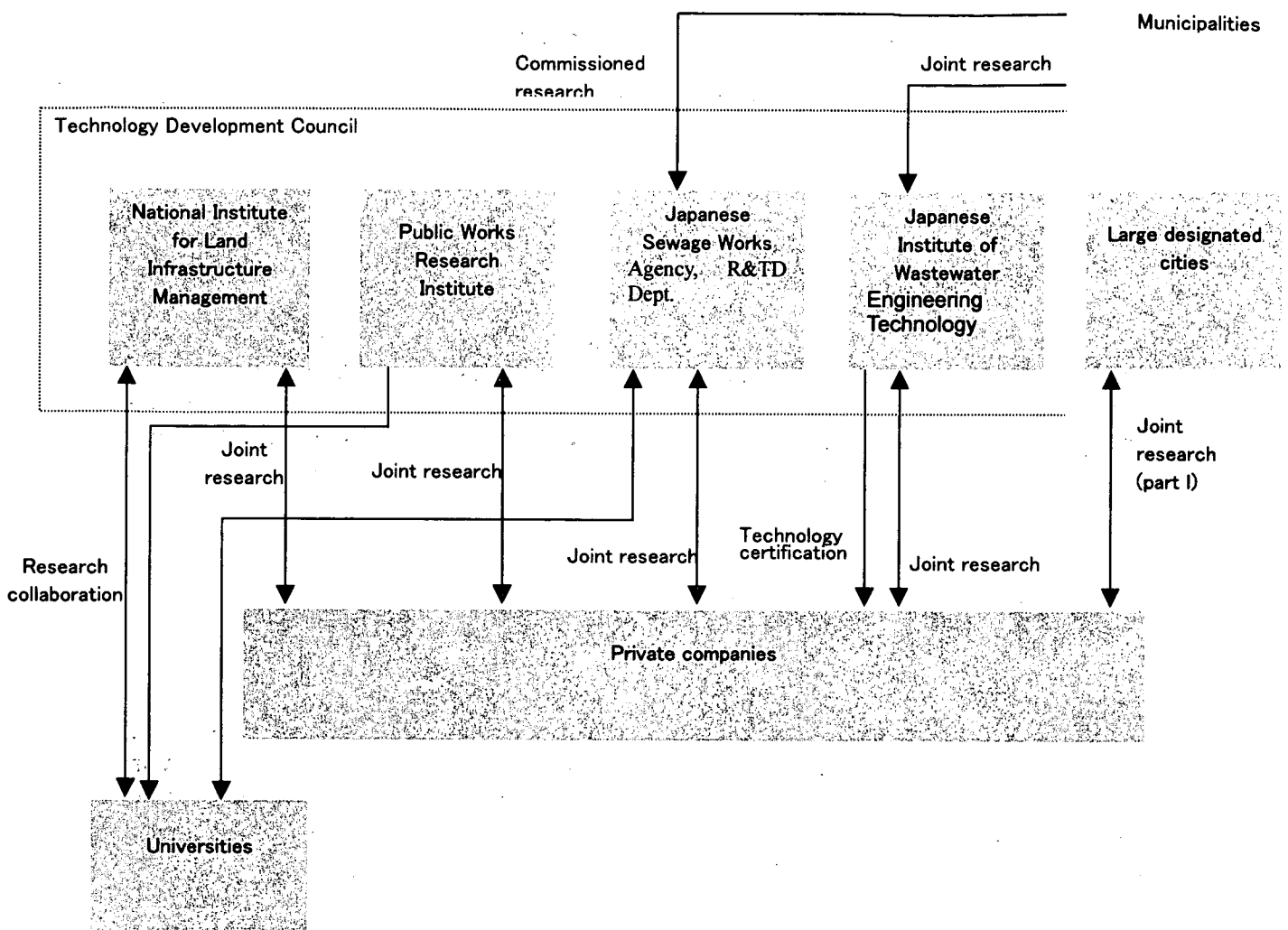

Figure 1. Institutional structure of sewerage in Japan ¹⁾

National Institute for Land and Infrastructure Management

The National Institute for Land and Infrastructure Management (NILIM) was established in 2001. It has a Water Quality Control Department, which mainly deals with wastewater systems. This institute has three main goals: to present a firm technological base for the national agenda which includes the establishment of laws or ordinances, establishing national standards and providing advice on ways of conducting national projects. For example, NILIM is supporting the establishment of the Ordinance for Structural Sewerage System Standards.

Public Works Research Institute

The Public Works Research Institute (PWRI) is an independent administrative institution that emerged from the national institution in 2001. It has a long history of more than 80 years. This institute conducts essential public research. These research studies include the development of new technology, basic research and multi media research of the kind that the national government itself need not conduct. For example, recent topics considered by PWRI include: endocrine disruptors in sewage, energy

recovery from municipal sludge, etc.

Japanese Sewerage Works Agency, R&TD Department

The Japanese Sewerage Works Agency (JSWA) was established in 1972 mainly by providing professional skills to municipalities constructing wastewater systems. The agency's R&TD Department supports the application and evaluation of wastewater technology, develops new technologies that meet the requirement of municipalities and basic research that will be the core technology of the future. For example, JSWA promotes the application of the original biological nutrient removal process, Multi Stage Step Feed Process throughout Japan.

Japanese Institute for Wastewater Engineering and Technology

The Japanese Institute for Wastewater Engineering and Technology (JIWET) is a non-profit foundation, established in 1992. Its aim is to promote the development of wastewater engineering and the application of this technology to sewage treatment works. They have helped the New Technology Promotion System that improves the municipalities' application of new technologies. The institute also conducts the Technology Evaluation System that examines and certifies private sector technology.

CONSTRUCTION AND OPERATION OF A NEW BIOLOGICAL NUTRIENT REMOVAL PROCESS

Nitrogen and phosphorous regulation is introduced into the main closed water bodies in Japan. Figure 2 shows special areas related to closed sea and designated lakes and reservoirs where nutrient control has been introduced. Water usage in these areas is significantly limited by eutrophication. Many existing wastewater treatment plants (WTP) in this area employ conventional secondary treatment processing. However, the regulation requires them to convert to an advanced wastewater treatment process. Nitrification and denitrification are the major processes involved in removing nitrogen and require a large reactor in order to maintain nitrifier. These plants are located in urbanized areas so there is little room available to expand the facilities for advanced treatment.

In the 1980s, a new technology was developed that overcame the limitations of space. Instead of expanding the reactor, immobilized microorganisms were placed into the reactor in order to enhance the biological treatment especially nitrification. Photo 1 shows the kinds of immobilized pellets used in Japan. Pellets are made from polyethylene glycol, polypropylene, sponge cubes, etc. The major advantage of this technology is that it can be applied to existing WTP with only minor modifications. As shown in Figure 3, screen sieves are necessary at the end of the reactor in order to retain the pellets within the reactor. Other sieves are required at the front-end of the reactor to prevent clogging of downstream sieves. Pellets are returned from the back-end of the reactor to the inlet by some device such as an airlift pump.

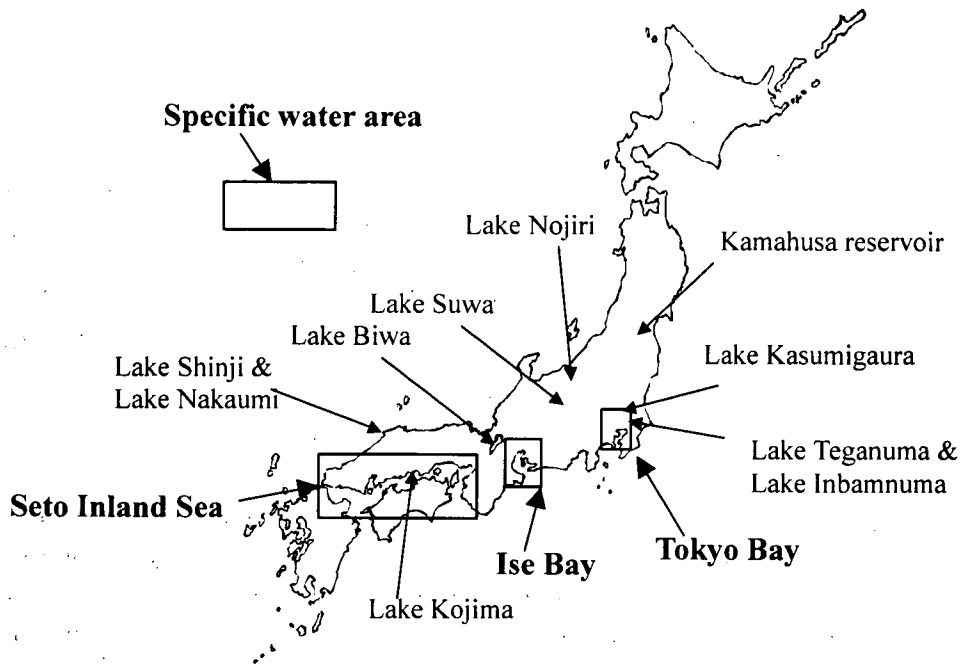
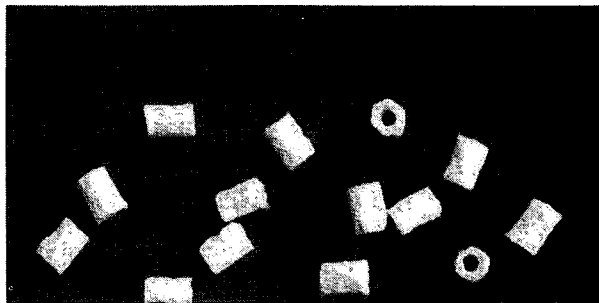
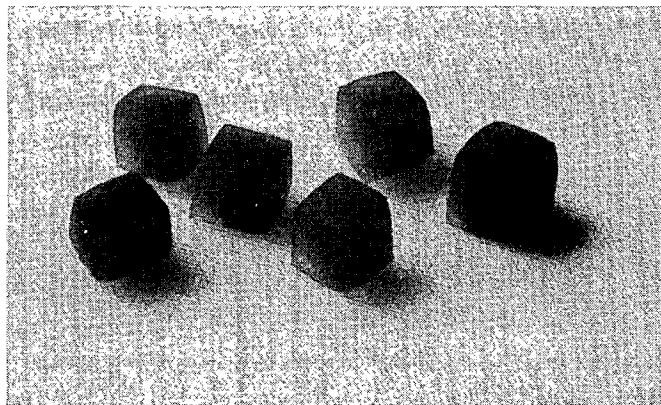

Figure 2. Specific water areas and designated lakes and reservoirs



a. Polypropylene pellets (PP)



b. Polyethylene glycol pellets (PEG)

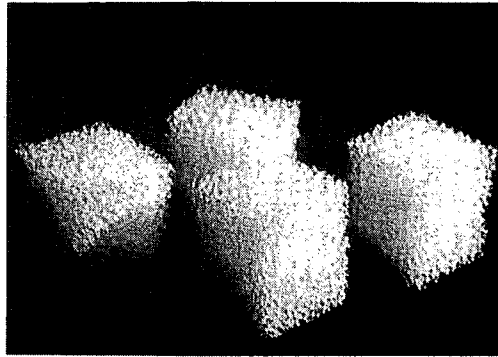

c. Sponge cubes (S)

Photo 1. Pellets used in Japan ²⁾

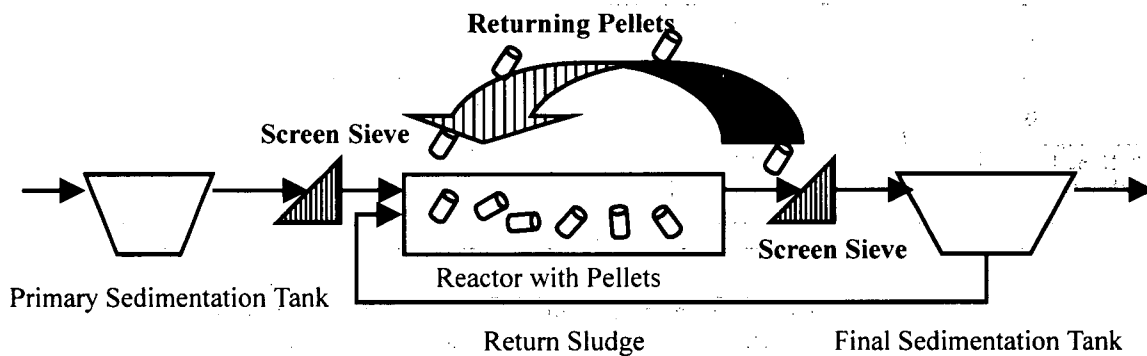

Figure 3. Using immobilized microorganisms in existing wastewater treatment plants

Fourteen WTPs used the immobilized microorganism process in Japan. The descriptions of these plants are listed in Table 1; their locations in Figure 4. The oldest WTP is in north Kyushu. It has a nine-year history. There are two WTPs in Osaka Konohana, and Takayama Miyagawa. They will be equipped with the immobilized microorganism process in the near future.

At the development stage it is expected that there will be problems with abrasion of pellets, leakage of pellets from the sieve, clogging of the sieve and over-concentration of pellets in the reactor. Improvement of pellets and sieves almost eliminates these problems. This process has become indispensable in terms of enhancing nutrient removal.

Table 1. Descriptions of those wastewater treatment plants using the immobilized microorganism process

No. from Figure 4	1	2	3	4	5	6	7
City	Takanezawa	Munakata	Ootsu	Miyakonojou	Okayama	Rikuzen-takada	kawasaki
WTP	Housyakuzi	Munakata	Ootsu	Seiryukan	Haga-sayama	Rikuzen-takada	asou
Year of opening	1993	1994	1995	1996	1997	1998	2000
Treatment process *	F+F	BNR +C	BNR	F+F	BNR +C	BNR	BNPR
Treatment capacity m ³ /day	2,100	11,300	11,800	7,200	2,680	2,800	13,000
Pellet type**	PP	PEG	PP	PP	PEG	PEG	PEG
Designed retention time in hours	4.5	7.3	5.2	3.8	7.4	13	8.2
Designed effluent quality							
BOD mg/l	5	14.2	10	20	12	10	14
T-N mg/l	-	6.3	10	-	18	10	10
T-P mg/l	-	0.2	-	-	1.2	-	0.5

No. from Figure 4	8	9	10	11	12	13	14
City	Akasi	Ichihara	Funabashi	Ginowan	Seki	Kawasaki.	kurasiki
WTP	Ookubo	Matsugashima	Nishiura	Ginowan	Sekishi	Iriezaki	mizusima
Year of opening	2001	2001	2001	1995	2000	2001	2002
Treatment process	BNR	BNR +C	BNR +C	AS With S	AS With S	BNPR	BNR
Treatment capacity m ³ /day	23,750	21,000	7,500	45,000	14,500	19,910	20,500
Pellet type	PP	PEG	PEG	S	S	PP	PEG
Designed retention time in hours	8	7.5	7.49	4.4	4.5	9.1	7.9
Designed effluent quality							
BOD mg/l	20	10	13	20	16	10	7
T-N mg/l	10	10	10	-	-	10	10
T-P mg/l	-	0.5	0.5	-	-	0.5	1.0

* F+F: Fluidized bed+filtration BNR+C: Biological nitrogen removal with coagulant
 BNR: Biological nitrogen removal AS with S: Activated sludge process with sponge cube
 BNPR: Biological nitrogen and phosphorous removal

** : see photo 1

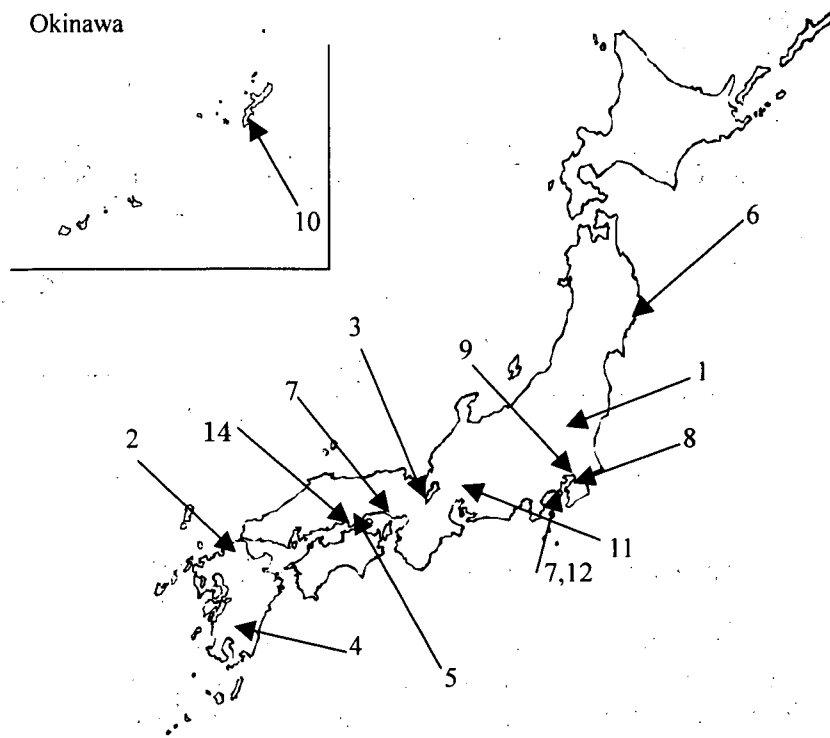

Figure 4. Location of immobilized microorganism process

RESOURCE RECOVERY FROM MUNICIPAL SLUDGE

Municipal sludge consists of water, organic and inorganic materials. Biogas and compost are common products from the organic material resulting from municipal sludge. Oil and char recovery has been tested for a long time.

There are promising resources in the inorganic material found in sludge; one of these is phosphorous. One European institute estimated that the world's phosphate rock supply would be consumed within 60 to 150 years. The USA increased the export price of phosphate rock six times in 1999 in order to maintain the national phosphorous resource.³⁾

Figure 5 illustrates the phosphate balance in Japan in 1993. 60,000 tons of phosphorous was released to the environment through the country's sewerage system. This amount will increase as the size of the population on reticulated sewerage systems increases.

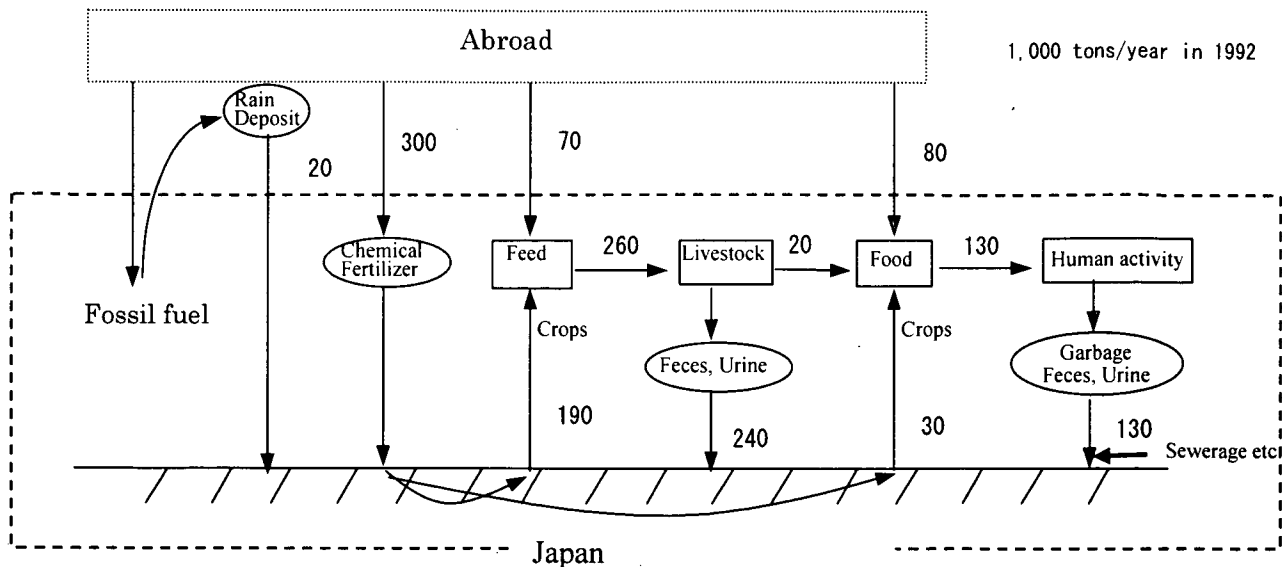

Figure 5. Phosphorous in Japan in 1993 ⁴⁾

The biological phosphorous removal process in mainstream wastewater treatment becomes common where regulation of phosphorous levels in effluent is introduced. Phosphorous release through the sludge treatment process generally causes low removal efficiency. On the other hand, the supernatant of the sludge treatment process contains large quantities of phosphorous, so it is worth recovering the phosphorous from it. The magnesium ammonium phosphate (MAP) and crystallization processes are being investigated and applied in Japan.

Most municipal sludge is incinerated in Japan. 1,432,000 DS-tons of incinerated ash was produced in 1999. The ash contains phosphorous (as shown in Figure 6) and is considered the same as phosphate rock.

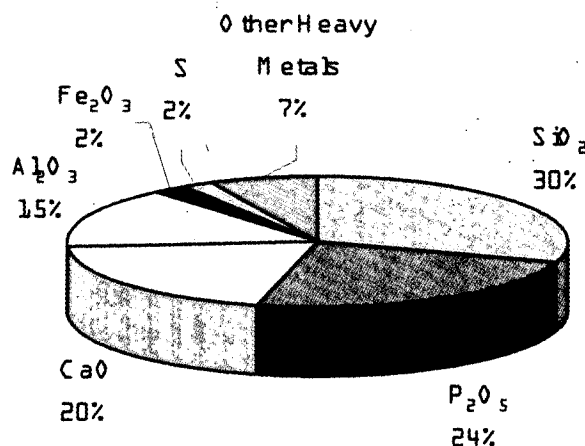

Figure 6. Composition of municipal sludge ash ⁵⁾

An investigation to recover pure white phosphorous from ash was conducted. The

recovery method, using a melting furnace in the reducing condition, is almost the same as that used for white phosphorous production from phosphate rock.

Another promising method is the production of slow-acting phosphate fertilizer. The ash is mixed with magnesium and calcium and melted in a reducing furnace. The mixture becomes light slug, heavy metal and gas in the furnace. The slug contains most of the phosphorous, magnesium and calcium. Heavy metals in the ash such as iron turn to metal. The gas contains volatile components such as Hg, Pb and Cd. This method is the same as fertilizer production from phosphate rock. The mass balance of each component is shown in Figure 7.

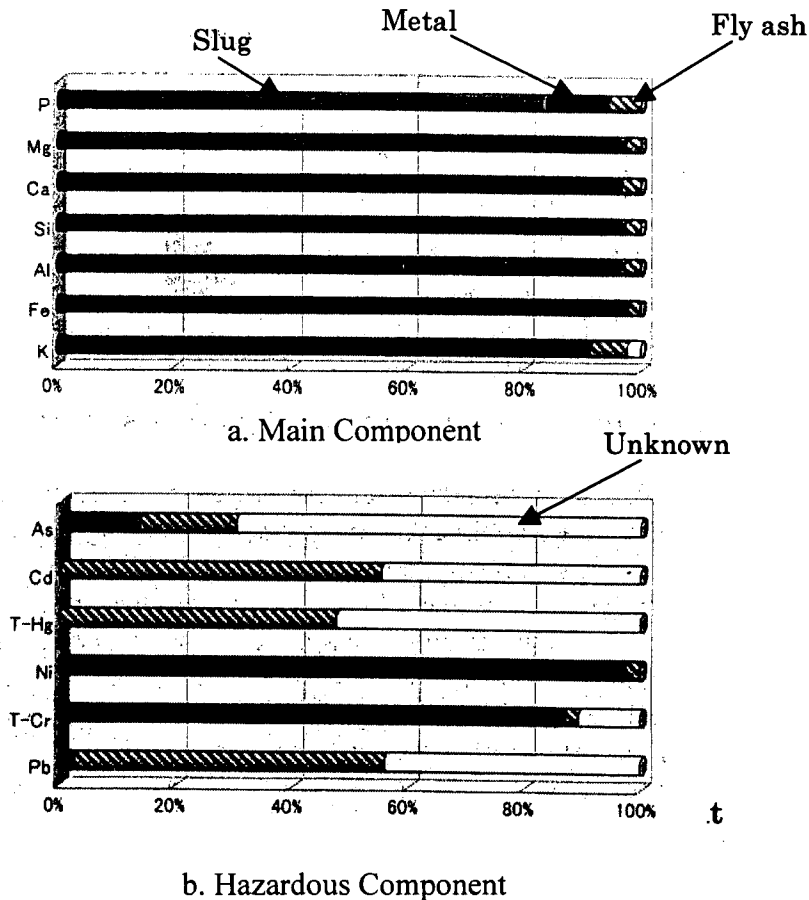

Figure 7. Mass balance of each component ⁵⁾

ECOLOGICAL EFFECTS OF EFFLUENT

Water resources are highly utilized around mega cities such as Tokyo, Osaka and Fukuoka. Cascade utilization of water is commonly observed. Effluent from the paddy fields goes back to the rivers. Effluent from WTPs is a major water resource in urban rivers. Figure 8 shows the percentage of effluent from WTPs in urban rivers in the Tokyo metropolitan area during dry weather. For example, the dry weather flow of Kanda River consists of 96% effluent. Ayu, a particular kind of migratory fish found in Japan, returned when WTPs applied nitrification and filtration processes to their water. Since the river structure is not suitable for these fish to spawn in, reproduction of ayu

has not yet been observed.

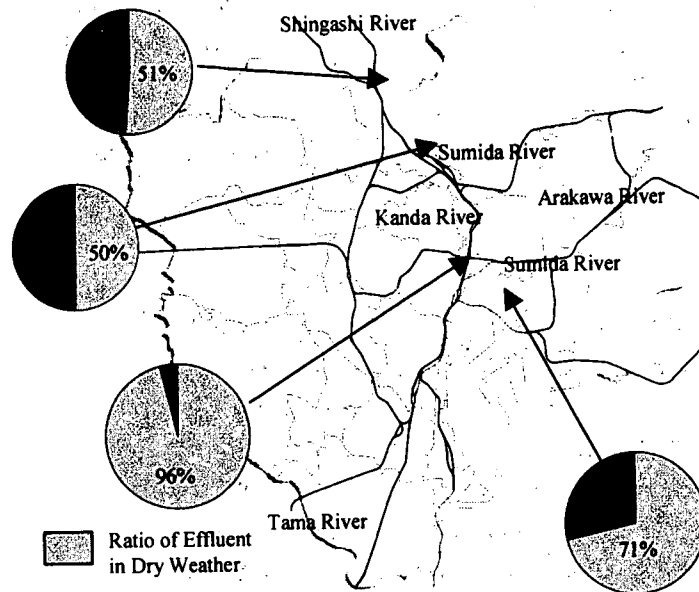

Figure 8. Percentage of effluent in urban Tokyo rivers in dry weather ⁴⁾

Many engineers and ecologists have intensively investigated the ecological effects of effluent. The MLIT published a guideline for enhancing eco-friendly sewerage systems. In this guideline, several examples of eco-friendly sewerage facilities are presented. In 2000, 53 ultraviolet ray facilities instead of chlorination plants were used to disinfect effluent, and the protection of ayu, dragonfly larvae, etc. was expected. Several WTP constructed *Biotops* using their effluent from the WTP sites to enhance their environmental education. Figure 9 shows a diagram of an eco-friendly sewerage system. However, as the ecological effects of these plans are not yet clear, it is important to obtain scientific evidence.

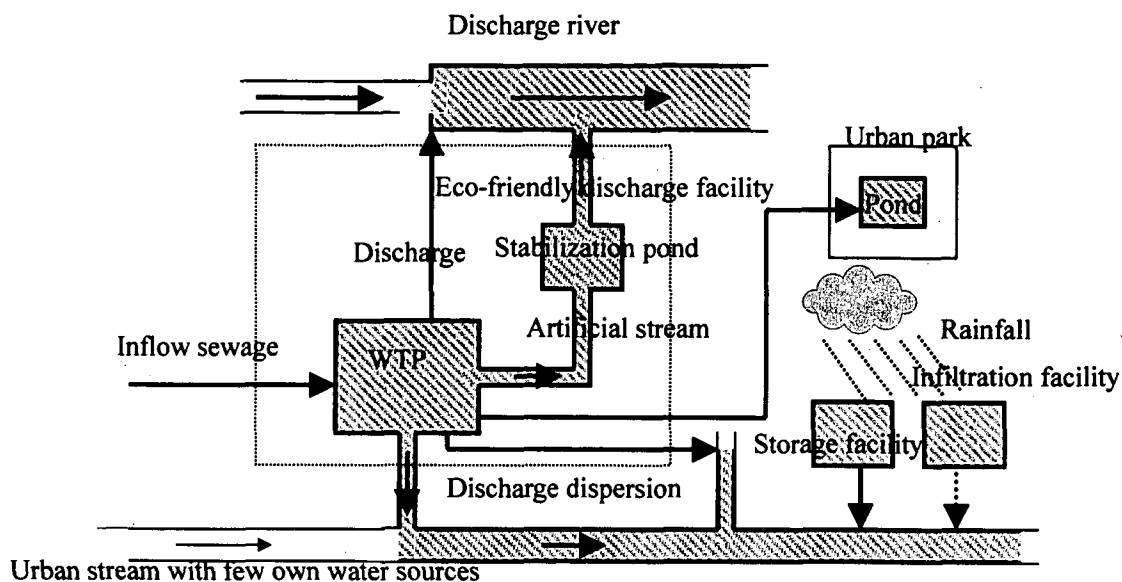

Figure 9. Eco-friendly sewerage system ⁶⁾

CONCLUSION

The Japanese economy and society have changed drastically over the last 10 years. Central and local governments have invested large quantities of money and manpower into constructing wastewater systems, and as a result the country's wastewater system has improved. It is now important to consider wider national and global concerns such as ecosystem protection.

Japan's population will decrease all over the country with the ratio of the elderly in rural areas likely to increase in the future. Consequently, the stock management of wastewater system will be a key issue in maintaining the wastewater and sludge systems. The next study will focus on the maintenance and rehabilitation of existing systems.

REFERENCES

- 1) Sato, K. "Sewage system technology development in Japan", Sewage Works in Japan, Japan Sewage Works Association, 2000
- 2) 担体利用処理法技術マニュアル（資料編）1994年度版，（財）下水道新技術推進機構
- 3) Jasinski, S. M. "Phosphate Rock", U.S. Geological Survey Mineral Yearbook, 2000
- 4) 下水道政策研究委員会報告，国土交通省都市・地域整備局下水道部，2001
- 5) 焼却灰からのリン資源化報告書，リン資源化研究会，2002
- 6) 生態系に優しい下水道の促進に向けた手引き書（案），国土交通省都市・地域整備局下水道部，2002

11. Awwa Research Foundation

Advancing the Science of Water

Presenter

James F. Manwaring, Awwa Research Foundation

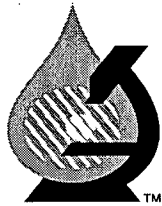

Awwa Research Foundation

Advancing the Science of Water

Awwa Research Foundation's Drinking Water Research Priorities

*Prepared for
Japan-US Conference on Water Supply and Water Resources Management
Tokyo, Japan
October 2002*

**James F. Manwaring
Executive Director
Awwa Research Foundation
6666 West Quincy Avenue
Denver, Colorado 80235
USA
<http://www.awwarf.com>**

The Awwa Research Foundation is a non-profit corporation dedicated to the implementation of a research effort to help drinking water utilities respond to regulatory requirements and traditional high-priority concerns of the industry. The Foundation serves as a planning and management function and awards research contracts to institutions such as water utilities, universities, and engineering firms. The funding for this research effort comes primarily from a subscription program. Through this program, approximately 950 water utilities voluntarily subscribe to the research program and make an annual payment proportionate to the volume of water the system delivers.

The mission of AwwaRF is to advance the science of water to improve the quality of life. The focus of AwwaRF's research is practical utility needs – technology to help water suppliers optimize operations and ensure customer satisfaction.

The Foundation's research agenda addresses a broad spectrum of water supply issues: resources, treatment and operations, distribution and storage, water quality and analysis, economics, and management. The ultimate purpose of the coordinated effort is to assist water suppliers in providing the highest possible quality of water, economically and reliably. True benefits result when utilities implement research findings. The general characteristics of the program are:

- Estimated 2002 AwwaRF research value: \$28 million
- Value of 2001 research agenda, including in-kind contributions; \$25 million
- Research funded through 2002 (with in-kind): \$258 million
- Number of research projects funded: 710
- Number of published reports: 425
- Number of ongoing projects: 285
- Number of research contractors: 250

Member utilities in the Foundation come from 48 of the United States, the District of Columbia, nine Canadian provinces, Australia, the Czech Republic, France, Great Britain, The Netherlands, and New Zealand. The population served by The Foundation's membership exceeds 175 million people.

Current Research Agenda

The Foundation's planning process is designed to produce a balanced research agenda that is directed toward four goal areas:

- **High Quality Water.** Provide research to help water utilities, through effective treatment, distribution system management and monitoring, delivery high quality water that ensures public health and safety and exceeds expectations for aesthetics. The Foundation intends to invest 45 percent of its total effort in this research area.
- **Efficient and Customer Responsive Organization.** Develop and optimize organizational systems and processes that help water utilities be efficient, effective and customer responsive organizations. The planning guideline for this area is 15 percent of the total research effort.
- **Infrastructure Reliability.** Provide research to help water utilities achieve and optimize infrastructure reliability to ensure a continuous, safe and uninterrupted supply to customers. The research investment target for infrastructure is 25 percent.
- **Environmental Leadership.** Provide research to help water utilities demonstrate environmental leadership through protection and sustainable use of water resources, development of alternative water sources and proper management of residuals. The planning guideline for the Foundation's investment in this area is 15 percent.

The value of the Foundation's 2002 research agenda is expected to be approximately \$28 million, a slight increase over the 2001 level. The principal philosophy underpinning AwwaRF's research effort is that public health protection is a fundamental objective.

To accomplish these goals, AwwaRF employs a number of operational strategies including the development of national and international partnerships. These cooperative ventures serve to avoid duplicative research and stretch existing resources by coordinating activities. The type of global network also serves to identify emerging drinking water issues. The Foundation's involvement in security related research is a perfect example of the subscribers' involvement in the planning process. Based upon the membership's concern, the Foundation was involved in security research prior to the September 11, 2001 attacks. This planning allowed the Foundation

to be in a very anticipatory and responsive position. The following paragraphs qualitatively describe the basis of the research priorities.

Security Related Research

Since September 11, the nation's drinking water utilities have been on a heightened state of alert to protect against the potential disruption of water service and biological and chemical contamination of drinking water supplies. Fortunately, before September 11, the water supply community was already at work to develop new methods and tools to protect water system facilities and consumers. This unique partnership was established in response to Presidential Decision Directive (PDD) 63 where EPA was identified as the lead federal agency for water supply and the Association of Metropolitan Water Agencies (AMWA) was appointed as the water sector's liaison.

Work has been progressing for a number of years, but more knowledge must be gained and disseminated on the characteristics of possible biological and chemical toxins, instantaneous and on-line probes to detect those contaminants, and remedial/preventive actions to neutralize those contaminants. Useful and practical techniques for evaluating and upgrading the security of water systems and new approaches for the design and operation of these systems, especially the drinking water distribution systems, are also critical needs. Understanding of the current threats and the development of tools and techniques to effectively evaluate the evolution of those threats must also be developed. Techniques for hardening water systems from cyber attack must be developed and installed. In short, practical research is absolutely essential to anticipate potential terrorist scenarios.

Over the last two years, AwwaRF, EPA and other water organizations have sponsored a number of research and development projects addressing water system security issues. These projects include tools for assessing vulnerabilities, preparations for response and recovery in the event of an attack, understanding the impact of potential biological and chemical agents, and training of water system personnel on security issues.

AwwaRF, in association with EPA, is funding a study to prepare a comprehensive list of security events and hoaxes at water utilities for the past ten years. These security events will also be analyzed relative to trends and common features, if any. Law enforcement or other agencies have not commonly tracked this information, and understanding of these events is critical information in properly understanding the design basis threat, related security upgrades, and possible prudent response and recovery operations for the utility.

EPA has started a project to develop a cyber vulnerability assessment component of the AwwaRF's vulnerability assessment tool. This module of the tool would allow water systems to conduct a risk-based self-assessment of cyber vulnerabilities at water facilities including process controls, SCADA, and vulnerabilities through Internet access.

EPA and the Center for Disease Control and Prevention (CDC) is developing a list of potential chemical and biological agents that could potentially be used to contaminate water systems. The report will address information on the nature of chemical and biological agents' impacts on water systems, and human health effects

Research on water infrastructure security is needed in a number of areas. . Details on both the short-term and long-term research needs are shown in Attachment #1. Water systems need to determine their potential vulnerabilities through assessment tools. The first generation of tools is emerging but advances in assessment methodologies are important. Water systems are also interested in new and innovative technologies and processes for protecting physical assets. Systems are concerned about preventing both contamination and disruption of water supplies.

As a result of advances in information technology and the necessity of improved efficiency, water systems have become increasingly automated. These advances have created vulnerabilities to cyber attacks.

Water systems are also looking at the needs for real-time monitoring and detection systems. Early detection systems may be essential in alerting water systems about potential biological, chemical and radiological contamination. Another area identified as critical to water systems'

preparation is the need for appropriate response and recovery plans. All large systems, and many smaller systems, have emergency response plans in place. However, these plans were developed to address mainly accidental spills and natural disasters such as floods, hurricanes, and earthquakes. Water systems need improved guidance and tools for updating these plans to address intentional acts including terrorist attacks.

High Quality Water

Over the past ten years, microbials and disinfection by-products (M/DBP) have become the centerpiece of the regulatory development efforts of the federal government and thus, by extension, a priority of AwwaRF. Significant uncertainties remain in assessing the health risks not only of the combined use of chlorine, but also the use of alternative disinfectants such as ozone, chlorine dioxide, and chloramines.

The development of a framework for providing simultaneous protection against pathogens and DBPs gives rise to three questions:

- What are the health risks caused by exposure to microbial pathogens?
- What are the health risks caused by exposure to disinfection by-products from different treatment processes?
- How can these risks be simultaneously controlled?

The ranking of M/DBP as one of the highest research priorities is based on several factors. First, the *Cryptosporidium* outbreak in Milwaukee in 1993, in which more than a hundred people died and many thousands of people became ill, served to underscore the risks of infectivity from harmful pathogens and the vulnerability of certain subpopulations to protozoans such as *Cryptosporidium*. Second, officials have now recognized that DBPs also pose a health threat. Third, because of the high uncertainty, the widespread human exposure to drinking water, the severity of the known effects from certain microbes, and the potentially high costs of further regulation of drinking water, the combined issue of microbial risks and disinfection by-products was assigned a high priority.

Current and recent past research in the microbial area has focused largely on the protozoan pathogens *Cryptosporidium parvum* and *Giardia lamblia*. Primary areas of research include

treatment effectiveness (inactivation and physical removal methods) and analytical methods for quantifying these pathogens and determining viability and infectivity. Other microbial research has included occurrence and treatment studies for pathogenic bacteria, viruses and algae, and development of microbial risk assessment tools for water utilities.

Although it has now been more than 20 years since the discovery of chloroform and other trihalomethanes in drinking water, there is still substantial controversy and significant knowledge gaps regarding the adverse health effect of DBPs. Epidemiological studies conducted on populations exposed to chlorinated water have generally been inconclusive. Likewise, epidemiological studies of reproductive effects have been similarly inconclusive. Because of the uncertainty, knowledge gaps, and disagreements regarding the health effects of DBPs, more research is needed.

Arsenic is another chemical for which regulations are proceeding without a complete scientific understanding of the treatability of this contaminant. Work is continuing on cost effective and efficient treatment systems for small communities and for waste disposal techniques.

Pesticides are a general class of chemical compounds that are the topic of several research projects. The issues surrounding this class of compounds which can be addressed by research are:

- occurrence and levels of occurrence;
- sources of contamination;
- best means of control;
- detection methodology; and
- health risk of single compounds and/or mixtures of compounds.

In the United States, pesticides, herbicides, and fungicides are applied at a rate of more than 1.1 billion pounds per year. The obvious concern is the potential contamination of the surface water and groundwater from the pesticides and their degradation products. National occurrence studies conducted to date have detected pesticides in drinking water but the levels rarely (less than one percent of the samples) exceeded drinking water guidelines.

Volatile and semi-volatile organic contaminants, such as fuel-additives, solvents, degreasers, and plasticizers, are becoming more of a drinking water issue; and issue that must be addressed by research. A major research effort has begun on MTBE, the gasoline additive, because of its widespread detection in both surface water and ground water. Other sources of contamination of this class of compounds include leaking storage tanks, landfills, and industrial discharges. Little is currently known about the health risk of these compounds and their effective control or treatment.

AwwaRF has spent a great deal of time and effort researching the compounds in drinking water that produce objectionable taste and odors. While such compounds do not constitute a direct health risk, their presence contributes to customer dissatisfaction and may reduce the consumer's confidence in the water quality. These compounds are regulated under a set of secondary standards which relate to the esthetic quality of the water. The sources of the taste and odor compounds are varied and may include algae in the source water, leaching of material from, or biological activity in, the distribution system, the use of disinfectants, and leaching from household plumbing. The causative agent for taste and odor episodes are very difficult to identify and the events may be short-lived and localized.

Infrastructure Reliability

It has been estimated that eighty-five percent of a water utility's assets are infrastructure – the treatment plants, storage tanks, and distribution system. A needs survey by AWWA has concluded that the near future rehabilitation and construction needs for the water industry are in the neighborhood of \$325 billion. It is also apparent that the water quality at the consumers' tap is strongly influenced by the utility's infrastructure. With so much at stake, it is no surprise that this area is one of the primary research topics for AwwaRF. AwwaRF has managed 107 applied infrastructure research projects valued at \$37 million since 1983. Half the research has been initiated in the past five years. The projects cover materials selection, emerging technologies, water quality management, structural integrity assessment, asset management, and operations and maintenance.

Improved management techniques have been promoted through Foundation-sponsored research on asset management. These include designing capital planning strategies, scheduling and prioritizing main replacement and repairs, and forecasting potential problems and their consequences. Cost savings and reduced inconvenience for customers are being realized through the development of new technologies for infrastructure repair and replacement. These include “no-dig” technologies, new relining methods, selecting suitable new pipe materials, and water main life extension.

Based upon several case studies, the average large utility has experienced benefits equal to \$1 million per year, from the application of the results of the infrastructure research. Research in technology and management reduces costs, increases productivity, protects public health, and enhances water quality. By ensuring a safe and reliable supply of water, infrastructure research is part of the foundation on which prosperity is built and sustained.

Efficient and Customer Responsive Organization

The change in the management and organizational philosophy within utilities will be a major factor in shaping the future of the U.S. water community. Water utilities are beginning to adopt “best practice strategies” to make themselves more efficient. Planned maintenance, work force flexibility, employee empowerment, continuous improvement, and customer interaction are only a few of the organizational concepts being employed in order to increase productivity and improve customer confidence. AwwaRF has an active research agenda on several management aspects of drinking water.

Planned maintenance has been shown to save money, up to a point. The data available from water utilities in the U.S. indicates that optimum maintenance is 70 to 80 percent planned with the remainder being reactive. Utilities are decreasing operational costs by providing a base staff to do the planned maintenance and importing staff to do the reactive maintenance. Total productive maintenance means that the entire staff is working on planned maintenance work and that specialists are imported only when needed. Studies have shown that combining reactive and planned maintenance improved productivity over 50 percent.

Likewise, workforce flexibility reduces maintenance waiting time, saves money and enhances morale among the employees. Operational costs are reduced dramatically when employees are trained to be multifunctional. To accommodate this type of flexibility, it is essential that the utility utilize some type of skill-based compensation.

It is evident that hierarchical organizational structures are rigid and slow to change to meet new responsibilities. New organizational strategies that focus on empowered employees; a team approach to problems and opportunities, and a streamlined structure can increase the competitive stature of water utilities.

AwwaRF's management research includes a diverse range of topics that together help utilities improve efficiency, obtain optimum water quality and improve system reliability. A large amount of research is devoted to process development and management, including conventional process optimization, advanced process testing and development, and energy management. Another area of significant study is process automation and optimization through the use of control systems and on-line monitoring.

Since the ultimate judge of the success and applicability of AwwaRF's research effort is the consumer, a portion of the research agenda is devoted to helping utilities interact with their customers. Projects in this area are designed to provide the utility manager with tools necessary to identify customer needs, encourage their consumers' participation in the decision processes operating in the utility and communicating with the public about important issues.

Customer satisfaction is quickly becoming the key driving force behind the modernization of water services. Progressive water utilities have adopted proactive customer relations to identify exactly what consumers want. Planning, development and utility direction are designed around those customer needs. This focus will lead to increasing customer confidence.

The primary research topics under this goal area are: (1) customer perception, communication and education, and (2) aesthetics issues (taste, odor and color), including causes and control.

Work has also been completed on managing rate structures and on the cost/benefit of supplemental services and products offered by water utilities.

Environmental Leadership

The water supply community is well aware of its position within the global environment. The future supply of dependable and safe drinking water is heavily dependent upon the quality of the watersheds and the operation of water utilities must have a minimal impact upon other uses of the environment. Research into watershed practices must proceed if optimal usage of this precious resource is going to be balanced among the numerous demands. Likewise, the by-products of water utility operations must be handled and disposed of in such a manner that will maintain, or even enhance, current environmental uses.

Recent work has focused on source water quality treatability impacts and associated cost to utilities. AwwaRF has sponsored an increasing amount of work in the past several years on wastewater reuse and reclamation. Recent studies have also been completed in the areas of residual management and minimization, water conservation, desalination, demand management, and control of invasive biota such as zebra mussels and non-native plant species.

2002 Research Direction

This year AwwaRF will fund approximately 75 new studies. Many of the new projects will address issues of current important to water utilities, such as security, monitoring techniques, filtration optimization, ultraviolet disinfection, microbial quality, membrane technology, distribution system water quality and reliability, watershed protection, management issues, and customer relations. Area of potential future concern will also be examined with studies on early warning systems, the value of water, and water recycling.

Attachment #2 contains a description of the Foundation's general research priorities and a listing of the specific projects being sponsored in 2002. The agenda is separated into the Foundation's four planning areas and includes the planned priorities for 2003.

Research Expenditures

In the United States, water utilities expend approximately 0.12 percent of their annual revenue on research. About one-half of that amount is for AwwaRF's centralized program and the remainder is for local issues and research concerns.

By contrast, the French water companies expend about 0.7 percent of their annual revenue on research, while the British companies have been estimated to use 0.5 percent. However, it should be noted that these are private water companies and some of this research investment is designed to produce products and processes that will provide a competitive advantage.

When compared to other industrial sectors, the water industry's expenditure on research is relatively small. The gas and electric utilities spend about one percent on research while the pharmaceutical industry expends almost nine percent.

Industry-sponsored research is absolutely essential to ensure a national balance between regulatory studies and operational research designed to address the practical issues of utility management. Governmental research has a strong emphasis on basic principals and regulatory concerns. Industry research is much more directed to process development and for providing operational tools and understanding.

Summary

Future water utilities will be shaped by several, interdependent factors that will include, but certainly will not be limited to, technology, regulation, competition, consolidation, political pressures, and consumer satisfaction. An active research program is essential to help plot the most effective and efficient path through the myriad of alternatives and to help integrate the current systems with the future technologies.

The exact result of all of these interconnected forces cannot be accurately predicted, but what is apparent is that future changes will be global. The water community has become a global entity where changes on one continent are felt on all of the other continents. One of AwwaRF's primary goals is to participate in an international effort to globalize research strategies on a

number of common issues. Research agencies must aggressively seek opportunities for cooperation and leveraging of resources. Partnerships not only extend limited resources but also serve to cross-pollinate different research cultures, technologies and approaches.

**AwwaRF
Research Priorities
Security Related Issues for Water Supply Systems
September 2002**

A substantial investment is needed for water infrastructure security research to address potential vulnerabilities at drinking water and wastewater systems. Research is needed to address three fundamental areas of vulnerabilities for water systems: physical vulnerabilities including disruption of flow and contamination by chemical, biological, or radiological agents; “cyber” vulnerabilities including process control equipment, Supervisory Control and Data Acquisitions (SCADA) systems, and other information systems; and vulnerabilities associated with interdependencies with other critical infrastructure sectors such as energy, telecommunications, transportation, and emergency services. Specific areas of research needed include: vulnerability assessment tools; technologies and processes for protecting physical assets, and information and process control systems; training, education, and awareness programs; information sharing tools; demonstration projects; real-time monitoring and detection systems; and response and recovery plans.

Immediate Priorities

The following projects were identified by an AwwaRF issue group in May 2002 as areas needing research attention over the next 2 to 3 years. Progress has already been made in responding to many of these priorities.

- **Utility-Relevant Information on Contaminants That Are Candidates for Purposeful Water Supply Contamination:** This is a phased project with the goal of ensuring that a central repository, accessible by drinking water utilities on a need-to-know basis, is created that provides accurate and actionable information on contaminants that could be used for purposeful contamination of drinking water.

- **Inventory and Assessment of Analytic Capabilities of Existing Monitoring Technologies for Use as Early Warning/Real-Time Systems Technologies:** This project would update and build on information from previous work on early/real-time warning system technologies. This project would include three primary steps: selection criteria for monitors, market assessment (what's out there and available), and assessment of the sample/capture/concentration/extraction methods of the various available technologies.
- **Extraction Methods for Early/Real-time Warning Systems for Biological Agents:** Screen 3 to 5 different water extraction methods for biological agent surrogates, and test the best method on actual bio-terrorism agents.
- **Standard Operating Procedures for Decontamination of Tainted Distribution Systems:** Provide utilities with practical, contaminant-specific best practices guidelines for how to decontaminate a distribution system and return it to safe use when contamination is known or suspected to exist in the distribution system.
- **Develop or Refine Models/Methods for Distribution System Monitoring to Detect Introduced Contaminants:** Develop (or upgrade/verify existing) models and methods for monitoring and projecting the fate and transport of potentially introduced contaminants in water distribution systems.
- **Lessons Learned from Initial Water Quality Vulnerability Assessments:** This project is designed to capture lessons learned and provide a forum for information exchange on vulnerability assessments conducted by the large drinking water utilities.
- **Vulnerability Assessment Template for Medium and Small Systems:** Develop an easy-to-use, intuitive, and scale-appropriate methodology for utility operators to characterize and assess the vulnerability of medium/small systems to a variety of terrorist (and other security-related) threats.
- **Primer on Security Best Management Practices:** This project will provide utility managers with a comprehensive, easy-to-use primer on "best practices" for security-related elements of utility operations.
- **Scenario Development and Training for Emergency Response Planning:** This project would build upon existing emergency response guidance and practices (AWWA Manual M19, USEPA *Emergency Response, Recovery & Remediation Actions to Man-Made and/or Technological Emergencies*, April 2002, etc.) to provide utilities with more security-oriented,

detailed, and specific materials with which to develop, test, and enhance their emergency response capabilities.

- **Security Implications of Innovative and “Unconventional” Water Provision Options:** To provide utilities with a security-oriented evaluation of alternative water supply provision options.
- **Guidance on Security-Related Utility Communication with the Public and Other Key Stakeholders:** This project would create a template or scripted set of pre-tested warnings and instructional messages to be communicated to the public; local, state, and federal emergency agencies; medical professionals; media; and other key stakeholders.
- **Assessment of Security Technologies:** This project would provide useful, needed information on commercially available security technologies and products so that utilities can make smart choices on what devices or systems to acquire/deploy to ensure the physical security of their facilities.

Long-Term Priorities

The following are some examples of the longer-term, multiple-phase research objectives for the water supply industry.

- **Miniature Liquid Chem Lab.** A prototype portable analysis unit for the analysis of biotoxins likely to be used by terrorists that mimics the capability of a large laboratory instrument in a low-cost, hand-held package has been developed. By further reducing the size of the unit, it could be made applicable as part of an early-warning monitoring system in municipal water supply systems. Expansion of the analytical capabilities of the instrument beyond biotoxins to other toxins such as arsenic, heavy metals and pesticides could also be accomplished.
- **Gas Chromatograph on a Silicon Chip.** A prototype miniature gas chromatograph and detector on a silicon chip has been developed. The unit is presently configured for gaseous chemical agent detection. However, its capabilities can be expanded as an analytical instrument for other toxic compounds. By expanding the capabilities of this system, it could be used as a low-cost real-time detector for volatile organic compounds as a part of an early warning system in a municipal water distribution system.

- **Nanoelectrode Analysis System.** A chip-based micro-electrode system that can be used for the analysis of various inorganic toxic species in water such as cyanide, arsenic, lead, and chromium that might be encountered in a municipal water supply is being developed. Additional work would concentrate on the development of low-cost, low maintenance electrode analysis systems that could be easily deployed in a large network of interconnected sensors within a water distribution system.
- **Simple Solid State Sensors.** Low-cost sensors such as chemiresistor sensors and surface acoustic wave sensors based on microchip technologies that can effectively serve as hydrocarbon or other chemical spill detectors have been developed. Additional research would be used to optimize the performance of these sensors and package them in such a way that they could be included in an early warning system for a municipal water supply system.
- **DNA-Chips.** Considerable progress has been made in the development of DNA-chips, which have been used to detect specific microbiological pathogens in water using genetic information. Such a capability is desirable since biological agents in a water supply system would occur alongside other no-hazardous organisms. The ability to differentiate between organisms type in real-time would be desirable from an early warning standpoint.
- **Systems Integration.** Many different types of sensors have been developed that can detect a chemical or a class of chemicals, but they are not integrated into one, knowledge based system. A system integrator is needed to miniaturize and integrate multiple sensors into one system.

AwwaRF's Research Priorities

The following paragraphs describe the Research Foundation's priorities for the four planning areas of the strategic plan. The general programmatic priorities are followed by a listing of the actual projects funded in 2002 in that goal area and the planned topics for next year.

High Quality Water

Mission: Provide research to help water utilities, through effective treatment, distribution system management, and monitoring, deliver high quality water that ensures public health and safety and exceeds expectations for aesthetics.

AREAS OF STRATEGIC EMPHASIS

Emerging Contaminants: The research strategy for emerging contaminants includes occurrence surveys, fate/transport studies and refinement of analytical detection methods (particularly for microbials). Emerging contaminants of concern include pharmaceuticals/endocrine disruptors, pathogens, nitrosamines, and industrial contaminants such as perchlorate. The results of our research, along with those from ongoing health effects work being done by others, will be used to support pragmatic water quality regulations and assist utilities in complying with future regulations.

On-Line Monitoring: Upcoming research is focusing on two primary areas: Reliability and optimal usage of existing (established) instruments, and development of new capabilities for early warning and improved operations. An eventual objective of this research area is to support regulatory approval of on-line monitoring data in lieu of fixed laboratory results for compliance purposes.

Advanced Treatment Technologies: Our work on non-conventional treatment technologies includes multi-year research agendas for membrane treatment and UV disinfection. Research on these technologies is relatively mature, having advanced from proof-of-concept and optimization studies to current and planned work on scale-up and integration into existing treatment systems. Key objectives of our work in this area are to promote regulatory confidence in and acceptance of these technologies for drinking water applications, and to provide utilities with practical tools for evaluating and implementing them.

2002 PROJECTS

- A Rapid Ammonia-Oxidizing Bacteria Measurement Method As An Early-Warning Indicator Of Nitrification Episodes
- Application Of DNA Microarray Technology To Simultaneously Detect And Genotype Isolates Of Escherichia coli O157:H7 And Cryptosporidium parvum In Water
- Application Of Hazard Analysis And Critical Control Points For Distribution System Protection
- Assessment Of Seasonal Chlorination Practices And Impacts To Chloraminating Utilities
- Characterization Of Particles In Filter Effluents
- Chloroacetamide Herbicides And Their Transformation Products In Drinking Water
- Development Of Distribution System Optimization Plans
- Dissolved Organic Nitrogen (DON) In Drinking Water And Reclaimed Waste Water
- Early Detection Of Cyanobacterial Toxin Using Genetic Methods
- Evaluating Alternative Data Gathering Methods For The 1999 Disinfection By-Product Field Study
- Evaluation Of MIEX Process Impacts On Treated Water Quality For A Range Of Raw Water Supplies
- Evaluation Of Pathogen Transport In Karst Flow Zones Of The Biscayne Aquifer Near The Northwest Well Field, Miami-Dade County, Florida
- Evaluation Of Triclosan Reactivity In Chlorinated And Monochloraminated Waters
- Geochemical Controls On Chromium Occurrence, Speciation, And Treatability In Groundwater
- High-Silica Zeolites For The Removal Of Polar Organic Contaminants From Drinking Water - Development Of A "Green" Adsorption/Regeneration System
- Impact Of Chlorine Dioxide On Transmission, Treatment, And Distribution System Performance
- Impact Of UV And UV Advanced Oxidation Processes On Toxicity Of Endocrine Disrupting Compounds In Water
- Integrating Membrane Treatment In Large Water Utilities; Investigating Treatment, Construction, And Cost
- Integrating UV Disinfection Into Existing Water Treatment Plants
- Linking Geographic Water Utility Data With Study Participant Residences Included From The National Birth Defects Prevention Study
- Methods For Real-Time Measurement Of THMs And HAAs In Distribution Systems

- Molecular Methods For Microsporidia Detection (MMMD)
- Occurrence Of Manganese In Drinking Water And Benefits Of Enhanced Manganese Control
- Optimization Of MF/UF Membrane Treatment For Direct And Clarified Water Filtration
- Optimizing Molecular Methods To Detect Human Caliciviruses In Environmental Samples
- Physical And Numerical Modeling Of Mixing In Water Storage Tanks
- Predictive Models For Water Quality In Distribution System
- Qualitative Procedures For Identifying Particulate Matter In Distribution Waters And At The Customer's Tap
- Removal Of Contrast Media
- Risk Based Prioritization Of Disinfection By-Products
- Standardization And Verification Of The MFI-UF To Measure Fouling Potential
- The Feasibility Of Allelochemicals As A Means To Control Toxic Cyanobacterial (Blue-Green Algae) Blooms In Water Bodies
- Treatability Of Algal Toxins Using Oxidation, Adsorption, And Membrane Technologies
- Treatment Of Elevated Organic Content Waters
- Use Of Membranes For Diffusion Of Ozone In Contactors
- Water Quality Implications Of Large-Scale Application Of Seawater Desalination
- Watershed Sources And Long-Term Variability Of Biodegradable Organic Matter And Natural Organic Matter As Precursors

2003 PRIORITIES

- DBPs (health effects, occurrence, monitoring, modeling and predicting formation, precursors)
- Organic nitrogen detection and control (Nitrosamines / NDMA)
- Distribution system water quality (biofilm control, pathogen intrusion, monitoring, operation/management)
- Organotin
- Manganese
- Pesticides
- Pharmaceuticals / Endocrine Disruptors / Personal Care Products
- Radionuclides
- VOCs
- Pathogens (viruses, bacteria, *Cryptosporidium*)
- On-line monitoring
- UV
- Membranes
- Taste and Odor

Efficient and Customer Responsive Organization

Mission: Develop and optimize organizational systems and processes that help water utilities be efficient, effective and customer responsive organizations.

AREAS OF STRATEGIC EMPHASIS

Strategic Management: Recent and upcoming management research focuses on developing new business strategies and applying modern business tools and techniques to the water utility business. This area of research will help utility managers develop business strategies that respond to the unique needs of their regional customer base. It will also help utilities assess the merits of modern private sector business practices for public and private utility business and tailor these for specific utility and customer needs.

Human Resources and Labor Management: With the recognition that we have an aging workforce and a changing utility business due to globalization, technological advancement, etc. the Foundation is funding a wide range of ongoing and upcoming projects on topics such as workforce planning, succession planning, labor relations, and business strategies that add value to human resource management. As the utility industry moves away from command and control management models, the Foundation is providing modern tools and strategies for planning and interacting with a modern and changing workforce.

Security and Crisis Management: The Foundation has been on the forefront of this recent and important trend in business and facility management. Beginning at the turn of this century, the Foundation was proactively responding with research to subscriber requests to ensure the protection of critical water utility infrastructure. This area of research also includes numerous ongoing and upcoming projects on disaster/emergency response, infrastructure design technology that optimizes security, infrastructure viability during natural and other disasters, security and disaster planning and response, and so forth.

Customer Perceptions and Communication. A considerable amount of ongoing research is focused on providing better understanding of customer perceptions and attitudes toward drinking water providers. A newer and related area of research is in the area of customer communication such as an improved understanding of how customers react to information and communicate with businesses. Customer communication research will help utilities develop methods and tools for reaching out to their customers and communicating on difficult topics such as water rates, drought related water restrictions, etc.

2002 PROJECTS

- Asset Management Planning And Reporting Options For Water Utilities
- Customer Acceptance Of Infrastructure Reliability
- Enhancement Of Water Treatment Plant Infrastructure Assessment Manager
- Extraction Methods For Early/Real-Time Warning Systems For Biological Agents

- Identifying, Understanding, And Addressing The Technical And Societal Issues Associated With Implementing Chloramination
- Impact Of CCRs And Emerging Issues Communications On Customers
- Implementing An Artificial Intelligence System For Real-Time Automatic Control Of A Full-Scale DAF Water Treatment Plant
- Inventory And Assess The Analytical Capabilities Of Existing Monitoring Technologies For Use As Early/Real-Time Warning Systems, Phase I
- Lessons Learned From Initial Water Utility Vulnerability Assessments
- Pipeline Net Validation
- Stakeholder Perceptions Of Utility Role In Environmental Leadership
- Strategic Planning And Organizational Development For Water Utilities
- Succession Planning For A Vital Workforce In The Information Age
- Utility-Relevant Information On Contaminants That Are Candidates For Purposeful Water Supply Contamination
- Vulnerability Assessment Template For Medium And Small Systems
- Water Utility Collaboration With The Health Community To Enhance Communications On Drinking Water Issues

2003 PRIORITIES

- Customer Care
- Emergency Management
- Workplace Health and Safety
- Information Technology
- Risk Mitigation
- Communication and Public Affairs
- Regional Consolidation
- Strategic Planning
- Workforce Planning

Infrastructure Reliability

Mission: Provide research to help water utilities achieve and optimize infrastructure reliability to ensure a continuous, safe and uninterrupted supply to customers.

AREAS OF STRATEGIC EMPHASIS

Non Destructive Assessment and Rehabilitation: Considerable emphasis has been placed in the drinking water industry in recent years on non destructive techniques for pipe condition assessment, rehabilitation and maintenance. This topic would continue to be emphasized in

future years as the water utility industry grapples with ways to optimize programs and resources for renewing distribution system infrastructure.

Long-term Materials Testing: Beginning in 2001, the Foundation developed a multi year research plan to commence with materials research and testing to assess the long term viability of many of the common and new materials used in water treatment infrastructure. Substantial emphasis will be given to buried infrastructure such as pipes, gaskets, valves, and so forth.

Management of Distribution System Water Quality: This topic area has been emphasized throughout the Foundations history and will continue to be featured in much of the upcoming research. Work in this area has shifted considerably to the assessment of whether there is a potential for contaminant intrusion into drinking water distribution systems and how to manage such events. Other water quality research focuses on the manner in which potentially harmful chemicals may change or react with other chemicals within the distribution system.

2002 PROJECTS

- Criteria For Valve Location And System Reliability To Optimize Continuity Of Water Supply
- Long Term Performance Prediction For Polyvinyl Chloride Pipe
- Multi-Utility Buried Pipes And Appurtenances Location Workshop
- Non-Disruptive Tools For Remaking Connections After Pipe Rehabilitation
- Performance Of Water Supply Systems In The February 28, 2001 Nisqually Earthquake
- Risk Management Of Large Water Transmission Mains
- Workshop On Non-Interruptive Condition Assessment Inspection Devices For Water Transmission Mains

2003 PRIORITIES

- Water Loss
- Distribution System Security
- Service Pipe Issues
- Life Expectancy of Pipe Materials and Linings
- Rehabilitation Prioritizing and Techniques
- Water Treatment Plant Infrastructure
- New Construction

Environmental Leadership

Mission: Provide research to help water utilities demonstrate environmental leadership through protection and sustainable use of water resources, development of alternative water sources and proper management of residuals.

AREAS OF STRATEGIC EMPHASIS

Sustainable Water Supply: There are few remaining untapped sources of high quality water in the world, and watershed management technology has shifted over time to water supply sustainability and source protection. The Foundation is funding and will continue with projects that look at management of sustainable supplies by looking at regional watershed and utility management models, economic models for water supply, water wheeling, source protection, and related topics.

Water Utility Leadership in Management of Environmental Resources. In response to subscriber requests, the Foundation recently changed the water supply research goal to emphasize utilities as leaders in environmental management. New Research in this area focuses on stakeholder perceptions of a utility's role in environmental leadership, regional leadership in the protection of sensitive species and habitat, and decision support tools that will help water utilities build a prominent and influential role within their supply regions.

2002 PROJECTS

- Advancement Of Early Warning System Technologies
- Decision Support System For Sustainable Water Supply Planning
- Development Of Effective Communication Tools Regarding Current Information On Reverse Osmosis/Nanofiltration(RO/NF) Concentrate Issues
- Innovative Treatment Alternatives To Minimize Residuals Containing Nitrate, Perchlorate, And Arsenic
- Monitoring Of BMPs To Determine Performance And Whole-Life Costs
- Producing New Potable Supplies from Seawater Desalination
- The Value Of Water In A Changing Economy
- Understanding Public Concerns And Developing Tools To Assist Local Officials In Planning Successful Potable Reuse Projects
- Use Of Water Treatment Residuals To Reduce Soil Phosphorus Loss And Protect Surface Water Quality: An Interregional Study

2003 PRIORITIES

- Global Climate Change
- Cooperative Water Quality Management with Agriculture Industry
- Alternative Water Sources/Regionalization
- Aquifer Storage and Recovery
- Early Warning Source Water Monitoring
- Environmental Management Systems
- Endangered Species Act Compliance
- Groundwater Vulnerability/Contamination
- Residuals/Waste Management
- TMDL
- Wet Weather Impacts
- Conservation

Ela\Jim 2002\Japan Oct 2002



Awwa Research Foundation

Advancing the Science of Water

Future Research Priorities
of the
U.S. Water Supply Community

James F. Manwaring
Executive Director

About AwwaRF



Mission:
*Advancing the science of water
to improve the quality of life*

- Centralized research program
- 1,000 subscribers
- Focus on Water Utility Needs
- Research Contracted
- Diverse Agenda

AwwaRF Security Research

- Biological and Chemical Contaminants
- Real-time Monitors
- Cyber Vulnerability
- Management Strategies

Seven Utility-Defining Macro-Trends

1. Infrastructure management will become key

- Quantify and articulate needs now
- Involve the community
- Explore private investment where needed
- Involve nontraditional stakeholders

Average Household Cost for Infrastructure

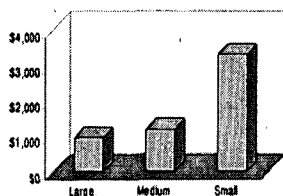

Small systems will be significantly impacted. Consumer rate shock is very likely in many communities. Rate resistance may foster political upheaval.

Figure 9.3: Average Cost Per Household to Meet Water System's 20-Year Infrastructure Need (Total Need in January '95 Dollars)
(Source: USEPA, 1997)

Seven Utility-Defining Macro-Trends

2. Environmental regs will become more stringent

- Explore new water delivery approach
- Develop partnerships with stakeholders
- Develop options to make Ag water available
- Convene stakeholders to address national environmental policy "disconnects"

Water Diversion and the Environment

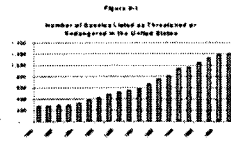

Source: Division of Endangered Species, U.S. Fish and Wildlife Service, May 2000.

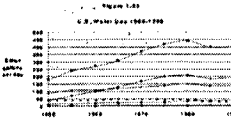

Source: USGS, Estimated Use of Water in the U.S. In 1990, Trends in Water Use

Endangered species issues will become increasingly complex.

Population pressure (in the absence of conservation) will increase the need for additional water supplies.

Consumer Confidence

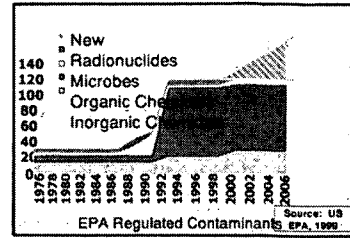

Regulations will continue to expand. Analytical methods have outstripped our ability to understand health risks. "Safe" water is a relative term. Bottled water & point of use device sales continue to rise. Regulators & utilities continue to debate the cost/benefit of drinking water regulations. Consumers are in the middle.

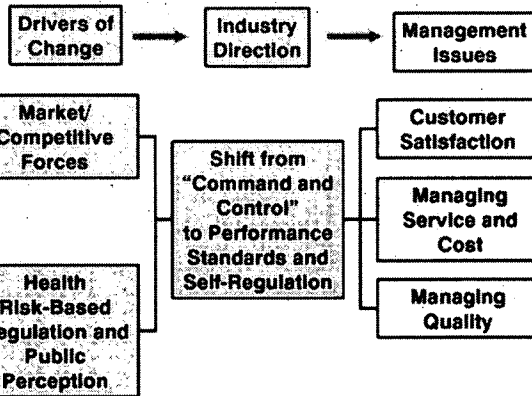

Seven Utility-Defining Macro-Trends

3. Water utilities will continue to restructure

- Remove structural impediments to efficiency and satisfying customer demands
- Maintain oversight of water in public sector but accommodate private sector
- Increase regional water management
- Encourage water markets

Seven Utility-Defining Macro-Trends

3. Water utilities will continue to restructure (continued)

- Establish national water policy on Ag, demand management & pop/growth management
- Investigate consolidation into multiservice utilities
- Establish clear service delivery accountability in restructured utilities
- Consider changes in federal law and other policies to attract capital

Service Alternatives

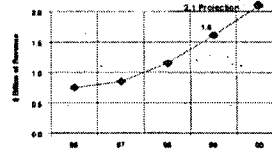

US Water/Wastewater Outsourcing Revenue (Contract Operations) (Source: PWFinancing, March 2000)

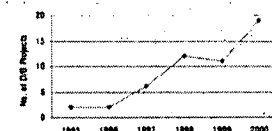

D/B Water and Wastewater Projects (includes studies or plans in process; Source: PWFinancing, February 2000)

Outsourcing & design/build contracts have grown and are expected to continue to. The rate of growth will likely be driven by local economic and political conditions.

Seven Utility-Defining Macro-Trends

5. The work environment will be transformed

- Establish a workforce planning and development program
- Develop aggressive program to recruit/retain staff
- Offer competitive compensation packages and creative incentives to keep best and brightest
- Share info with employees
- Work for stable board/management relationships

Human Resources

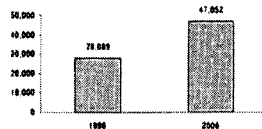

Growing Demand for Engineers (Source: Bureau of Labor Statistics, 1999-2008)

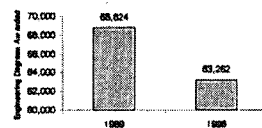

Decline of Engineering Degrees Awarded to Science and Engineering Graduates (Source: Benaimon, Helen Frank, January/February 2000)

Finding technical staff will be increasingly difficult and utilities will increasingly compete for talent.

Adopting Best Practices Strategies Makes You Competitive

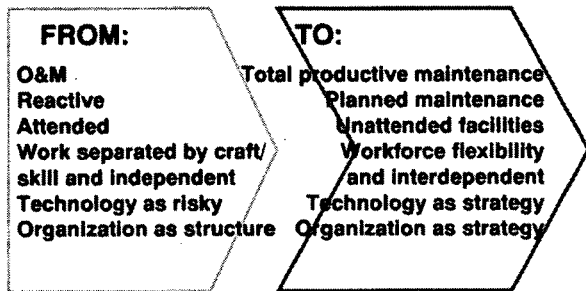

Cross-Training Increases Productivity by 20 Percent

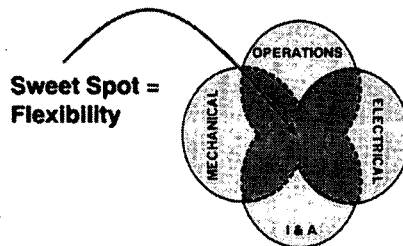

Seven Utility-Defining Macro-Trends

6. Application of technology will grow

- Install automation to reduce labor, save chemicals and energy
- Integrate information systems
- Use internet to improve purchasing, research, training, customer service. Operate like a business.
- Apply technology after optimizing and implementing best work practices
- Commit to R&D to foster innovation, new technologies and health risk understanding

Technology

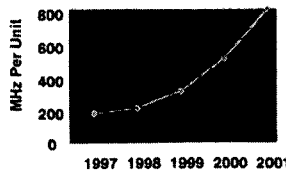

Computing power will continue to rise and the cost drop dramatically over time.

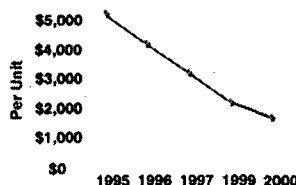

Technology

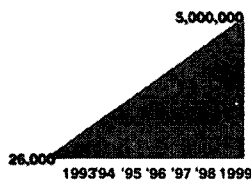

Internet use will continue to exhibit exponential growth.

In 1993, there were 26,000 Web sites in use. In 1999, there were more than 5 million.

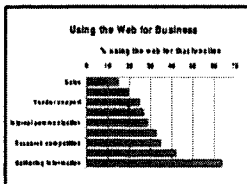

Leveraging the Web for conducting utility business and customer communication is in its infancy.

Technology

The improving economics of desalting may help alleviate water shortages.

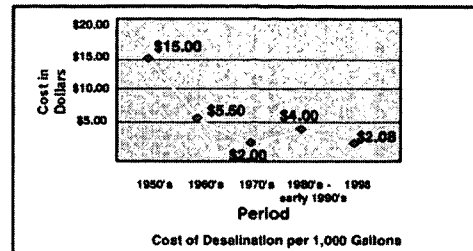

Seven Utility-Defining Macro-Trends

7. Total watershed management will be essential

- Develop watershed-based resource management approaches
- Create demand management/conservation/reuse programs using rate based incentives to manage water supply demands
- Evaluate multiquality tiered potable delivery and treatment systems

Global Water Industry Technology Development Position

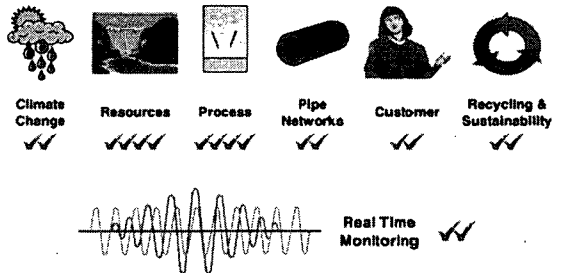

Global Water Research Coalition

- International network of water research organizations
- Water supply, sanitation, wastewater treatment and water reuse

The GWRC Founding Members

- Awwa RF
- CRC WQT
- Kiwa
- CIRSEE (Ondeo)
- STOWA
- TZW
- UK WIR
- Anjou Recherche (Vivendi Water)
- WERF
- WRC - SA
- WRF
- WSAA

Collectively these 12 research programs represent 500 M people and over \$100 M annual research budget.
- Coordination of research programs at a (inter)national level
- Managing the knowledge cycle

12. QA / QC for The Monitoring of Drinking Water Quality

Presenter

Dr. Masanori ANDO, National Institute of Health Science

CURRENT AND NEAR FUTURE ON QUALITY ASSURANCE AND QUALITY CONTROL FOR DRINKING WATER IN JAPAN

Masanori Ando

Director

Division of Environmental Chemistry and Exposure Assessment

National Institute of Health Sciences

Ministry of Health, Labor and Welfare

1. INTRODUCTION

After World War II, the development of the water supply system has been quite rapid, and the population served has become 96.1 percent in 1997. Quality assurance (QA) is a set of operating principles that, if strictly followed during sample collection and analysis, will produce data of known and defensible quality. That is, the accuracy of the analytical result can be stated with a high level of confidence. Included in quality assurance are quality control and quality assessment. This paper reviews the protocols of QA and QC from actual condition of systems of monitoring and inspection laboratory for drinking water quality in Japan.

2. CLASSIFICATION OF WATER WORKS

2.1. Classification of Water Supply

Japan has four kinds of water works defined by the Water Works Law, i.e. large scale water supply system, small scale water supply system, private water supply system, and bulk water supply system.

(1) large scale water supply:

population to be served of more than 5,000

(2) small scale water supply:

population to be served of 101 to 5,000

(3) private water supply:

for private use for dormitory, sanatorium, etc. and populations to be served of more than 100

(4) Bulk water supply:

to supply purified water to large and small scale water supply systems
Most of these are managed by municipal governments, i.e. city, town or

village. And some prefectural governments also manage bulk water supply system of large scale public water supply system.

2.2. Scale of Water Works Bodies

Number of each scale of water works bodies are shown in figure 1. Approximately 96 % of Japanese population is presently served by the public water supply, most of which belongs to a small-scale water supply with the exception of big cities. But, about 15,300 water supply are operating now and about 85% of them are small-scale water works. And then, the number of small-scale public water systems that serve less than 5,000 people was 9,549 in fiscal year 2000. Half of these small-scale water supply systems are generally using ground waters as water source. Thirty percent of them are using surface waters treated by rapid and slow sand filtration processes. However, technical and operational problems begin to increase due to deterioration of the surface water quality. Furthermore, it is becoming difficult for these small-scale systems to secure skillful and educated staffs, which raises new questions in water management in Japan. And then, the middle-scale water works (about 1610) such as served >5,000-<100,000 people was similar condition.

Figure 1 The Number of Water Supply Systems

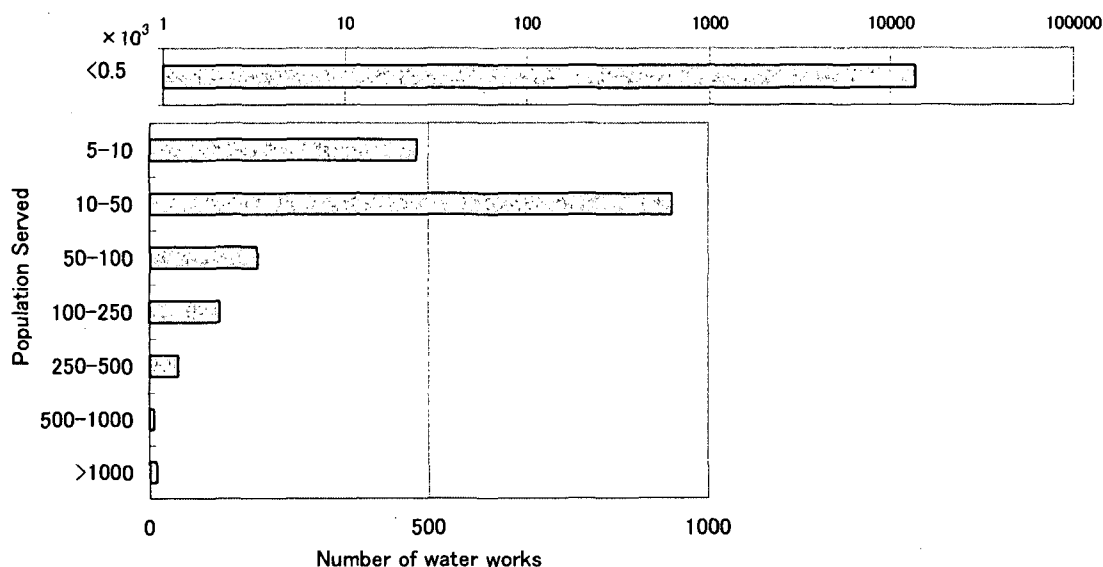

Recently, the number of large public water supply systems has increased little by little, however on the contrary the number of small public supply systems has decreased as a result of integration and so on (Figure 2).

Figure 2 Shift in the number of water supply systems.

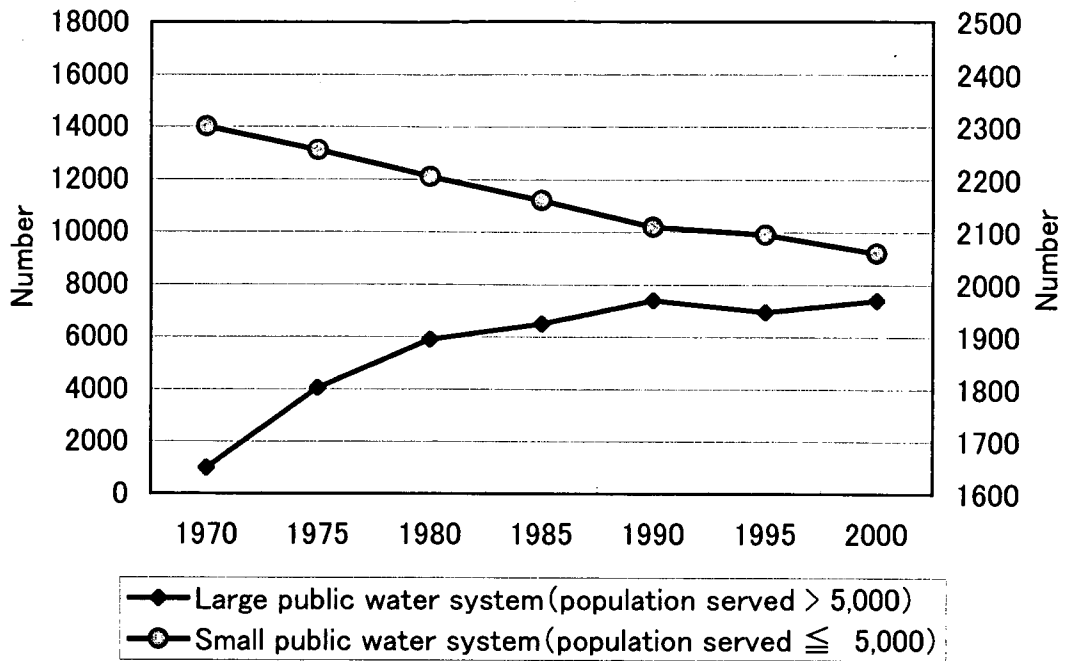

2.3. Population served of Classified Water Supply

Most of the people served by large-scale water supply, and the people served by small-scale water supply of less than 5,000 is only 0.4 % (Figure 3). The population served by middle-scale water supply (32 %) is smaller than those of large-scale water supply (68 %).

Figure 3 Population served on each scale of water supply.

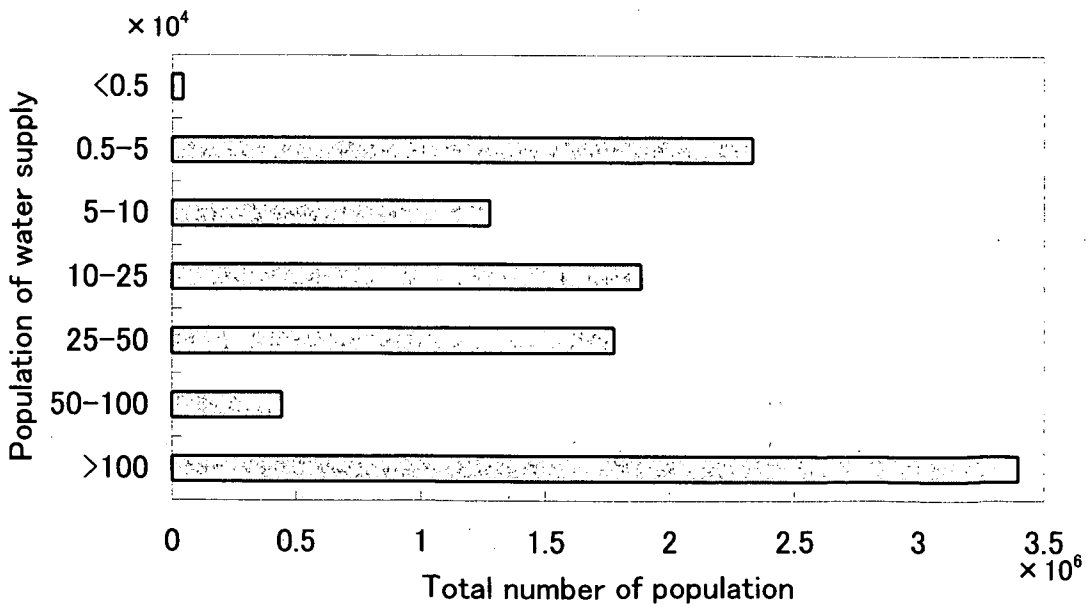

The population served by small-scale public supply systems has decreased every year, whereas the population served by large public water supply systems has increased every year (Figure 4).

Figure 4 Total population served on Large and Small-scale water supply system.

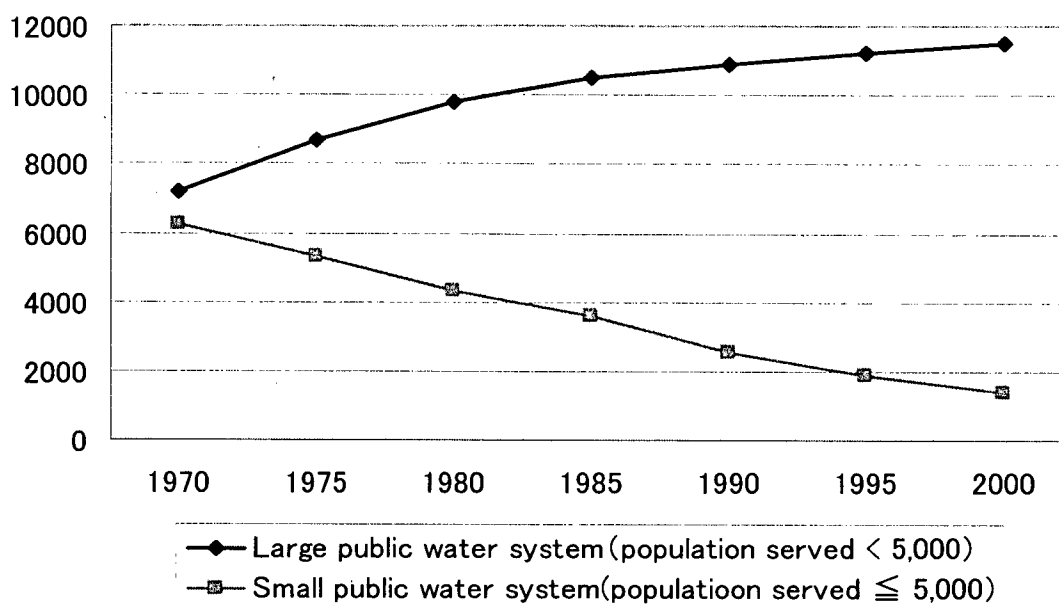

3. Quality Standards of Drinking Water

3.1. Quality Standards

Water works in Japan are required under the Quality Standards of Drinking Water based on the Water Works Law.

Due to the expanded use of various chemicals, those chemicals were detected in public water bodies. Moreover the revision of drinking water quality standards and guidelines on those chemicals by some international and overseas organization such as WHO was being carried out successively. Considering these facts, the quality standards (46 items) were revised by MHLW in Dec. 1992.

3.2. Items Relating to the Comfortability and Items Relating to Monitoring

In addition to the revision of the Quality Standards of Drinking Water, the MHW established the guideline values for two categories of items relating to the comfortability”(13 items) and relating to monitoring”(26 items). The “Items Relating to Monitoring” relate to human health.

These items contain 11 kinds of pesticides and 5 kinds of disinfection by-products. As for these items, the MHLW expects that each waterworks are informed of the result of the systematic surveillance by a representative waterworks appointed for every major river and use the result properly. However, analytical technique of these chemicals should be required to have staffs and instruments to high quality.

4. MONITORING

4.1. Large-scale Water Works

By the Water Works Law, every waterworks are obliged to carry out regular and ad-hoc monitoring of tap water quality, and to install the instruments necessary for water quality monitoring (TABLE-1). As a rule, themselves of water works should do the monitoring. This is due to the reason that, if so, a prompt action can be taken in case of a water quality accident. Many large waterworks can do the examination in their own laboratories with professional staffs.

TABLE-1 PERIODIC AND AD-HOC EXAMINATION OF WATER QUALITY

Examination	Examination Items	Number of Examination
Examination prior to starting water supply	46 Items residual chlorine	1 time 1 time / 1 day
Periodic examination Of water quality	Color, turbidity residual chlorine 46 Items	1 time / 1 month
Ad-hoc examination Of water quality	Necessary Items	When supplied water is apt not to meet water quality standards

4.2. Assistance to Small and Middle-Scale Water Works

However, many small and some middle-scale waterworks have similar problems: with shortage of budget, instruments, staffs, level of knowledge. Most of the small-scale and some middle-scale water works can not do whole analytical items. And then, analytical items of high level at these water works have entrusted public health or designated private laboratories authorized by the MHLW may do the examination for them.

5. VARIOUS KINDS OF MONITORING LABORATORIES

5.1. Number and Contracted Population of Monitoring Laboratories

There are four kinds of monitoring laboratories such as captive laboratory of Water works, Cooperative laboratory of Water Works, Public center of local government and designated private laboratory based on law for monitoring in supply water. Current total number of monitoring laboratories is 336 and half of total laboratory is designated private laboratories.

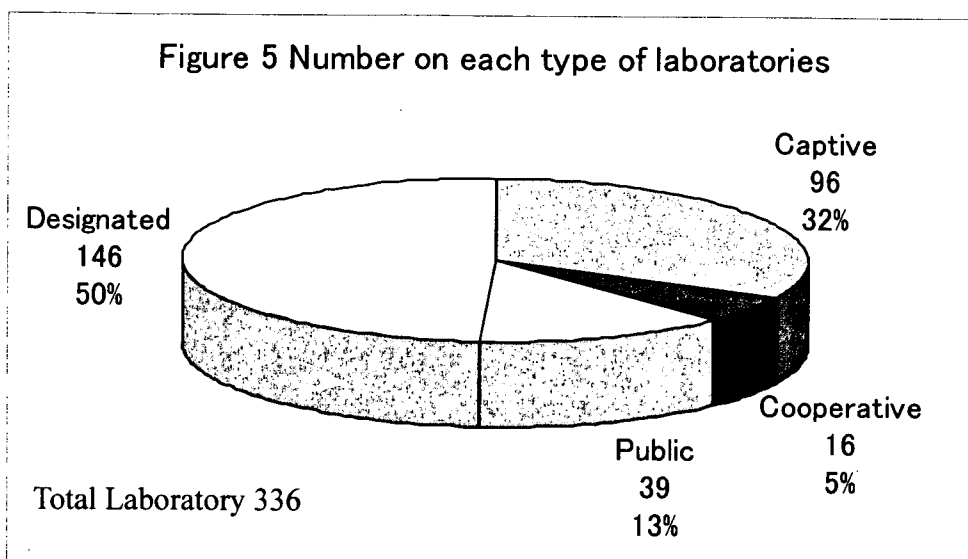
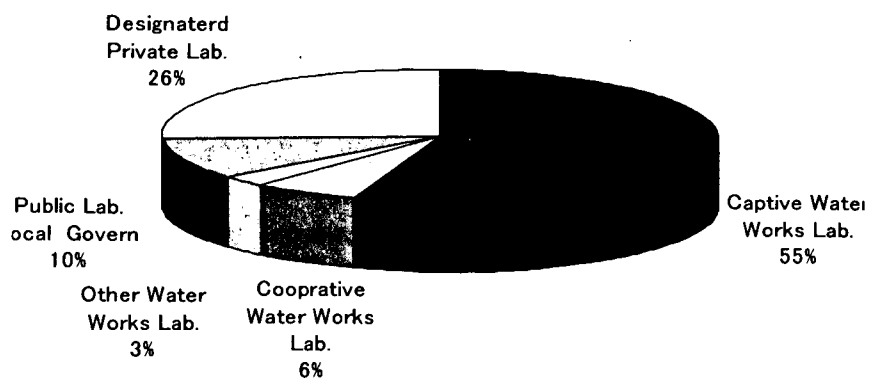

Figure 6 Rate of population supplied on various kinds of inspection laboratories population



However, the population included designated private laboratories is much smaller than captive laboratories to be operated large-scale water works (Figure.6).

5.2. Circumstances of Monitoring Laboratories and Various kinds Water Works

As mentioned above, the monitoring laboratories differ according to scale of water works (Table 3). Many large waterworks, especially the largest water works group of population to be served of more than 100,000 can do the examination in their own laboratories with professional staffs. However, middle or small-scale water works do not have equipment and staff. Therefore, these water works are entrusting to the contracted designated private laboratories to analyze continuously.

TABLE-3 EACH TYPE OF LABORATORIES AND WATER WORKS

	Total Water Works Lab.	Captive W.Ws Lab.	Cooperative W.Ws Lab.	Other W.Ws Lab.	Public Lab. local govern.	Designated Private Lab.
Large	1964	249 (13%)	157 (8%)	138 (7%)	670 (34%)	1290 (66%)
Bulk	110	57 (52%)	6 (5%)	7 (6%)	9 (8%)	22 (20%)
Small	9370	0	268 (2.7%)	323 (5%)	1147 (12%)	6073 (62%)
Private	3837	0	0	36 (1%)	1240 (30%)	1604 (69%)
Total	15281	306 (2%)	426 (3%)	683 (5%)	3066 (23%)	8989 (66%)

6. ANALYTICAL METHODS

In the revised standards, several methods including methods for simultaneous analysis of many items are introduced as the official methods (Table-2). And considering the improvement of analytical technology, new trace analytical methods such as inductively coupled plasma spectrometry (ICP, ICP-MS) for elements analysis, purge trap/gas chromatograph-mass spectrometry (PT/GC-MS), head space/gas chromatograph-mass spectrometry (HS/GC-MS) and purge trap/gas chromatography (PT/GC) for chlori-

nated compounds analysis, etc. are adopted. Most of the detection limits in the revised standards are 10-20% of the standard values.

TABLE-2 ANALYTICAL METHODS OF QUALITY STANDARDS OF DRINKING WATER

Item	Methods
Cadmium	AAS, ICP, ICP/MS
Mercury	AAS
Selenium	AAS, ICP/MS
Lead	AAS, ICP, ICP/MS
Arsenic	AAS, ICP/MS
Chromium(VI)	AAS, ICP, ICP/MS
Cyanide	AS
Nitrate and Nitrite Nitrogen	IC, AS
Fluorine	IC, AS
Carbon Tetrachloride	PT/GC-MS, PT/GC
1,2-Dichloroethane	PT/GC-MS
1,1-Dichloroethylene	PT/GC-MS, HS/GC-MS, PT/GC
Dichloromethane	PT/GC-MS, HS/GC-MS, PT/GC
Cis-1,2-Dichloroethylene	PT/GC-MS, HS/GC-MS, PT/GC
Tetrachloroethylene	PT/GC-MS, HS/GC-MS, PT/GC
1,1,2-Trichloroethane	PT/GC-MS, PT/GC
Trichloroethylene	PT/GC-MS, HS/GC-MS, PT/GC
Benzene	PT/GC-MS, HS/GC-MS, PT/GC
Chloroform	PT/GC-MS, HS/GC-MS, PT/GC
Dibromochloromethane	PT/GC-MS, HS/GC-MS, PT/GC
Bromodichloromethane	PT/GC-MS, HS/GC-MS, PT/GC
Bromoform	PT/GC-MS, HS/GC-MS, PT/GC
1,3-Dichloropropene	PT/GC-MS
Simazine	SPE/GC-MS, SPE/GC
Thiram	SPE/HPLC
Thiobencarb	SPE/GC-MS, SPE/GC
Zinc	AAS, ICP, ICP/MS
Iron	AAS, ICP, ICP/MS, AS
Copper	AAS, ICP, ICP/MS
Sodium	AAS, ICP, ICP/MS
Manganese	AAS, ICP, ICP/MS
Chloride Ions	IC, Titration
Calcium, Magnesium, etc.(Hardness)	Titration, IC, ICP/MS
Methylene Blue Activated Substance	AS
1,1,1-Trichloroethane	PT/GC-MS, HS/GC-MS, PT/GC
Phenols	AS
Organic Substances (Consumption of Potassium Permanganate)	Titration

Abbreviations:

AAS	Atomic Absorption Spectrophotometry
AS	Absorption Spectrophotometry
GC	Gas Chromatography
HS	Head Space
HPLC	High Performance Liquid Chromatography
IC	Ion Chromatography
ICP	Inductively Coupled Plasma Spectrometry
MS	Mass Spectrometry

PT Purge Trap

SPE Solid-Phase Extraction

7. HOW TO SECURE RELIABILITY OF THE ACCURACY ON LABORATORY

As mentioned above, these methods are required high analytical technology and monitoring laboratories used with these methods are included with many levels to analytical techniques. And then, the each data measured from the monitoring laboratories are involved much unreliability. The quality standards prescribed water works law should be require that analyses for determining compliance with the standard values be conducted by a laboratory approved by the primary regulating authority. This requirement will be evolved into a formal certification program for drinking water laboratories as described in the MHLW publication "Manual for the Certification of Laboratories Analyzing Drinking Water,

7.1. Problems on Various Kinds of Monitoring Laboratories

The internal and external quality control for monitoring laboratories should be done by themselves. The systematization of quality control had only recently been developed and started for designated laboratories. The quality control comes into effect to the designated private laboratories contracting small-scale water works in response to require to MHLW. But, the internal and external quality control to the large monitoring laboratories was not obligated to be required by MHLW. As previously explained, in spite of largest captive or cooperative water works laboratories have big population,

Figure 7 DIFFERENCE OF ANALYTICAL SYSTEM IN LARGE AND SMALL-SCALE WATER WORKS

SUPPLY WATER

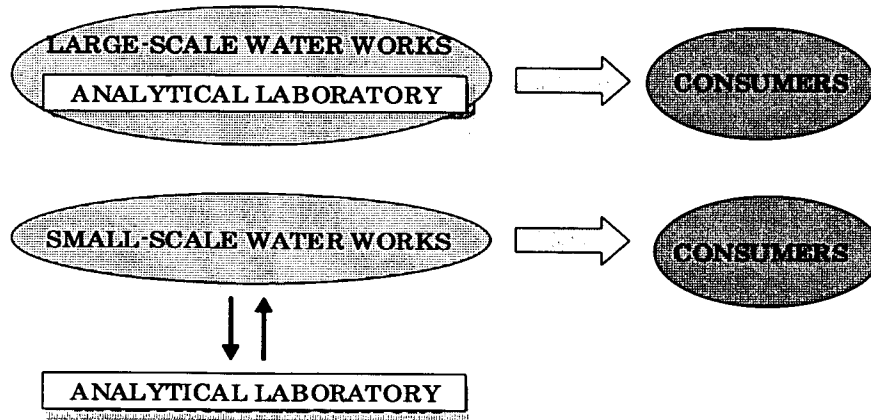

laboratories of these water works do not carried out quality control (Fig. 7).

7.2. Quality Control

Quality control measures have always been part of analytical work. The basic principle is that measurements should be as comprehensible, as plausible and as accurate as possible, or at least interpretable.

Today, such monitoring works are carried out quality control for only designated private monitoring laboratories.

7.3. Quality Assurance

For a laboratory to produce consistently reliable data, it must implement an appropriate program of quality assurance procedures. Analytical methods must be validated as fit for their purpose before use in the laboratory. If possible, validation should be achieved by means of collaborative trials that conform to a recognized protocol. These methods must be fully documented, laboratory staff must be trained in their use, and control charts should be established to ensure that the procedures are under statistical control. If possible, all reported data should be traceable to reliable and well-documented reference materials, preferably certified reference materials. When certified reference materials are not available, traceability should be established to a definitive method. Accreditation of the laboratory by the appropriate national accreditation scheme, which

should in turn conform to accepted standards, indicates that the laboratory is applying sound quality assurance principles. ISO 17025 (Guide 25) describes the general guidelines for assessing a testing laboratory's technical competence. Although proficiency tests can be executed independently, accreditation assessments now use the information produced by proficiency tests.

Participation in proficiency testing schemes provides laboratories with an objective means of assessing and demonstrating the reliability of the data they are producing.

Although various protocols for the design and operation of proficiency testing schemes have been produced to cover particular areas of analytical chemistry, a harmonized protocol that would be universally acceptable is needed for the organization of proficiency testing schemes.

7.6. Problems of Analytical Quality Assurance Systems

The use and documentation of quality assurance procedures are indispensable for tests, in order to ensure that test results are really valuable, comprehensible, and justifiable. However, methods of quality assurance should be regarded realistically, as even with accredited or GLP-conforming tests, errors or inconsistencies can occur. The written formulation of quality assurance criteria by a laboratory is still not a sufficient guarantee of the quality of work. In case of doubt the customer can only instruct the company to use several different tests on an identical sample. In addition identical samples from the same source can be tested several times under different designation.

The use of and adherence to quality assurance procedures usually increases the costs of tests. Whether this leads to better quality and more comprehensible and more comparable results depends on the individual case and the reliability of the test.

Quality assurance is the definitive program for laboratory operation that specifies the measures required to produce defensible data of known precision and accuracy. The laboratory quality system will consist of a QA manual, written procedures, work instructions, and records. The manual should include a quality policy that defines the statistical level of confidence used to express the precision and bias of data, as well as the method detection limits. Quality systems, which include QA policies and all quality

control processes, must be in place to document and ensure the quality of analytical data produced by the laboratory and to demonstrated the competence of the laboratory.

Quality systems are essential for any laboratory seeking accreditation under state of federal laboratory certification programs.

**13. Occurrence, Treatment and Costs of Complying
with the Arsenic Rule in El Paso, Texas**

Presenter

Mr. Edmund G. Archuleta, El Paso Water Utilities

GFH Specifics and Results

GFH Specifics

- Must be shipped moist because media will not rewet easily.
- Around 4% by weight as fines that must be washed out.
- Cost: \$2.50 to \$4.00 per lb
- Design for 5 min. Empty Bed Contact Time, 5 to 7 gpm/sf
- Need 35,000 lbs of media for each 1 MGD capacity

GFH Specifics and Results Adsorption Systems Operation: Series

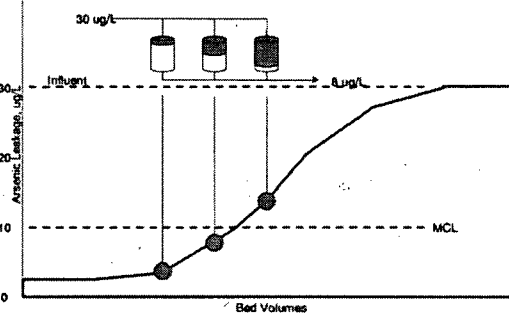

GFH Specifics and Results Process Schematic

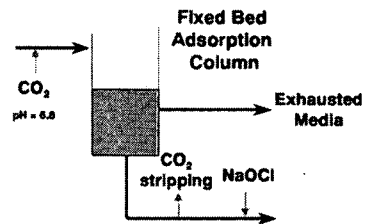

GFH Specifics and Results Pilot Data

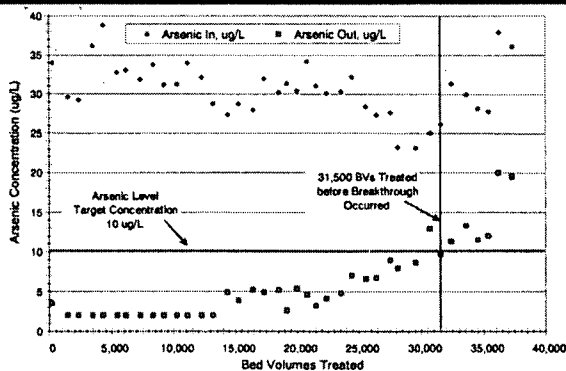

C/MF Specifics and Results

Occurrence, Treatment and Costs of Complying with the Arsenic Rule in El Paso, Texas

Japan-US Governmental Conference on Water Quality Management and Wastewater Control
Tokyo, Japan October 22, 2002

Ed Archuleta, P.E.
General Manager
El Paso Water Utilities
Public Service Board



Background

Arsenic Rule

- Became effective February 22, 2002
- Compliance by January 23, 2006
- Arsenic Maximum Contaminant Level set at 10 mg/L (0.01 mg/L)
- Compliance based on quarterly running average, single sample can not exceed 40 mg/L.

Background

Arsenic in El Paso

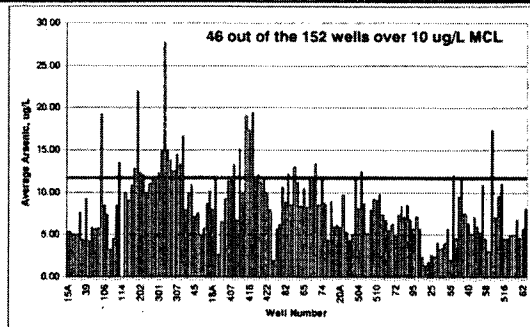

Background

Arsenic Removal Technologies Considered

- Screened Out Technologies
 - Ion Exchange
 - Activated Alumina or Regenerable Media
 - Membranes
 - Softening Water Treatment Plant
- Potentially Appropriate Technologies
 - Coagulation/ Microfiltration
 - Fixed Bed Adsorption Technologies

Background

Arsenic Pilot Testing

- Pilot testing required to evaluate arsenic removal technologies
 - Fixed Bed Adsorption
 - Granular Ferric Hydroxide (GFH)
 - Coagulation / Microfiltration (C/MF)
 - Ferric chloride coagulation
 - Pall microfiltration

C/MF Specifics and Results Chemistry of Iron Oxyhydroxide and Arsenic

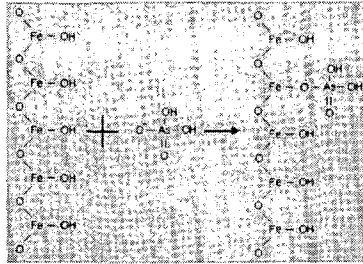

- Particle Size 2 to 10 microns
- As must be in +5 oxidation state rather than +3

C/MF Specifics and Results Ferric Hydroxide Speciation

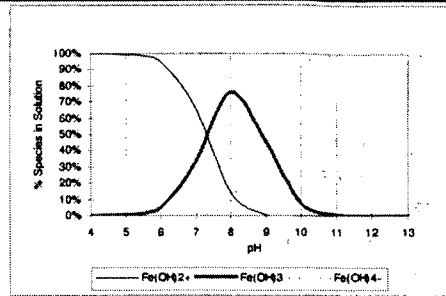

- pH needs to be less than 7.3 for arsenic removal

C/MF Specifics and Results FeCl₃ Dose Vs Arsenic Removal

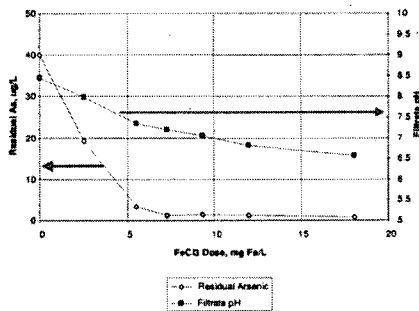

C/MF Specifics and Results Process Schematic

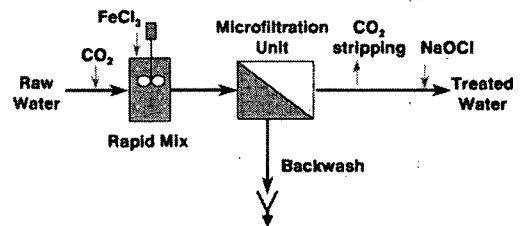

C/MF Specifics and Results Pall Microfilter

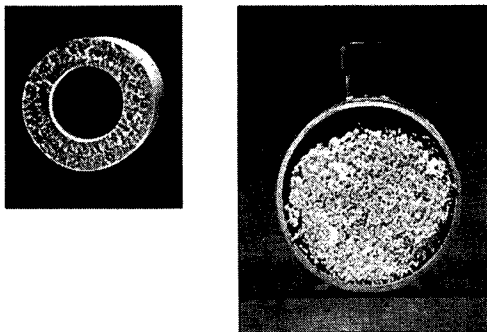

C/MF Specifics and Results Pilot As Data

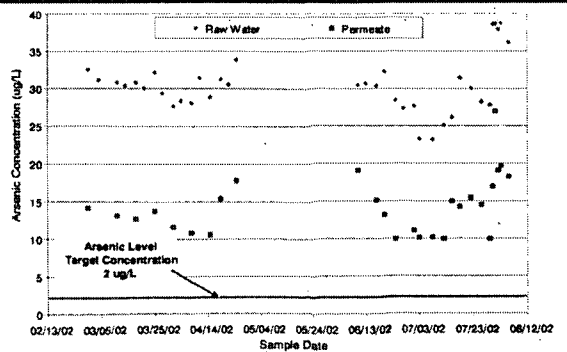

C/MF Specifics and Results Arsenic Removal

- Did not achieve 2 mg/L target
- Initially, As believed to be in +5 oxidation state
- Further As speciation indicated approximately 10 mg/L in +3 form
- Requires addition of oxidant prior to filtration to oxidize As(III) to As(V)

Economic Analysis

Economic Analysis Assumptions

- 90 gfd flux for MF
- 31,500 Bed Volumes for GFH
- 10 mg/L ferric chloride dose
- 40 mg/L CO₂ dose

Media Vs. Filtration Systems

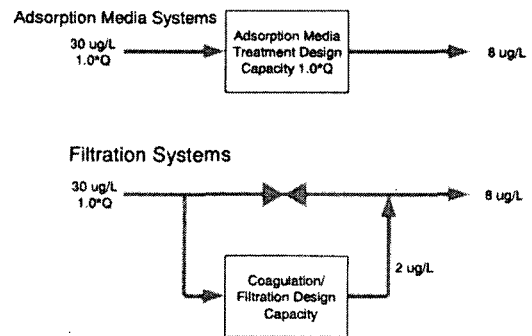

Conclusions

- GFH breakthrough at 31,500 BVs
 - Removed As(III) and As(V)
 - Potential for greater bed volumes with prechlorination and significant offline time
- C/MF flux rate of 90 gfd
 - Did not achieve 2 mg/L As target
 - Due to presence of 10 mg/L of As(III)
 - Will prechlorinate to convert As(III) to As(V)
- Facilities will proceed with GFH
 - Easier to start/stop operation than C/MF
 - Potential for media costs to decrease and be competitive with C/MF
 - Less maintenance is huge advantage for multiple facilities

Selected Treatment Approaches

Well Head Granular Ferric Hydroxide

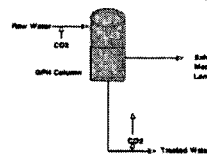

Canutillo Conventional Treatment

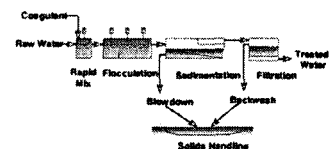

EPWU Arsenic Compliance Program

Well Field	Average Arsenic Concentration (ppb)	Type of Treatment	Treatment Capacity (mgd)	Estimated Capital Cost
Canutillo	13.6	Centralized Conventional	30	\$50,000,000
Northeast	12.8	Four GFH Well Head	Approximately 1.5 to 2.2, each	\$11,500,000
Lower Valley	12	Three GFH Well Head	Approximately 1, each	\$3,500,000
Eastwood	11	Centralized GFH	4.2	\$4,300,000
Cielo Vista	10.4	Two GFH Well Head	0.75, each	\$3,600,000
Montana McRae	7	None	None	\$0
Airport	5.85	None	None	\$0
Shearman	5.2	None	None	\$0
Newsa	2.9	None	None	\$0
TOTAL		Eleven Facilities	47	\$74,900,000

Canutillo WTP - \$50 million
Eastside GFH - \$24.9 million

Questions ?

14. SAFE DRINKING WATER

- Lessons to be Learned from Recent Large-scale Waterborne
Outbreaks of *Cryptosporidium* -

Presenter

Dr. Takuro ENDO, National Institute of Infectious Diseases

SAFE DRINKING WATER

- Lessons to be Learned from Recent Large-scale Waterborne Outbreaks of *Cryptosporidium* -

Takuro ENDO

Director, Department of Parasitology,
National Institute of Infectious Diseases, Tokyo, Japan

INTRODUCTION

The greatest impact of water pollution on human health comes through drinking water acting as an important vehicle for the transmission of a large variety of infectious diseases. The sanitary engineering for safe drinking water has long relied on the application of the multi-barrier concept. These barriers, at the present time, are basically designed to have multiple removal capabilities through the treatment chains to give backup system to support continuous operation. While water treatment technology can successfully process poor quality source waters to produce potable water that meet accepted drinking water standards, there is still serious concern that the barrier to microbial breakthrough in the treated water may fail to measure up to our expectations. Conventional water treatment processes applied worldwide were not designed specifically to remove protozoan cysts or enteric viruses, and an approximately 3-log removal for *Cryptosporidium* oocysts can be expected for the entire treatment train, if it is operated properly (10). Any momentary or intermittent breaks in the treatment chain could allow substantial levels of pathogenic microbes to enter potable water. Unusual resistance of oocysts to conventional disinfectants (5) allows for penetration of viable oocysts into the treated water supply. Recent large-scale outbreaks of *Cryptosporidium* in many industrialized countries have shown that conventional drinking water treatment may not always be adequate to prevent waterborne disease transmission (12). In addition, the maintenance of water quality during distribution to the end user may not always be given careful attention. Thus, post-treatment contamination may occur in the distribution system due to microbial regrowth, infiltration, cross connection, back siphonage, line construction and repairs, and others (1,2,13).

The increasing world population leads to an increase in the requirement of fresh water for drinking, hygiene and household purposes, as well as for agricultural irrigation. Population growth also brings in its train a high load of municipal sewage, livestock excreta and industrial wastewater

on the source of drinking water, both the surface and ground water. Most fecal-oral pathogens are identified to cause gastrointestinal illnesses with a few exceptions such as hepatitis and other viruses. There may also be myriads of emerging pathogens which are excreted by humans or animals. In many industrialized countries, the widespread occurrence of the protozoan parasites in surface waters demonstrates that any drinking water treatment plant which draws its water from a surface source is at risk (12). At the same time, water utilities which draw their source from ground water under the direct influence of surface water is not necessarily free from this threat (9).

SHARING HEALTH RISK

The survival of pathogenic organisms in drinking water is the result of multiple problems within the water source, the collection system, the treatment chains, and /or the distribution and storage facilities. It is thus necessary in principle to implement a multi-barrier approach based on a total system concept. Considering the enormous variety of possible contaminants both at source and within the distribution system itself, developing a real-time monitoring system for each pathogen will be impractical. One interesting approach would be to adapt the use of Hazard Analysis Critical Control Point (HACCP) principles for drinking water risk management (14). It is designed primarily for food industries as preventive system of control to assure product safety where effort is applied to reduce or remove risks as close to their source as possible. Key features of HACCP are the identification of hazards and the specific measures to control hazards emphasizing elements that can be monitored, and verified, in real time. Water treatment processes that reduce the level of contamination in the source to produce safe drinking water require reliable information about the microbial quality of the source water. Fluctuation due to peak events (heavy rainfall, dredging a riverbed, etc) and the level and source of variation, should be taken into consideration. It also requires knowledge about the effectiveness of different treatment processes in inactivating or removing pathogens. These, together with knowledge about the sources and risk of post-treatment contamination, make it possible to determine the most relevant risk management options in the water distribution system.

As risk management is a total system approach, involvement of a multiple-disciplinary team is essential. Catchment control, for example, may involve events with transboundary hygienic and environmental impacts, and thus requires an interregional or in some cases international approach. This means that effective risk management requires acknowledgement and co-operation of various agencies. For risk management, linkage of disease-based and of environmental surveillance networks needs to be strengthened to integrate data on waterborne diseases on condition that the public health benefits of surveillance are balanced with the individual human rights to privacy.

WATERSHEDS AS NATURE'S BOUNDARIES FOR SURFACE WATER SUPPLIES

Although HACCP concept has been widely discussed for the production of safe drinking water at the present time, we should recognize one thing very basic that this management system can scarcely be applicable to the water treatment system if load of municipal sewage, livestock excreta and industrial wastewater are minimized on the source of drinking water. Measures should, then, be designed to reduce the microbial concentrations as far as possible in the source water by which we are able to reduce reliance on treatment for the protection of water quality in the conventional treatment chains.

Categorization of waterborne pathogens can be made by the combination of concepts such as the probability of an event and the severity of that event for the prioritization of the risk in the process of risk analysis. Recent concerns with *Cryptosporidium* and *Giardia* have centered on the method for water treatment, due to their unusual resistance to conventional disinfectants used worldwide. Many human activities have potential to disseminate *Cryptosporidium* and *Giardia* (oo)cysts into watersheds. These include livestock grazing, manure handling, human settlement, outdoor recreation and others. *Cryptosporidium* is known to be zoonotic, and infected calves deliver approximately 10^{10} oocysts daily for up to 2 weeks (4). It is likely that human patients also excrete a similar number. Fresh feces from grazing animals, yard and dairy washings and bedding leachates seem the most likely agricultural source of pathogenic agents including oocysts. It is not realistic, however, to ban all the economic and social activities in the catchment area. There are several key controls to keep pathogens from entering source waters: an appropriate level of grazing and the length of time without incurring damage to natural values, prevention and control of zoonotic diseases (animal health), correct handling and disposal of farm wastes (composting of manures)(11), and human settlement. Cattle kept in uplands might have little effect on water quality, as long as the range of the river is kept in good condition with riparian pastures (the ground cover provided by vegetation on land). Fencing around reservoirs and streams should be provided to restrict access by both farm animals and wildlife, though little is known about the prevalence of shedding among wildlife species. Improvement of off-stream animal water, at the same time, can disperse wildlife effectively from major watersheds and riparian pastures. In addition, as it is demonstrated that young animals, such as suckling and weaned animals (Table 1) are more likely to shed *C. parvum* oocysts (7,8), keeping young livestock away from the stream for a certain distance will also be an effective measure to mitigate impact of animal grazing on drinking water sources. It is clear that control of water contamination from agricultural wastes depends mostly on compliance with regulatory codes of agricultural practices for waste management. People have to be made aware that their voluntary

compliance with these regulations is essential, for them and their descendants to enjoy the benefit of safe drinking water.

HUMAN SETTLEMENTS, OUTDOOR RECREATION AND OTHERS

There is always a low level of cryptosporidiosis in the community among humans and animals (Table 2). While it is unlikely that drinking water is a major cause of this background level, it is also true that most fecal-oral microbial agents have the potential to be transmitted through contaminated water. Human settlements in watersheds shall be properly planned and controlled to prevent adverse effect on water sources. It is crucial to have appropriate sewage treatment plants or on-site sewage disposal systems that are able to deal with the risk arising from the release of infectious microbes into nearby waters.

As watersheds contain streams, lakes and forests, they are potential sites for various recreational activities like off-road and on-road motorizing, backpacking, swimming, boat sailing, windsurfing, rafting and others. Little is known on the effects of recreation on source water quality. It is, thus, recommended that researches should be conducted on the impacts of different types of outdoor activities on drinking water sources. Knowledge obtained from results of such studies should be promptly incorporated into the watershed management strategies. In reality, the level of protection provided to drinking water sources from human-related activities should appropriately balance the cost and benefits of having safe drinking water.

RISK COMMUNICATION

Those at greatest risk of waterborne diseases are infants and young children, people who are debilitated or living under unsanitary conditions, the sick, the immunocompromised and the elderly. Additional protective measures, including risk communication, to these risk groups should also be involved in the total risk management. In particular, it is important to note that immunocompromised individuals such as AIDS patients and those administering immunosuppressive medications are unable to clear cryptosporidial infection and severe diarrhea, while immunologically healthy individuals experience a transient diarrhea. In addition, cryptosporidial infection occurs readily among those with impaired immunity (3) resulting in a life-threatening gastroenteritis with high mortality (6). Together with development of safe drinking water resources, the crux of mitigation of risks associated with microbial infections is managing how such information is communicated, since this will play an important role in public perception and in the exchange of sound scientific information. Rapid local liaison with water companies and local public health authorities should be developed to assess the impact of cryptosporidial

contamination on water supplies. The prevalence of cryptosporidiosis among livestock in water sources as well as among the local population, sales of antidiarrheal medications, frequency of hospital emergency room visits for gastroenteritis, school absenteeism related to gastroenteritis in sentinel schools, and incidences affecting dissemination of *Cryptosporidium* oocysts through agricultural activities (manure storage, handling, disposal practices, etc.) are crucial for the detection of a current outbreak. Data sharing between authorities and the public (including the healthy population as well as those who have impaired immunity) should also be encouraged. Those who wish to take independent action to prevent/reduce the risk for waterborne cryptosporidiosis may choose to take precautions similar to those recommended during outbreaks, though the magnitude of the risk for ingesting *Cryptosporidium* oocysts from drinking water in a non-outbreak situation is uncertain. Education and counseling by the local health authorities at the local community basis, on one hand, is essential for the people's better understanding about the ways of transmission of cryptosporidiosis.

CONCLUSIONS

Almost two decades has passed since the first waterborne outbreak cryptosporidiosis due to *Cryptosporidium parvum* infection occurred. Since then, this obligate parasitic protozoan pathogen has become a significant public health concern that has potential to be readily transmitted through contaminated drinking water. Traditionally, the barriers for safe drinking water have included source water protection, physicochemical treatment, disinfection and protection of the distribution system. The treatment is not effective 100 % of the time in removing *Cryptosporidium* oocysts from the drinking waters, and unusual resistance of the oocysts to conventional disinfectants allows for penetration of viable oocysts into the treated water supply. It is, however, unwise to increase the capital outlays on the installation of additional treatment plants that would be needed to rescue poor sanitary source waters without giving much attention to the good source protection. Before it is too late, we should go back to the very basic concept that source water protection is crux to both the sanitary engineering and the cost-effective provision of safe drinking water. This, I believe, is the first alternative of the realistic ways of developing water resources to ensure adequate and safe drinking water for the next generation.

Strengthening alliances between local authorities and public health authorities as well as with water utilities for immediate appraisal of the potential health risk is conceptually another way to develop water resources for safe drinking water especially under conditions where there is less choice of source. At the same time, sharing health risks, monitoring efforts, treatment processes, and all other related information available with the public as well as with the media is also crucial to

protect consumers from waterborne diseases, where the performance of conventional systems becomes questioned.

REFERENCES

1. Centers for Disease Control 1990, Waterborne disease outbreaks . U.S. Department of Health and Human Services, Atlanta, GA. *Morb. Mortal. Wkly. Rep.* 39(RR-2):3.).
2. Craun GF 1986. Waterborne diseases in the United States. CRC Press, Boca Raton, FL
3. Cosyns M, Tsirkin S, Jones M, Flavell R, Kikutani H and Hayward AR, 1998. Requirement of CD40-CD40 ligand interaction for elimination of *Cryptosporidium parvum* from mice. *Infect Immun*, 66(2):603-607.
4. Current WL, 1985. Cryptosporidiosis. *J Am Vet Med Assoc*, 187(12):1334-1338.
5. Fayer R, Speer CA and Dubey JP, 1997. The general Biology of *Cryptosporidium*. pp. 1-42. Fayer R ed., *Cryptosporidium and Cryptosporidiosis*. CRC Press Boca Raton, FL
6. Flanigan T, Whalen C, Turner J, Soave R, Toerner J, Havlir D, and Kotler D, 1992 *Cryptosporidium* infection and CD4 counts. *Ann Intern Med* 15;116(10):840-842.]
7. Garber LP, Salman MD, Hurd HS, Keefe T, Schlater JL, 1994. Potential risk factors for *Cryptosporidium* infection in dairy calves. *J Am Vet Med Assoc*, 205(1):86-91.
8. Izumiyama S, Furukawa I, Kuroki T, Yamai S, Sugiyama H, Yagita K, Endo T, 2001. Prevalence of *Cryptosporidium parvum* infections in weaned piglets and fattening porkers in Kanagawa Prefecture, Japan. *Jpn J Infect Dis* 2001 54(1):23-26.
9. LeChevallier M 1997, What do studies of public water system groundwater sources tells us ? pp.56-73. In *Under the Microscope: examining microbes in groundwater*. American Water work Association, Denver, CO.
10. Ongerth JE and Hutton PE, 1995. Removing *Cryptosporidium* using multimedia filters. *Journal of the American Water Work Association* 87(12):83-89.
11. Pell AN, 1997. Manure and microbes: public and animal health problem? *Dairy Sci* 80(10):2673-2681.
12. Rose JB, Lisle JT, and LeChevallier M, 1997 Waterborne cryptosporidiosis: incidence, outbreaks, and treatment strategies. pp. 93-109. Fayer R ed., *Cryptosporidium and Cryptosporidiosis*. CRC Press Boca Raton, FL
13. Steinert M et al., 1998. Regrowth of *Legionella pneumophila* in a Heat-disinfected plumbing system. *Zent. bl. Bakteriologie*. 288:331-342.
14. Sobsey MD, Dufour AP, Gerba CP, LeChevallier MW and Payment P, 1993. Using a conceptual framework for assessing risks to health from microbes in drinking water. *Journal of the American Water Work Association* 85:44-48.

Table 1. Prevalence and crude odds ratio for excretion of *Cryptosporidium parvum* oocyst in porkers

Factor		Prevalence of <i>C. parvum</i> oocysts (%)		Crude odds ratio (95%CI)		<i>P</i> value
Weaned piglets	Farm A	52/148	(35.1%)	2.7	(0.6-12.8)	ns**
	B	10/24	(41.7%)	3.6	(0.6-20.0)	ns
	C	13/48	(27.1%)	1.9	(0.4-9.6)	ns
	D	2/12	(16.7%)	1.0*		

Age (month)						
Weaned piglets	1	69/213	(32.3%)	89.6	(12.3-652.9)	<0.001
	3	8/19	(42.1%)	136	(15.6-186.4)	<0.001
Fattening porkers	6 (Farm A)	1/187	(0.5%)	1.0*		

Weaned piglets	1-3	77/232	(33.2%)	125.2	(17.2-909.2)	<0.001
Fattening porkers	6	1/252	(0.4%)	1.0*		

(after Jpn. J. Infect. Dis 54:23-26, 2001.)

Table2. Detection of *Cryptosporidium* oocysts from fecal specimens of Diarrheal patients presented at Tokyo Metropolitan Komagome Hospital

Sources		Years											
		1990	1991	1992	1993	1994	1995	1996	1997	1998	1999	2000	Total
Imported		0/29	0/37	0/29	1/11	0/21	1/29	0/43	4/65	3/67	5/89	4/88	18/508
Domestic	Outpatients	0/23	0/29	0/7	0/4	0/8	0/1	0/17	0/37	0/51	0/32	0/49	0/258
	Inpatients	0/31	0/40	0/30	0/13	0/7	0/5	0/17	0/36	0/30	0/38	0/100	0/347
HIV/AIDS		0/3	0/7	1/3	0/1	0/1	0/5	1/9	0/17	1/17	0/27	1/50	4/140
Unknown			0/1	0/3									0/4
Total		0/86	0/114	1/72	1/29	0/37	1/40	1/86	4/155	4/165	5/186	5/287	22/1257

(after Clinical Parasitol., 12(1):89-91, 2001)

**15. Management of the health risks posed by
Cryptosporidium in sewage**

Presenter

Mr. Hiromasa Yamashita, Water Quality Control Department

Management of the health risks posed by *Cryptosporidium* in sewage

H. Yamashita, H. Nakajima and H. Saino

ABSTRACT

We conducted a nationwide monitoring study of *Cryptosporidium* levels in treated sewage for the quantitative risk evaluation. The risk of infection per capita on an annual basis is in the range 10^{-5} to 10^{-2} . In order to formulate standards for risk management, we drew up potential risk scenarios and considered the standards required for the target risk. The maximum theoretical concentration of *Cryptosporidium* in raw sewage is 10^6 /l. We developed two different countermeasure procedures in order to address both of the annual infection risk and the risk of a mass outbreak. When deviation from the probability distribution of *Cryptosporidium* concentrations in the observation data is used as the standard for developing countermeasures for a mass infection incident, the resulting annual infection risk may be below the target risk 10^{-2} , although the degree of risk reduction depends on the level and type of contact.

Introduction

In Japan, as elsewhere, the health risk posed by pathogenic microorganisms such as mad cow disease and O-157 has become an increasing problem. Following a large-scale outbreak of *Cryptosporidium* at Ogose in Saitama Prefecture in 1996, water and sewage authorities have been particularly concerned about water-borne pathogenic microorganisms and have instituted a range of countermeasures. Risk management of pathogenic microorganisms during sewage treatment, particularly *Cryptosporidium*, is increasingly important due to general advances in water risk management and the increasing use of reclaimed wastewater. In Japan, however, there is little continuous monitoring data available on *Cryptosporidium* levels in sewage and so few attempts have been made to perform quantitative risk evaluation. To this end, we conducted a nationwide monitoring study of *Cryptosporidium* levels in sewage for the purpose of quantitative risk evaluation. We also drew up a framework of countermeasures for potential risks, designed to provide a platform for developing risk management techniques and standards that can be used to ensure that risk levels do not exceed the threshold value.

Wastewater and Sludge Management Division, Water Quality Control Department
National Institute for Land and Infrastructure Management,
Ministry of Land, Infrastructure and Transport
1 Asahi, Tsukuba, Ibaraki, 305-0804, Japan

Cryptosporidium levels in sewage at present

Each month for a ten-month period from October 2001 to July 2002, we monitored Cryptosporidium concentrations at eight sewage treatment plants throughout the country. Concentrations were measured in raw sewage, secondary treated water, and reclaimed wastewater at each facility. Table 1 and Table 2 give an overview of the size and treatment process of the sewage treatment facilities involved in the study, while Table 3 summarizes the measurement results.

Table 1 Size of sewage treatment facilities

	Treatment area (ha)	Population serviced
Average	5,262	411,000
Maximum	10,543	770,000

Table 2 Sewage treatment process used at sewage treatment facilities

Sewage treatment process	Number of facilities
Biological secondary treatment	8
+ sand filtration	4
+ coagulation and sand filtration	2

Table 3 Cryptosporidium levels measured in sewage

	Raw sewage (per 200 ml)	Secondary treatment (per 20 l)	Sand filtration (per 20 l)	Coagulation and sand filtration (per 20 l)
Total Samples	79	49	20	20
Arithmetic mean	2.7	10.6	1.6	0.35
Variance	40.4	350.6	4.7	0.83
Standard deviation	6.4	18.7	2.2	0.91
Minimum	0 (of 39)	0 (of 11)	0 (of 8)	0 (of 16)
Maximum	35 (of 1)	117 (of 1)	9 (of 1)	3 (of 2)

Note: Measurements are per 15 – 19 l for several of the secondary treatment and sand filtration samples.

Table 4 shows the goodness-of-fit of the measurement data relative to the probability distribution, based on the likelihood ratios.

Table 4 Goodness-of-fit of probability distributions to Cryptosporidium distribution

	Poisson distribution		Negative binomial distribution		Poisson lognormal distribution	
	$-2 \ln(\Delta)$	$\mu =$	$-2 \ln(\Delta)$	$k =$	$-2 \ln(\Delta)$	$\eta =$ $s =$
Raw sewage	423.9	13.4	22.2	39.9	29.0	2.5
			1.6	1.6	1.8	
Secondary treated sewage	822.0	0.5	88.3	1.5	29.6	-0.6
			0.5	0.5	1.6	
Sand filtrated sewage	22.5	0.1	8.8	0.2	8.7	-2.0
			0.8	0.8	1.0	

Note:

1. Δ is the likelihood ratio, and $-2 \ln(\Delta)$ is -2 times the natural logarithm of the likelihood ratio. The smaller this figure, the better the goodness-of-fit.
2. μ and k are the gamma distribution average and shape parameter respectively for the negative binomial distribution, which is a combination of the Poisson and gamma distributions.
3. η and s are the lognormal distribution average (natural logarithm) and standard deviation (natural logarithm) respectively for the Poisson lognormal distribution, which is a combination of the Poisson and lognormal distributions.

For raw sewage, the negative binomial (NB) distribution and the Poisson lognormal (PLN) distribution had almost the same likelihood. For secondary treated water, goodness-of-fit was better for the PLN distribution, while for the sand filtrated sewage, the NB and PLN distributions were roughly the same.

The NB and PLN distributions are the combined distributions of the Poisson distribution (sampling process) and the gamma or lognormal distribution (average concentration), respectively.

Since it is not possible to determine at this stage which of the gamma and lognormal distributions produces a better overall fit to the distribution of *Cryptosporidium* concentrations, we performed the risk calculations on both distributions.

Evaluation of current risk levels

Table 5 shows the assumed ingestion volume and frequency of exposure for various categories of treated sewage discharge or reuse (Japan Sewage Works Association (2000)). These figures are used in risk evaluation.

Table 5 Ingestion volume and frequency of exposure for treated and reclaimed wastewater

Form of contact/reuse	Persons affected	Form of exposure	Frequency of exposure	Volume ingested per exposure
Bathing	Bath users	Accidentally swallowed while bathing	40 days/year	100 ml/day
Source water for waterworks	Tap water users	Drinking	365 days/year	2 l/day
Recreational water (parks)	Park users	Playing in water	100 days/year	10 ml/day
Landscape water (parks)	Park users	Fishing	2 days/week	1 ml/day
Flush toilet usage (office)	Office workers	Water splashes	5 days/week	0.1 ml/day
Sprinkling water (parks)	Park users	Contact with grass and plants	60 days/year	1 ml/day

The exponential model based on the data obtained by Dupont, et al. (1995) (shown in Expression 1 below) was used as the Cryptosporidium dose-response model.

$$P = 1 - \exp(-D/k) \quad (\text{Expression 1})$$

where,

P = probability of infection per exposure incident

D = exposure quantity (i.e. number of Cryptosporidium organisms) per exposure

k = parameter of exponential model (238.6)

Five hundred repetitions of the risk calculation were performed using the Monte Carlo method. The calculations were performed using Crystal Ball 2000™.

Figure 1 illustrates the annual infection risk as determined from the calculations, showing the average value for the risk distribution together with the minimum and maximum values for the 95% confidence interval.

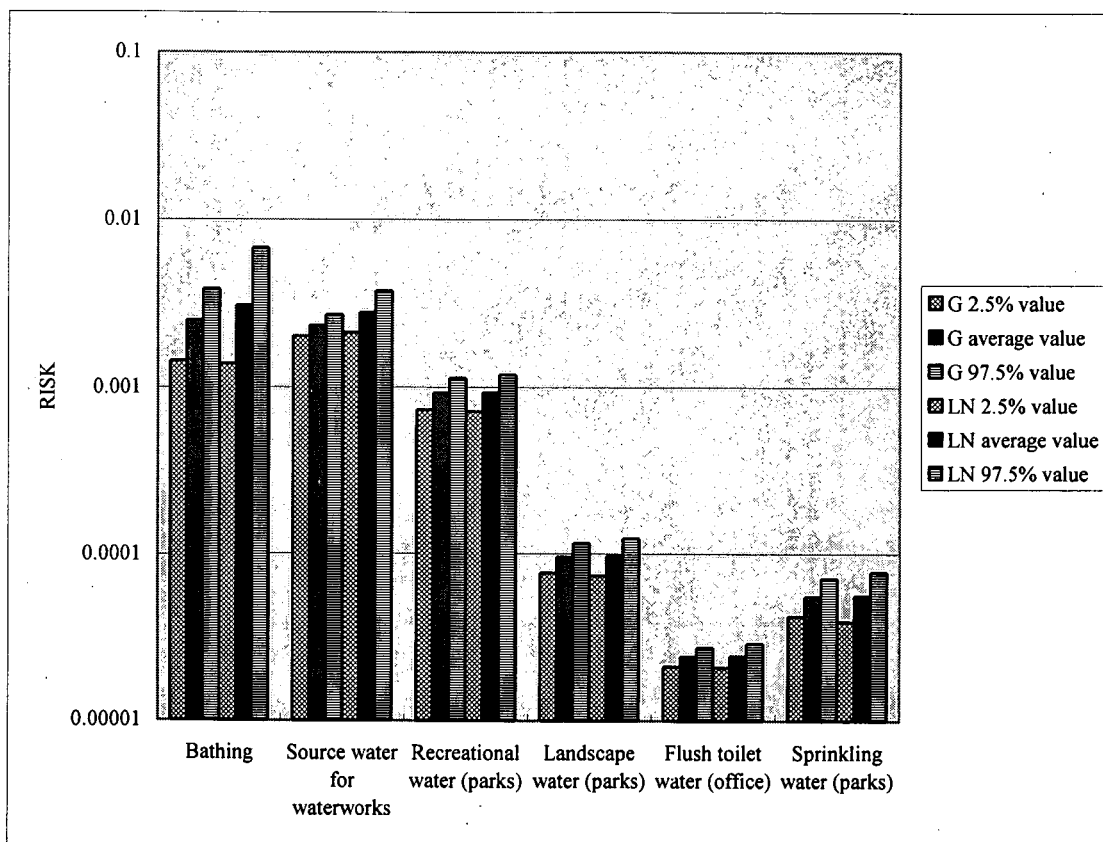

Figure 1 Annual infection risk range based on Monte Carlo simulation

Notes:

1. The G average, G 2.5%, and G 97.5% values are the average, the lower limit of the 95% confidence interval (the 2.5% value), and the upper limit (the 97.5% value), respectively, of the results from 500 repetitions using the gamma distribution to represent the distribution of Cryptosporidium concentrations.

2. The LN average, LN 2.5%, and LN 97.5% values are the average, the lower limit of the 95% confidence interval (the 2.5% value), and the upper limit (the 97.5% value),

respectively, of the results from 500 repetitions using the LN distribution to represent the distribution of *Cryptosporidium* concentrations.

The results show little major difference between using the LN distribution and the gamma distribution as the predicted distribution, although the LN distribution produces a slightly higher (and therefore slightly safer) forecast. For this reason, we have adopted the lognormal distribution as the predictor for the distribution of *Cryptosporidium* concentrations for the purpose of the calculations described below.

The annual infection risk values are distributed within the general range 10^{-5} to 10^{-2} . Even for the combination of factors producing the highest risk prediction—bathing in the waters that receiving secondary treated sewage discharge—the risk is less than 10^{-2} .

Risk scenarios

The single largest incident of mass infection in Japan occurred in Ogose, Saitama Prefecture, in 1996, when *Cryptosporidium* in the tap water supply caused diarrhea and other symptoms in 8,812 (roughly 70%) of the population of approximately 13,800 residents (based on a respondent base of 12,345). Department of Public Health of Saitama Prefecture (1997) reported that some 2,878 residents (33% of those experiencing symptoms) were forced to take time off from school or work due to sickness. 2,856 residents (32% of those with symptoms) sought diagnosis at a medical institution, and 24 were hospitalized. Figure 2 shows changes in the number of sufferers over time, based on actual records, together with the number of *Cryptosporidium* excretors, based on the assumption that each sufferer was excreting 10^9 *Cryptosporidium* over a two-week period with a sewage volume of 0.5 m^3 per person per day. Figure 3 shows changes in *Cryptosporidium* concentration levels in the raw sewage, where the entire area is considered to be a hypothetical town located within a single sewage treatment service area.

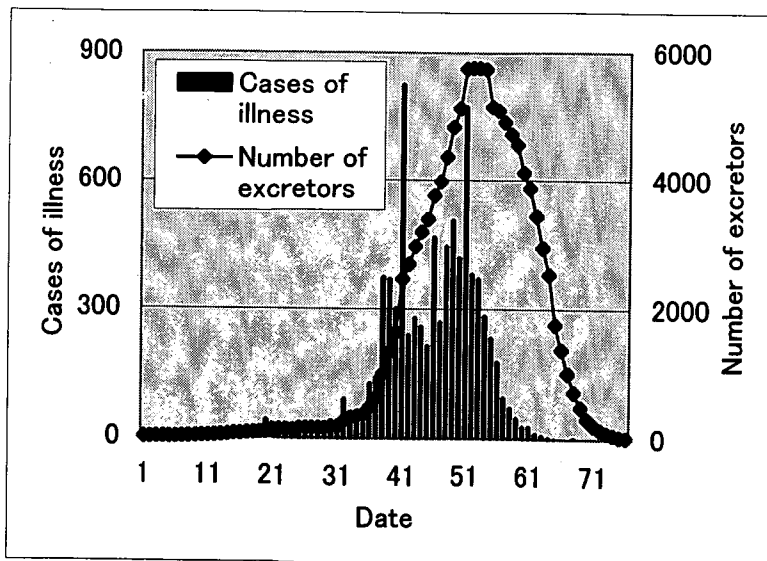

Figure 2 Changes in cases of illness and number of excretors

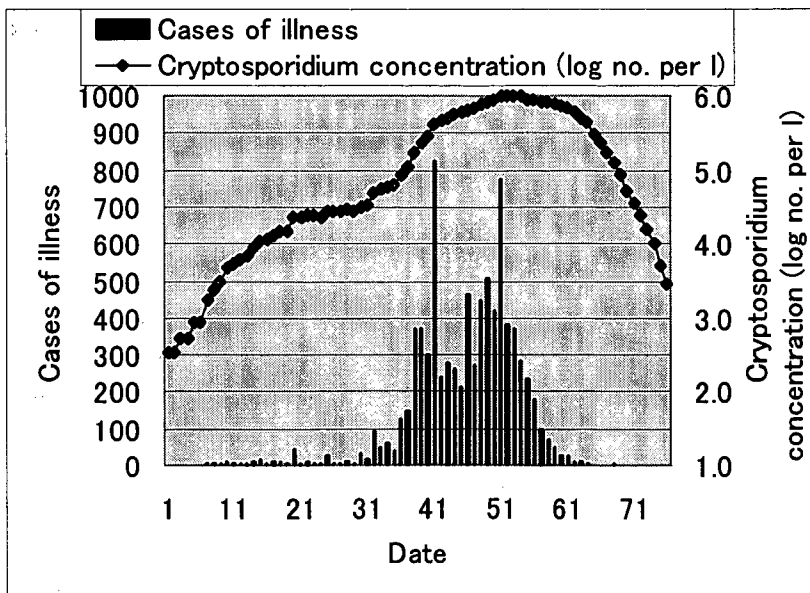

Figure 3 Changes in cases of illness and concentration of Cryptosporidium in raw sewage

According to the calculations, the maximum number of excretors at any one time is 5,760 persons. The excretion rate for 8,294 people (the total 8,812 sufferers less 518 persons for whom the timing of excretion is unknown) is approximately 0.694. Assuming that this figure is fixed for all sufferers, the true maximum number of simultaneous excretors is 6,120 persons ($8,812 \times 0.694$), or 49.6% of the survey respondent base of 12,345 persons.

Thus, approximately 70% of the total population was afflicted with the infection, and 70% of those (around 50% of the total population) were excreting at the same time. If we assume that half the population was excreting 10^9 Cryptosporidium and the sewage volume per capita per day was 0.5 m^3 , then:

$$0.5 \times 10^9 / (0.5 \times 10^3) = 10^6 / 1$$

This figure constitutes the maximum theoretical concentration of Cryptosporidium in raw sewage in Japan experienced to date. As such, this was the figure used as the theoretical maximum in developing strategies to combat Cryptosporidium.

Standards and countermeasures

Countermeasures for dealing with the risk of Cryptosporidium pathogens in treated sewage need to address two different phenomena.

Firstly, countermeasures need to address the stochastic phenomenon that is the annual infection risk. The normal concentration of Cryptosporidium in raw sewage has the potential to cause sporadic incidents of infection at any time. Since this risk essentially varies at random, the appropriate response is an on-going year-round risk minimization strategy based on annual average values.

The second, systematic phenomenon is the risk of a mass outbreak. In the event of a mass outbreak, *Cryptosporidium* levels will be considerably higher than normal for some time. Risk minimization in this case involves emergency procedures such as use of coagulants to reduce the concentration of *Cryptosporidium* discharged from sewage.

The flowchart in Figure 4 shows the basic procedure of an on-going infection risk minimization strategy.

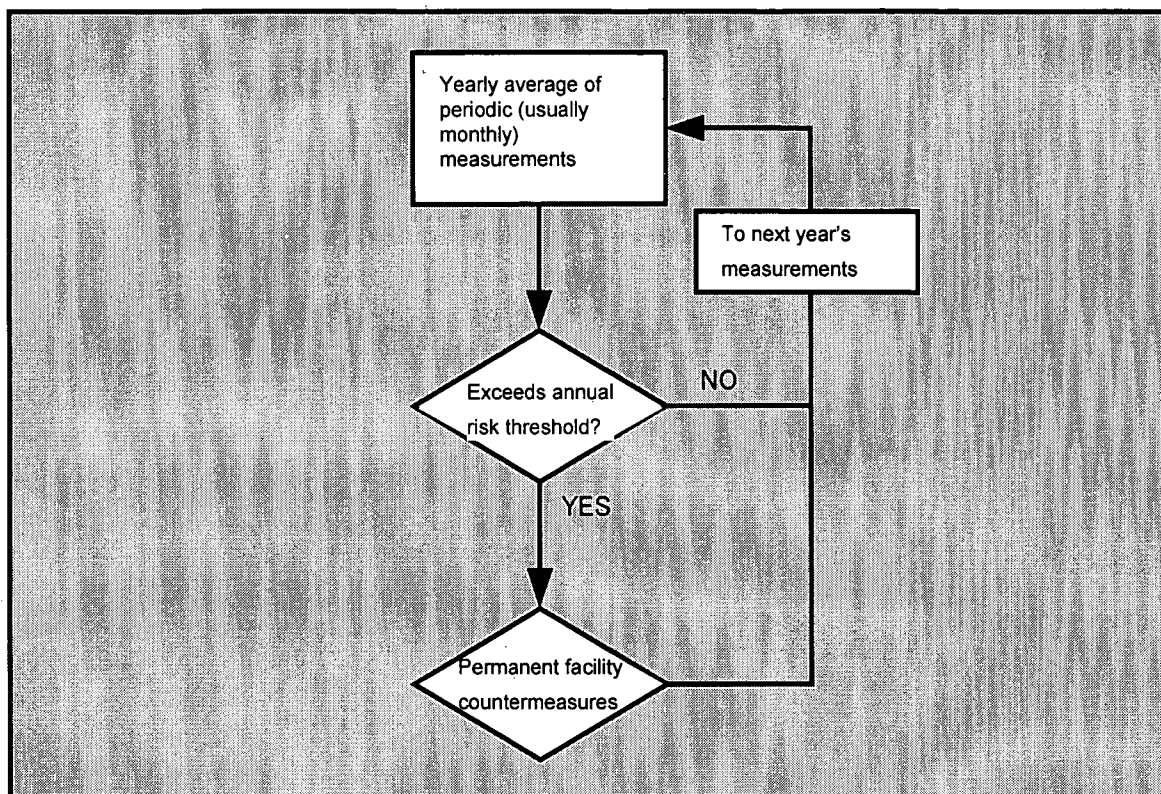

Figure 4 Ongoing year-round risk minimization strategy

It is assumed here that if the arithmetic mean of measurements taken over the year (i.e., the average of the 12 measurements) exceeds the risk threshold, then stronger disinfection procedures such as ultraviolet irradiation or ozone treatment will be necessary. We have proposed defining the annual risk threshold as the value needed to ensure that the annual risk of infection to any one individual is no greater than 10^{-2} . In the United States, the Environment Protection Agency suggests the maximum acceptable risk level as 10^{-4} . The *Cryptosporidium* risk level in Japan is currently in the range 10^{-5} to 10^{-2} . In the absence of a quantitative benefit-cost analysis on reducing the risk to 10^{-4} , let alone any public consensus on the cost of investment required, we have adopted 10^{-2} as the provisional threshold value, which can be agreed widely as the minimum countermeasure level.

The maximum daily tolerable exposure level (calculated on the assumption that exposure is uniform throughout the year) may be used as the threshold values.

The flowchart in Figure 5 shows the general procedure for countermeasures in the event of a mass outbreak.

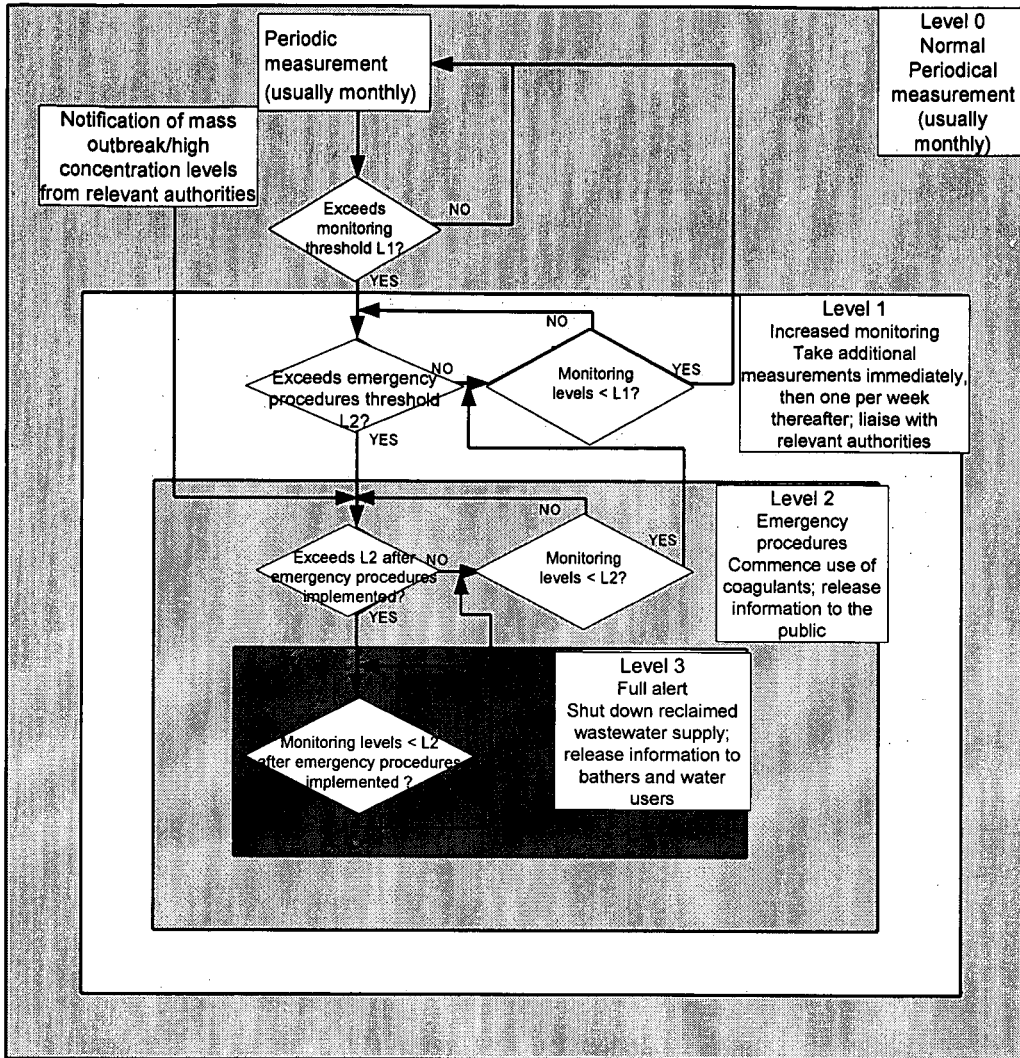

Figure 5 General procedure for countermeasures in the event of a mass outbreak

Where observed values deviate significantly from the lognormal distribution based on measurement data taken after secondary treatment and after sand filtration, this indicates an abnormal situation with the potential to cause a mass outbreak and emergency procedures should be instituted. L1, the threshold for increased monitoring, may be defined as the upper limit of the 95% confidence range for the distribution obtained from the geometric mean of certain number of samples (i.e., several consecutive separate measurements). L2, the threshold for emergency procedures, may also be defined in the same way. When the threshold value is exceeded, the relevant countermeasures are instituted. Ideally, the geometric mean of the measurements would be used for comparison with the threshold values; however, in cases where the latter of the consecutive measurements is higher and the concentration level appears to be on the increase, this situation may satisfy the prerequisites for the geometric mean. For this reason, in order to allow for a margin of safety, all of the consecutive measurement values are required to be below the geometric mean.

In some situations, the threshold for mass outbreak countermeasures may be lower than the threshold for annual infection risk countermeasures. If the former value is used and the mass outbreak countermeasures are properly instituted, then the annual infection risk will be well under the target value of 10^{-2} . The degree of risk reduction will depend on the level and type of contact.

Conclusions

In this paper we have described studies of countermeasures against the risk posed by the *Cryptosporidium* pathogen in sewage. The risk of infection by *Cryptosporidium* in sewage per capita on an annual basis is in the range 10^{-5} to 10^{-2} in Japan. The maximum theoretical concentration of *Cryptosporidium* in raw sewage is 10^6 /l. When deviation from the probability distribution of *Cryptosporidium* concentrations in the observation data is used as the standard for developing countermeasures for a mass outbreak, the resulting annual infection risk may be below 10^{-2} , although the degree of risk reduction depends on the level and type of contact.

The threshold values of the standards are currently under the review process among the members of our research project and thus not shown here. We will continue to pursue research in this area by generating more observation data and developing and refining detection methods and quantitative risk evaluation techniques. We also plan to develop superior pathogen risk management targets and risk management techniques based on quantitative risk-benefit analysis and risk communication.

Finally, the authors would like to thank the many local governments, universities, and others who have kindly assisted with this study. This study is part of a project undertaken by the National Institute for Land and Infrastructure Management entitled, "Sewage Technology Council—Microbiological Water Quality Project on Treated Sewage and Reclaimed Wastewater."

Reference

- Department of Public Health, Saitama Prefecture (1997). Report of Cryptosporidiosis Outbreak in Ogose Town (in Japanese).
- Dupont H.L., Tager I.B., Sterling C.R., Okkhuysen P.C., Rose, J.B., Jakubowski W. (1995). The infectivity of *Cryptosporidium parvum* in healthy volunteers. *The New England Journal of Medicine*, 16(4), pp. 855-859.
- Japan Sewage Works Association (2000). Final Report of the Committee for *Cryptosporidium* in sewage (in Japanese).

16. A Proactive Microbial Control In Philadelphia

Presenter

Jung J Choi, Philadelphia Water Department

A PROACTIVE MICROBIAL CONTROL IN PHILADELPHIA

Jung J. Choi
Philadelphia Water Department
October, 2002

INTRODUCTION

Some time ago, the Philadelphia Water Department (PWD) Public Affairs manager confided in her colleagues that the first time she heard of *Cryptosporidium* was while dining at a restaurant. She was alerted by a TV reporter seeking PWD's comment about a boil water emergency in Milwaukee resulting from protozoa in the drinking water. This happened in 1993 when the general public and even many water utility managers had little knowledge about *Cryptosporidium* during the 1980s. *Cryptosporidium* had only recently been identified by JN Rose and a few others in the 1980s, but is an emerging pathogen that has greatly affected the United States of America (USA) water industry.

There were also concerns related to *Giardia*, but they were generally relegated to unfiltered systems. Much of the attention and research were focused on identifying or treating chemicals in the drinking water such as pesticides, herbicides, heavy metals, and trihalomethanes, which are known as disinfection byproducts (DBPs). In the recent past, drinking water regulations were simple and well understood and the level of public interest and involvement in drinking water quality was generally low. That was then, but since 1990 the water industry has undergone rapid changes due to the occurrence of waterborne outbreaks of previously unknown "bugs" such as *Cryptosporidium*, as well as increasingly complex regulations. The 1990s can be characterized as the decade of the microbials as many utilities were confronted with outbreaks caused by *Cryptosporidium*. With advanced analytical techniques and research, scientists have also detected and found previously less known organic chemicals and DBPs such as haloacetic acids that might have adverse health effects on humans.

In this report, the USA water industry's perspectives on waterborne microbes and a local utility's efforts to meet the challenges to provide microbiologically safe drinking water will be presented.

Key Words: Microbial concerns, Safe Drinking Water Act Regulations,
Best Management Practices, Partnership

SAFE DRINKING WATER ACT REGULATIONS ON MICROBIALS

Drinking water quality in USA is regulated by the US Environmental Protection Agency (USEPA) under the statutory authority of the Safe Drinking Water Act (SDWA). While SDWA regulations greatly affect the water industry, as water utilities have to prepare and comply with requirements specified in SDWA regulations, the act has been a driving force in protecting the public from waterborne microbes. It has provided opportunities for the water industry to improve its research and treatment techniques related to microbials and DBPs.

In 1989, EPA issued two important National Primary Drinking Water Regulations (NPDW): The Total Coliform Rule (40 CFR 141.21) and the Surface Water Treatment Rule (SWTR) (40 CFR 141 Subpart H).

In the Coliform Rule, the EPA set a maximum contaminant level goal (MCLG) of zero and an MCL for total coliforms. If more than 5.0 % of the samples taken within a month contain coliforms within a month, a water system must report this violation to the state and the public.

The SWTR sets MCLGs for *Legionella*, *Giardia lamblia*, and viruses at zero since any exposure to these contaminants presents some level of health risk. Specifically, the rule requires that surface water has sufficient treatment, known as treatment technique (TT), to reduce the source water concentration of *Giardia lamblia* and viruses by at least 99.9 % (3 log) and 99.99 % (4 log), respectively. The rule does not account for systems with high pathogen concentrations and it does not specifically control for the protozoan *Cryptosporidium*. There are a number of well-documented waterborne outbreaks of Cryptosporidiosis that occurred during the 1990s, including an outbreak in Milwaukee in 1993 that killed over 50 persons and affected over 400,000 persons. Some of the water utilities where such outbreaks occurred were meeting federal and state standards for acceptable quality of drinking water.

In consideration of the above mentioned concerns and in the height of *Cryptosporidium* outbreaks that occurred in the earlier 1990s, the USEPA promulgated the Interim Enhanced Surface Water Treatment Rule (IESWTR) in 1998. This built on the SWTR by adding protection from *Cryptosporidium* through strengthened filter effluent turbidity performance standards (June 2001, IESWTR Implementation Guidance, EPA).

The rule lowers the combined filter effluent turbidity to 0.3 NTU in 95% of samples collected in a month, with no combined effluent having a turbidity of 1 NTU (see Supplementary Information). USEPA also promulgated the Stage 1 Disinfectants/Disinfection Byproducts Rule (DBPR) concurrently with the IESWTR to address risks associated with disinfectants and DBPs.

MICROBIAL CONTROL IN USA

Cryptosporidium is one of the most important pathogens in the USA and other countries (Public Health Handbook, 1997: *Cryptosporidium* and Water). It is ubiquitous in surface (JN Rose, 1991) and source waters (LeChevallier, 1991). Ordinary disinfection methods cannot kill *Cryptosporidium* oocysts, and even the best filtration units may allow a few organisms to pass through in treated water. Once infected, a healthy person will recover from illness within two weeks, however an immuno-compromised individual may not be able to recover and could possibly suffer chronic and debilitating symptoms. In addition to concern mounted over the difficulty in controlling *Cryptosporidium*, the water industry has been facing increasingly complex regulations, scientific uncertainties, aging infrastructure, and competition for limited resources.

While there were no simple answers and no magic solutions, the water industry believed that the best measure of efficiency for removing of microbes was by assessing plant performance for turbidity and particle removal and disinfection. During the earlier part of 1990s a well-coordinated effort was made between water utilities, USEPA, American Water Works Association and health authorities to brainstorm and to come up with an action plan that has the same voice and the same approach. Many utilities across the nation formulated programs to assess their systems through an evaluation of treatment as well as source water and distribution systems. Then, they prioritized deficiencies and limiting factors that had been identified and optimized their process by making the following corrections:

1. Identify Constraints
 - Regulatory
 - Water Quality
 - Operational
 - Management and Human Resources
 - Design & Engineering
 - Financial
2. Rank the Constraints on a Priority Basis
3. Develop Goals
 - Water Quality
 - Operational
 - Other
4. Estimate Costs and Reflect the Costs in Budgets
5. Assess the Possibility of Rate Increase
6. Correct or/and Optimize based on the Ranking
- 7 Identify Treatment Alternatives to address Future Regulations

With the exception of some small systems, many medium and large utilities have been able to upgrade their systems and improve treatment performance so that their treatment capability not only meet the SDWA regulations, but also operates at optimum efficiency for microbial removal and disinfection.

PWD is one of those utilities that has adopted best management practices and set stringent water quality goals beyond those of the existing regulations to better prepare for the future, especially for microbial concerns.

CASE STUDY: OPTIMIZATION

In many ways, PWD symbolizes larger utilities in the USA faced with numerous challenges that are in the process of meeting the challenges through optimization and long-term planning. Optimization usually means improving a process using existing resources. It applies not only in treatment areas, but also in the distribution system, communication and other administrative areas. Below is Philadelphia's experience to serve as an example of how many water utilities are improving water quality by source water protection, treatment optimization, and infrastructure integrity.

PWD's plants and distribution system are one of the oldest in the country. The plants were built almost 100 years ago and many of the mains and pumping facilities were constructed during the 19th century or early part of the 20th century. Some of the treatment facilities were renovated during the 1970s and 1980s, however, the existing systems could be regarded as outdated by today's standards.

In the early part of 1990s PWD began to look at microbial issues, especially the occurrence of *Cryptosporidium* and *Giardia*. All three treatment plants and their finished waters were meeting SWTR requirements and SDWA regulations. However, PWD was concerned with its source waters, which were suspected to contain protozoa, in light of the treatment plants' outdated systems especially for filter performance. In 1995, national and international experts teamed up with PWD personnel and examined the treatment facilities and identified various deficiencies at the plants. Their findings and recommendations helped establish short and long-term goals, as all parties concurred that PWD plants were vulnerable to microbial risks. Following this, PWD joined the Partnership for Safe Water, a joint program of USEPA/AWWA and the water industry, and began a composite correction program (CCP), from which it has greatly benefited. The self-assessment helped PWD identify deficiencies and factors that limited the plants' performance. The limiting factors identified through this self-assessment have since been prioritized and corrections and optimizations have been made. The findings were reflected in operational and 5-year capital budgets. In 1993, PWD began a research program, which involved monitoring PWD's drinking water sources and its finished water for *Giardia* and *Cryptosporidium*. PWD has also recruited personnel with strong academic credential to foster its research areas in microbes and DBPs.

Below are some examples of how the quality of finished water and plant management have been significantly improved. Over the past seven years each plant has upgraded all the processes enabling them to operate the system with turbidity levels at <0.06 NTU more than 99% of the time and the maximum allowable turbidity spike during the backwash at 0.3 NTU. Each filter has an online turbidity analyzer and is classified based on its physical integrity and performance. Each of the filter effluents has an online particle counter to measure particles of protozoan sizes that pass through the filter. The flocculation tanks have been renovated with improved baffling to achieve better mixing known as T₁₀ values. Chlorine is applied at multiple locations to avoid any failure in achieving a minimum C*T value (C, residual disinfectant concentration x T, contact time). The SWTR prescribes C*T levels for disinfectants, which will achieve different levels of inactivation under various conditions. For many water utilities disinfection is a priority and they achieve more credit for disinfection, as determined by their C*T values. For instance, PWD's daily average C*T values as an example range from 400 to 900%, which is much more than it is required.

If the plant fails to maintain any of the prescribed goals, the manager must notify his superior and PWD's water quality division, though performance typically exceeds USEPA requirements.

Pilot plants were installed in 1998 and they have provided critical information in calibrating and optimizing existing processes such as finding the optimum pH for coagulation and DBP formation control. Also, they have provided the basis for evaluating the feasibility of applying alternatives such as ozone, UV, dissolved air floatation (DAF) and plate settling. Through a plant-scale study, PWD is using potassium permanganate as a pre-oxidant for replacing chlorine dioxide and free chlorine. It was found that pH 6.5 for ferric chloride and pH 5.5 for alum were ideal levels for optimizing the coagulation wherein particles and NOM would be removed most effectively. However, algae blooms in the watersheds (i.e., diatoms) can threaten the optimum performance of coagulation and filtration. In such cases, polyelectrolytes (known as polymers) can be used as coagulant aids. A variety of cationic, an ionic and ampholytic (has both positive and negative) products that have been approved for use in drinking water treatment by water utilities are now in use. More than half of the water plants in the U.S. use one or more polymers to improve treatment efficiency (1998 Chemistry of Water Treatment, Faust et al).

As noted, water utilities in the USA choose treatment chemicals that are economically feasible and work for their own processes. National Sanitary Foundation (NSF) provides information about commercial chemicals and substances that can be used in treatment and distribution systems. PWD reviews the products listed in NSF and tests them to assure that the quality of the products are maintained.

In addition to treatment improvement, PWD considers that protecting its watersheds and the distribution system to be equally important for providing safe water to customers. The source waters for the plants have long been of concern because they contain various contaminants such as protozoa and coliforms that may originate from creeks outside of the utility's boundary and from other sources such as storm water and combined sewer overflow in the city. In 1998, PWD created a new unit to focus on watershed management to address these concerns.

Under the PWD's distribution water quality policy, new pipes must have caps on the pipe ends and newly installed pipes must be disinfected and tested. Existing pipes that require repairs or that are taken out of service must also be disinfected and tested. A cross connection control policy stipulates that all buildings and facilities, except small homes must install cross connection control devices (backflow preventers) on their service lines and PWD will shut off a building's water service if it has no backflow preventer. A cross connection is an improper connection between a drinking water and a non-drinkable system. The USEPA and the water industry recognize that cross connections have been the leading causes of outbreaks and other major water quality problems in the USA.

PWD has a Water Quality Committee to better communicate with the public on water issues and to help the executive staff make decisions when a serious microbial problem occurs. The committee has developed a microbial communication plan with Health Department physicians to address waterborne microbial events and assist the Mayor or Water Commissioner in making decisions concerning events. For instance, if E.coli or other microbes are detected or there is an indication of treatment defect the Health

Department will track the number of cases of Giardiasis, Cryptosporidiosis and acute diarrheas so that the committee can assess the situation.

PARTNERSHIP

PWD has actively participated in USEPA's regulatory process and supported AWWA, which represents the water industry. PWD helps USEPA by providing research reports and data and comments on proposed regulations.

At the same time USEPA and AWWA have greatly helped PWD and other water utilities on plant optimization and other improvements by offering "Partnership for Safe Water Program" and training and guidance (i.e., Technologies for Upgrading Existing or Designing New Drinking Water Treatment Facilities, EPA/625/4-89/023). Since the early 1990s AWWA has offered satellite conferences on treatment, DBPs, distribution and other water quality issues which recognized as a highly effective and instrumental for the water industry.

PWD is member of the Waterworks Management Workshop Group. It consists of 17 major water utilities, which meet twice a year to exchange specific information on their operations and experiences including treatment techniques and process control, distribution infrastructure management, water quality, and laboratory issues. Before the meeting, they solicit and answer related questions electronically.

ALTERNATIVE AND ADVANCED MICROBIAL CONTROL

While PWD has been able to meet the new regulations (i.e., IESWTR, Stage 1 DBPR), ozonation and ultraviolet (UV) radiation are also being studied as alternate treatment techniques to balance microbial and DBP issues and address future regulations and uncertain water quality concerns. UV radiation has been receiving increased attention since UV systems are proved to reliably achieve high levels of disinfection at moderate UV doses with no DBPs and relatively low costs (2000 PWD's Water Treatment Plant Optimization and Advanced Treatment Pilot Studies). Costs for constructing the above mentioned systems have also been greatly reduced in recent years.

DISCUSSION

The water industry's environment has been changing rapidly with increased awareness and expectations from customers on water quality. The public water utilities, which traditionally had little competition for their products, are in the era of the Consumer Confident Report. Under the Right to Know Rule, water utilities are required to annually publish and distribute their water quality results to customers. This is analogous to a school report card so that well-informed customers can see whether their water supplier did well or poorly compared to the quality of drinking water treated elsewhere.

In general, water quality regulations may be a baseline for setting performance and water quality goals. In fact, EPA recommends that all parameters be at least one half of the maximum contaminant levels (MCLs). However, many utilities across the nation including PWD have gone beyond the regulations and set higher performance and water quality standards. There are still a variety of water quality concerns that are not addressed by the

drinking water regulations such as public perception, emerging issues that may require future regulations, and uncertainty about health effects.

Providing drinking water is a public trust and creates a unique responsibility for the water industry in the USA. Water utilities must balance their efforts to make the drinking water microbiologically safe while minimizing the production of DBPs.

PWD must continue to meet these challenges, but we can not do it alone nor without specific goals.

A PROACTIVE APPROACH TO MICROBIAL CONTROL IN PHILADELPHIA

Jung J. Choi
Philadelphia Water Department
USA

OVERVIEW

- Introduction
- Microbial Concerns
- Microbial Controls

INTRODUCTION

- City of Philadelphia
- Philadelphia Water Department

PHILADELPHIA

- First Capital in US
- 2nd Largest City on the East Coast with 1.5 Million Population
- Population has decreased over the last 30 Years

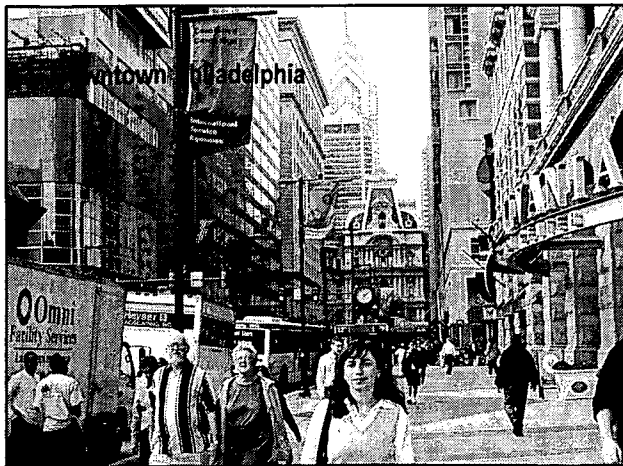

PHILADELPHIA WATER DEPARTMENT

- Founded in 1799
- Pumping River Water with Steam-powered Engine began in 1801
- Filtration began in 1901 and Chlorination began in 1913
- Three Treatment Plants with 3,300 Miles of Piping

Pumping Stations on the Schuylkill River
Constructed in
1801 (Left) and 1870 (Right)

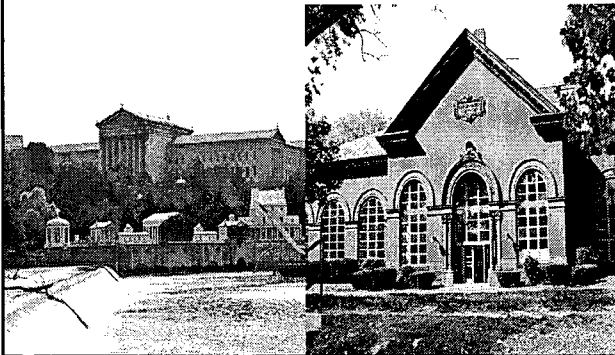

US WATER UTILITY CONCERNS ON MICROBES



- **Watershed Challenge:**
Where & What are the Source? How and Who will Control?
- **Treatment Challenge:**
What Level to meet the Current & Future Regulations? Process Control and Reliability

Courtesy: USEPA

US WATER UTILITY CONCERNS ON MICROBES

Adeno Virus: Courtesy USEPA

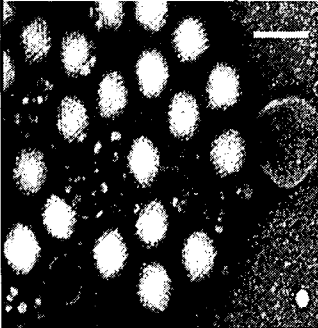

- **Microbial vs. Disinfection Control**
- **Analytical Challenge:**
Sampling, Testing, Recovery
- **Early Warning Issues, Viability Issues**
- **Public Health Challenge:** Can We Correlate Disease Occurrence to Density and Endemic Rate

US WATER UTILITY APPROACH ON MICROBES

- **Priority:** Turbidity/Particle Removal & Disinfection
- **Action:**
 - ☞ Self assessment
 - ☞ Optimization
 - ☞ Research: Occurrence, Removal, Alternate treatment
- **Education and Communication**

CASE STUDY - PHILADELPHIA EXPERIENCE

PROBLEMS IDENTIFIED IN 1990 - 1993

- Source Water Concerns
- Treatment Deficiencies
- Distribution Issues

PROBLEMS IDENTIFIED IN 1990 - 1993

- **Source Water Concerns:**
 - Protozoa found in Source Waters
 - Some Sewer Pipes interconnected with Storm Water Pipes
 - Contaminants Discharged from Neighboring Communities Upstream of City

PROBLEMS IDENTIFIED IN 1993-1994

- **TREATMENT DEFICIENCIES**
 - Process Control and Reliability Concern
 - *Cryptosporidium* resistant to PWD's Conventional Chlorine Treatment
 - Complacency: No Outbreaks, No Problem Meeting SDWA, No Competition

PROBLEMS IDENTIFIED IN 1990 - 1992

- **DISTRIBUTION ISSUES**
 - Aging Infrastructure
 - Reservoir Structures/Hydraulic Operations
 - Cross Connections and Backflow
 - Main Replacement Practices

BEST MANAGEMENT PRACTICES:

- " Multiple Barrier " from Watershed to Tap
- Emphasis on Research
- Emphasis on Communication and Education
- BMP Initiated by Technical Staff



PHILADELPHIA'S ACTION: 1993 - PRESENT

- Allocate, Recruit Technical Resources
- Research: Monitoring, Pilot Plants
- Conduct Expert Workshop
- Join "Partnership for Safe Water"
- Perform Self-Assessment: Composite Correction Program
- Optimize: Treatment, Watershed, Distribution, Management

SOURCE WATER PROTECTION

- Form Office of Watersheds to Specialize in Watershed Protection
- Watershed Monitoring and Surveillance Partnership with Community Groups and State of Pennsylvania
- Identify and Correct Illegal Connection to Storm Water System

Watershed Surveillance

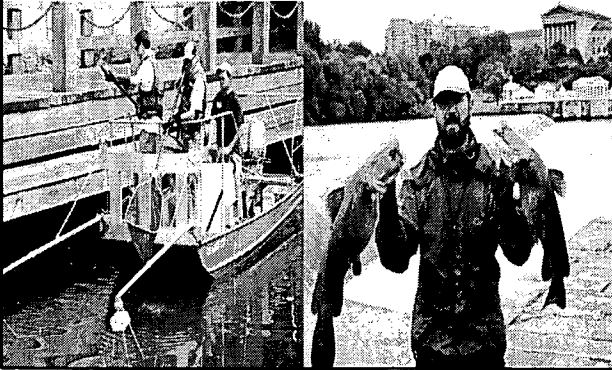

TREATMENT OPTIMIZATION

- Conduct Expert Workshop
- Join "Partnership for Safe Water"
- Perform Self-Assessment by Composite Correction Program
- Optimize Treatment Processes

TREATMENT OPTIMIZATION

- CCP: Identify Limiting Factors
- Prioritize the Limiting Factors
- Set Performance and Water Quality Goals
- Obtain Finance and Management Support
- Optimize Based on Ranking: i.e., Filter Classification, C*T Increase
- Enhance Monitoring for Process Control

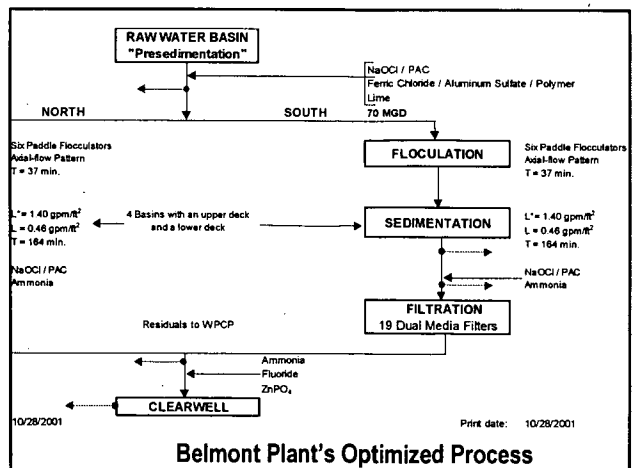
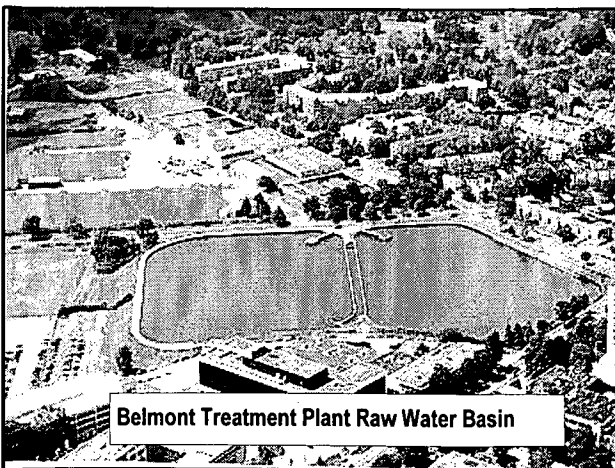
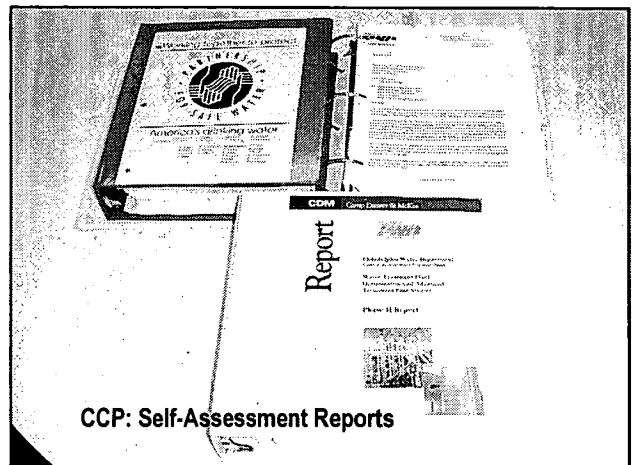

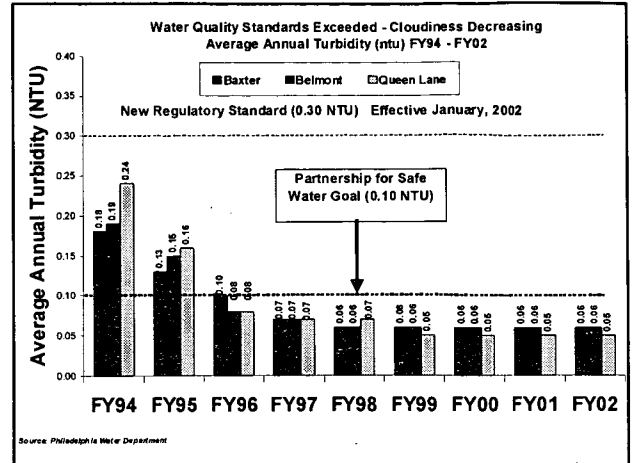
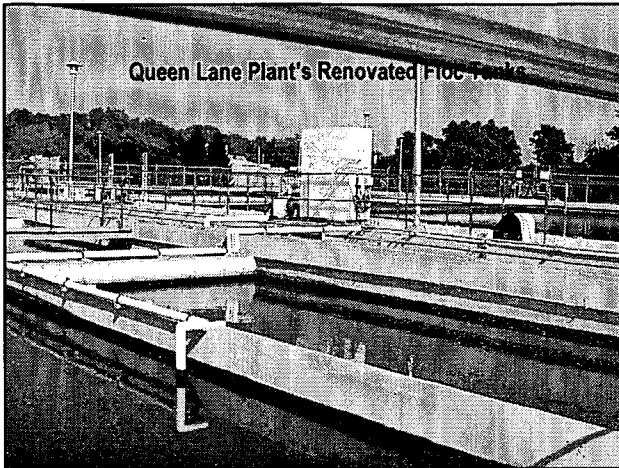

DISTRIBUTION WATER QUALITY CONTROL

- Enhance Water Quality Monitoring
- Rehabilitate Reservoirs
- Train and Enforce Sanitary Practices for Main Repair and Replacement
- Issue Cross Connection Control Regulation and Enforce the Regulation

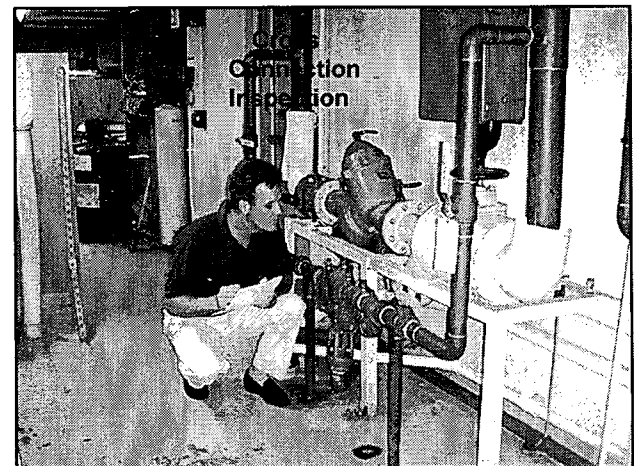

Oak Lane Reservoir Rehabilitation: 1996

EMPHASIS ON RESEARCH

- Treatment Optimization and Process Adjustment through Pilot Plant Studies
- Research on Turbidity & Particle Count Removal
- Research on Protozoa Detection, Occurrence and Removal

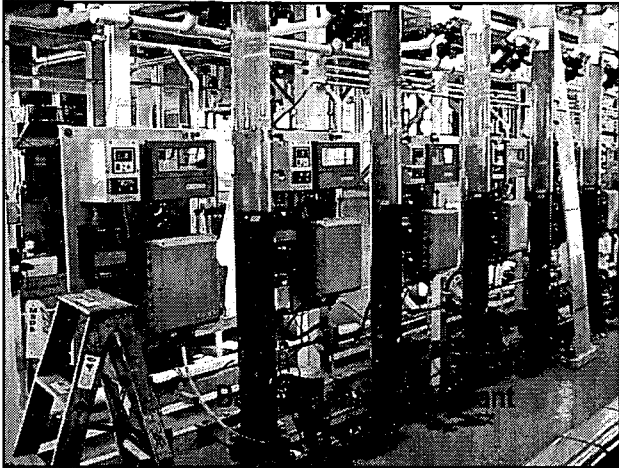

EMPHASIS ON COMMUNICATION AND EDUCATION

- Microbial Response with City Health Department
 - Offer Media Workshop with Health Department Disease Control Experts
 - Implement a Microbial Communication Plan with Health Department

MICROBIAL COMMUNICATION RESPONSE

- If Major Water Quality Problem Occurs
 - ✓ Review Operation Performance and Water Quality Data
 - ✓ Increase Monitoring including Protozoa Testing
 - ✓ Review Gastrointestinal, Diarrhea Reports
 - ✓ Take Corrective Action and Notify the State of Pennsylvania and the Public

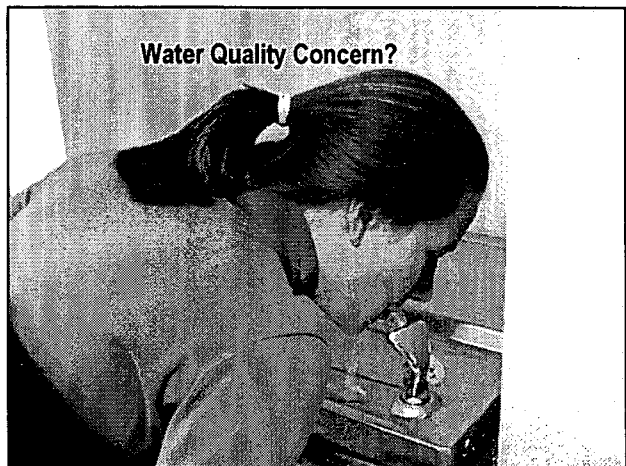

17. Endocrine Disrupting Chemicals

Presenter

Dr. Shoichi KUNIKANE, National Institute of Public Health

ENDOCRINE DISRUPTING CHEMICALS

Shoichi Kunikane

ABSTRACT

Endocrine disrupting chemicals(EDCs) are of great concern in Japan. We have been conducting researches on EDCs in drinking water. As the result, DEHP, DBP and BPA frequently occurred in raw water for drinking water supply. The maximum concentrations of DEHP, DBP and BPA were 0.53, 0.65 and 0.23 $\mu\text{g/l}$ in raw water and 0.26, 0.18 and <0.01 $\mu\text{g/l}$ in treated water, respectively. DEHP, BPA and NP could be removed by both conventional and advanced water treatment systems very well. Water pipes used for drinking water supply released DEHP, DBP, BPA and NP depending on the type of pipe material especially when they were newly installed, but the release did not last for a long time.

INTRODUCTION

Endocrine disrupting chemicals(EDCs) are of great concern not only among researchers but also among all people in Japan especially since the Environmental Agency disclosed their list, "SPEED 98" in 1998. Since then, we have been conducting studies on EDCs in water in order to collect information that can be used for estimating human uptake of EDCs through drinking water and assessing technologies for their effective control. The studies include their occurrence in raw and treated waters, behavior and removal in water treatment processes, and release from water pipes used for drinking water supply.

In this paper, the result of some studies on the occurrence of EDCs in raw and treated waters, removal and behavior of EDCs in drinking water treatment processes, and the release of EDCs from water pipes is reported and discussed.

OCCURRENCE OF EDCS IN RAW AND TREATED WATERS

The Japan Water Research Center(JWRC) conducted a surveillance on the occurrence of 68 chemicals including EDCs in raw and treated waters at 45 water treatment plants, 40 surface and 5 ground water treatment plants, all over Japan in 1999. Selected chemicals were ester phthalates, alkyl phenols, styrenes, organic tins, hormones,

Shoichi Kunikane: Department of Water Supply Engineering, National Institute of Public Health, Shirokanedai 4-6-1, Minato-ku, Tokyo 108-8638, Japan

pesticides and their by-products, and other related chemicals. Water sampling was done two times; first in July-October 1999 and second in October-December 1999. Both raw and treated waters were taken at the first sampling, but only raw water was taken at the second sampling. Samples were analyzed according to the "Provisional Manual for a EDCs Study" prepared by the Environment Agency.

As the result, out of 68 organic substances, 3 ester phthalates/adipates, 10 phenolic compounds, 5 pesticides and 1 organic chemical were found in raw waters, and 3 ester phthalates/adipates, 2 phenolic compounds, 3 pesticides were found in treated waters. Diethylhexyl phthalate was found most frequently both in raw water(88%) and in treated water(82%). Bisphenol A was also found frequently in raw water but seldom in treated water, which was probably due to degradation by chlorination in drinking water treatment. The maximum concentrations of DEHP, DBP and BPA were 0.53, 0.65 and 0.23 µg/l in raw water and 0.26, 0.18 and <0.01 µg/l in treated water, respectively. Such a result as described above was similar to that of a previous surveillance on the occurrence of 33 chemicals, including EDCs listed in the "SPEED '98," conducted in 1998.

REMOVAL AND BEHAVIOR OF EDCS IN DRINKING WATER TREATMENT PROCESSES

In order to know the removal and behavior of EDCs in drinking water treatment processes, such as coagulation/sedimentation, rapid sand filtration, ozonation and activated carbon filtration(BAC), we conducted an experiment using two advanced treatment pilot plants in Tokyo Metropolitan Water Supply and Osaka City Water Supply. The treatment flows are as follows:

Tokyo plant

1st line: Chlorination – coagulation/sedimentation - filtration

2nd line: Coagulation/sedimentation - sand filtration - ozonation -
activated carbon filtration - sand filtration

Osaka plant

Coagulation/sedimentation - ozonation - sand filtration - ozonation
- activated carbon filtration(BAC)

Four chemicals, such as diethylhexyl phthalate(DEHP), dibutyl phthalate(DBP), bisphenol A(BPA) and nonyl phenol(NP), were selected as target chemicals because they often occur in raw and treated waters in Japan. As their concentrations in raw waters of those pilot plants were usually very low, we sometimes spiked them into raw

Table 1 Occurrence of EDCs and other related chemicals in raw and treated waters

No.	Substance	QDL	Raw water				Treated water	
			Range detected	Detected/Measured			Range detected	Detected/Measured
				mg/l	Summer	Winter		
1	Diethylhexyl phthalate, DEHP	0.00005	ND~0.00053	42/45	37/45	79/90	ND~0.00026	37/42
2	Diethyl phthalate	0.00005	ND	0/45	0/45	0/90	ND	0/42
3	Di-n-butyl phthalate, DBP	0.00005	ND~0.00065	13/45	8/45	23/90	ND~0.00018	5/42
4	Buthylbenzyl Phthalate	0.00005	ND	0/45	0/45	0/90	ND	0/42
5	Di-2-ethylhexyl adipate, DEHA	0.00001	ND~0.00002	1/45	0/45	1/90	ND~0.00002	2/42
6	Dicyclohexyl phthalate	0.00005	ND	0/45	0/45	0/90	ND	0/42
7	Di-n-propyl phthalate	0.00005	ND	0/45	0/45	0/90	ND	0/42
8	Dipentyl phthalate	0.00005	ND	0/45	0/45	0/90	ND	0/42
9	Di-n-hexyl phthalate	0.00005	ND	0/45	0/45	0/90	ND	0/42
10	Bisphenol A	0.00001	ND~0.00023	14/45	15/45	29/90	ND	0/42
11	2,4-Dichlorophenol	0.00001	ND~0.00003	0/45	1/45	1/90	ND	0/42
12	Phenol	0.00001	ND~0.00005	1/45	18/45	19/90	ND~0.00001	1/42
13	4-Ethylphenol	0.00001	ND~0.00021	0/45	1/45	1/90	ND	0/42
14	2-tert-Buthylphenol	0.00001	ND~0.00002	1/45	0/45	1/90	ND	0/42
15	2-sec-Buthylphenol	0.00001	ND~0.00002	2/45	0/45	2/90	ND~0.00002	1/42
16	3-tert-Buthylphenol	0.00001	ND	0/45	0/45	0/90	ND	0/42
17	4-tert-Buthylphenol	0.00001	ND~0.00002	0/45	1/45	1/90	ND	0/42
18	4-sec-Buthylphenol	0.00001	ND	0/45	0/45	0/90	ND	0/42
19	4-Octyl phenol	0.00001	ND	0/45	0/45	0/90	ND	0/42
20	4-tert-Octyl phenol	0.00001	ND~0.00001	1/45	1/45	2/90	ND	0/42
21	Nonyl phenol	0.00001	ND	0/45	0/45	0/90	ND	0/42
22	4-n-Nonyl phenol	0.00001	ND	0/45	0/45	0/90	ND	0/42
23	2-Hydroxybiphenyl	0.00001	ND~0.00001	1/45	0/45	1/90	ND	0/42
24	3-Hydroxybiphenyl	0.00001	ND	0/45	0/45	0/90	ND	0/42
25	4-Hydroxybiphenyl	0.00001	ND~0.00001	0/45	1/45	1/90	ND	0/42
26	Octachlorostyrene	0.00003	ND	0/45	0/45	0/90	ND	0/42
27	1,3-Diphenylpropane	0.00001	ND	0/45	0/45	0/90	ND	0/42
28	cis-1,2-Diphenylcyclobutane	0.00001	ND	0/45	0/45	0/90	ND	0/42
29	trans-1,2-Diphenylcyclobutane	0.00001	ND	0/45	0/45	0/90	ND	0/42
30	2,4-Diphenyl-1-butene	0.00001	ND	0/45	0/45	0/90	ND	0/42
31	2,4,6-Triphenyl-1-hexene	0.00001	ND	0/45	0/45	0/90	ND	0/42
32	1,2,4,6-Tetraphenyl-1-hexene (1-pnenyretmyl) tetralin	0.00001	ND	0/45	0/45	0/90	ND	0/42
33	Styrene monomer	0.00001	ND	0/45	0/45	0/90	ND	0/42
34	Tributyltin	0.000005	ND	0/45	0/45	0/90	ND	0/42
35	Triphenyltin	0.000001	ND	0/45	0/45	0/90	ND	0/42
36	Ethinyl estradiol	0.000002	ND	0/45	0/45	0/90	ND	0/42
37	17 β -Estradiol	0.000002	ND	0/45	0/45	0/90	ND	0/42
38	Benzoepin/Endosulfan	0.00005	ND	0/45	0/45	0/90	ND	0/42
39	Malathion	0.00001	ND~0.00003	1/45	0/45	1/90	ND	0/42
40	Methomyl	0.00001	ND~0.00013	3/45	0/45	3/90	ND~0.00001	1/42
41	Benomyl (as MBC)	0.00001	ND~0.0002	0/45	2/45	2/90	ND	0/42
42	Carbaryl	0.00001	ND	0/45	0/45	0/90	ND	0/42
43	Alachlor	0.00001	ND	0/45	0/45	0/90	ND	0/42
44	Trifluralin	0.00005	ND	0/45	0/45	0/90	ND	0/42

Note) "ND" means not detected above a quantitative detection limit.

Table 1 Occurrence of EDCs and other related chemicals in raw and treated waters
(continued)

No.	Substance	QDL	Raw water				Treated water	
			Range detected	Detected/Measured			Range detected	Detected/Measured
				mg/l	First	Second		
45	Hexachlorobenzene	0.00005	ND	0/45	0/45	0/90	ND	0/42
46	o,p'-DDT, p,p'-DDT	0.00005	ND	0/45	0/45	0/90	ND	0/42
47	Ardrin	0.00005	ND	0/45	0/45	0/90	ND	0/42
48	Endrin	0.00005	ND	0/45	0/45	0/90	ND	0/42
49	Dieldrin	0.00005	ND	0/45	0/45	0/90	ND	0/42
50	Heptachlor	0.00005	ND	0/45	0/45	0/90	ND	0/42
51	trans, cis-Chlordane	0.00005	ND	0/45	0/45	0/90	ND	0/42
52	Methoxychlor	0.00005	ND	0/45	0/45	0/90	ND	0/42
53	Hexachlorocyclohexane, HCH	0.00001	ND~0.00002	1/45	0/45	1/90	ND~0.00001	1/42
54	Amitrole	0.00005	ND	0/45	0/45	0/90	ND	0/42
55	2,4,5-Trichlorophenoxyacetic acid	0.00005	ND	0/45	0/45	0/90	ND	0/42
56	1,2-Dibromo-3-chloropropane	0.00001	ND	0/45	0/45	0/90	ND	0/42
57	Nitrofen	0.00005	ND	0/45	0/45	0/90	ND	0/42
58	Pentachlorophenol, PCP	0.00001	ND~0.00004	2/45	2/45	4/90	ND~0.00001	1/42
59	tarns-Nanochlor	0.00005	ND	0/45	0/45	0/90	ND	0/42
60	p,p'-DDE, o,p'-DDE	0.000001	ND	0/45	0/45	0/90	ND	0/42
61	p,p'-DDD, o,p'-DDD	0.00001	ND	0/45	0/45	0/90	ND	0/42
62	Heptachlor epoxide	0.00005	ND	0/45	0/45	0/90	ND	0/42
63	Oxychlordane	0.00005	ND	0/45	0/45	0/90	ND	0/42
64	Benzo(a)pylene	0.00001	ND	0/45	0/45	0/90	ND	0/42
65	Polybrominated biphenyls	0.00001	ND	0/45	0/45	0/90	ND	0/42
66	4-Nitrololuene	0.00001	ND	0/45	0/45	0/90	ND	0/42
67	n-Butylbenzene	0.00001	ND	0/45	0/45	0/90	ND	0/42
68	Benzophenone	0.00001	ND~0.00002	1/45	2/45	3/90	ND	0/42

water(at Tokyo plant) or the water after sedimentation and before ozonation(at Osaka plant) at a concentration of 1 or 5 µg/l for each chemical. The experiment was done several times at each plant in 1999-2001.

The result has shown that all of these chemicals can be removed well by both conventional and advanced water treatment systems, except for DBP in the case of a conventional water treatment system by chlorination, coagulation/sedimentation and filtration. DEHP was removed by coagulation/sedimentation, rapid sand filtration and activated carbon filtration, but not by chlorination or ozonation. DBP was removed by rapid sand filtration, without chlorination before that, and activated carbon filtration. Figure 1 shows the removal of DEHP and DBP by rapid sand filtration. Rapid sand filtration could remove DEHP very well, but the reason is no clear. Contrarily, BPA and NP were removed by chlorination and ozonation. Figure 2 shows the removal of BPA and NP by ozonation.

Bisphenol A and nonyl phenol could easily be reduced by chlorination. We obtained the same result in a previous laboratory experiment. However, we have found in another laboratory experiment that chlorination by-products are formed as the result, and a bisphenol A solution after chlorination has an estrogenic activity higher than that of the original bisphenol A solution. We also found, in this pilot plant experiment, the formation of 2,2',6,6'-bisphenol A, one of the chlorination by-products of bisphenol A which has a high estrogenic activity.

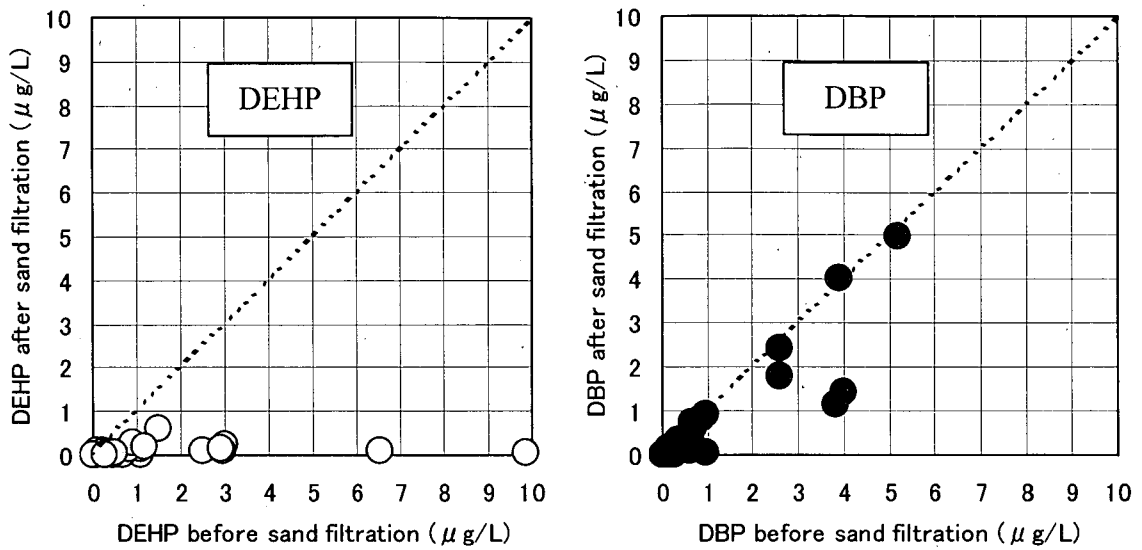

Figure 1 Removal of DEHP and DBP by rapid sand filtration

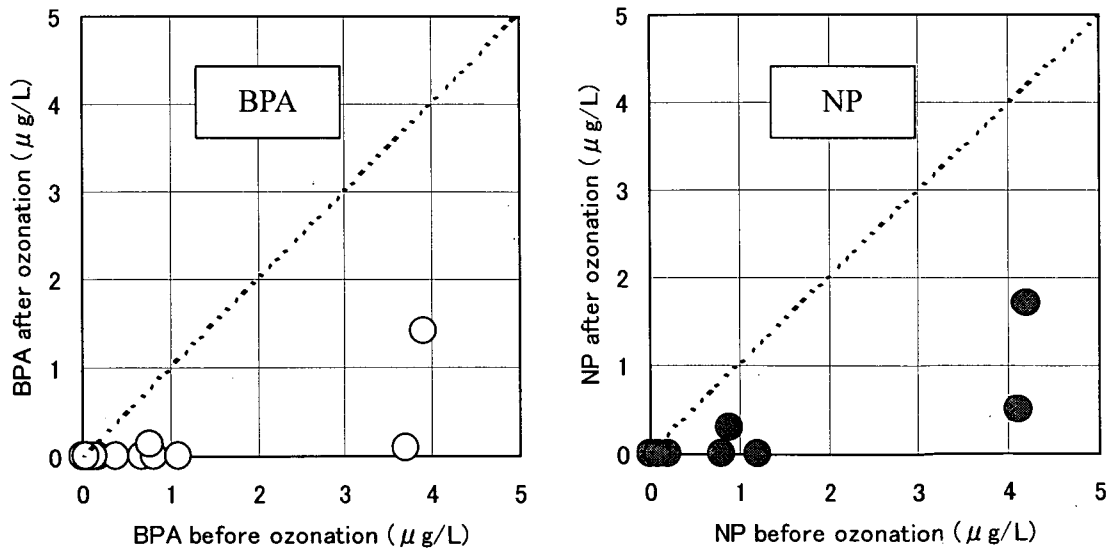

Figure 2 Removal of BPA and NP by ozonation

RELEASE OF EDCS FROM WATER PIPES USED FOR DRINKING WATER SUPPLY

An examination has been conducted using seven types of virgin water pipes in order to obtain information on the long-term profiles of EDC release. The target chemicals were DEHP, DBP, BPA, and NP. Pipes used were two brands of DIP, SGP-V, SGP-P, PE, VP, PEP and XPEP at a diameter of 20-75 mm produced by different manufacturers for each. The EDC release test was repeated several times with a certain interval during a period of two years. Otherwise the pipes were connected to each other in two parallel identical lines and fed with drinking water containing residual chlorine at a concentration of about 1 mg/l continuously. The contact of pipes with test water, pH at 7.0, hardness at 45 mg/l, alkalinity of 35, and residual chlorine at 1.0 mg/l, in the EDC release test was for 16 hours at 23 ± 2 degrees centigrade. We also defined a limit of release determination for each of DEHP, DBP, BPA and NP at 0.4, 0.4, 0.01 and 0.08 $\mu\text{g/l}$, respectively, based on a result of quality assurance measurements.

As the result of a release test at the beginning, DBP was released from almost all pipes tested, but each of DEHP, NP and BPA was released only from a limited number of pipes tested. There was a general trend of decrease in the release of these four chemical compounds. None of these compounds were released from any pipe tested after one year. However, the release of BPA and DBP were found after one and half years and after two years, respectively. The maximum concentrations of DEHP, DBP, BPA and NP were 2.1 $\mu\text{g/l}$ (11.0 $\mu\text{g/m}^2$), 2.2 $\mu\text{g/l}$ (11.0 $\mu\text{g/m}^2$), 0.54 $\mu\text{g/l}$ (2.7 $\mu\text{g/m}^2$) and 2.3 $\mu\text{g/l}$ (12.0 $\mu\text{g/m}^2$), respectively. All of the maximum values were found for virgin pipes, i.e. after 0 months.

CONCLUSIONS

The conclusions of our studies on EDCs in drinking water are as follows:

1. DEHP, DBP and BPA frequently occurred in raw water for drinking water supply.
2. The maximum concentrations of DEHP, DBP and BPA were 0.53, 0.65 and 0.23 $\mu\text{g/l}$ in raw water and 0.26, 0.18 and <0.01 $\mu\text{g/l}$ in treated water, respectively.
3. DEHP, BPA and NP could be removed by both conventional and advanced water treatment systems very well. The profiles of removal of DEHP, DBP, BPA and NP in water treatment processes were different from each other depending on their chemical property.
4. Water pipes used for drinking water supply released DEHP, DBP, BPA and NP depending on the type of pipe material especially when they were newly installed, but the release did not last for a long time.

18. ENDOCRINE DISRUPTORS IN SEWAGE TREATMENT PLANTS

Summary of three-year nationwide survey and recent research at PWRI

Presenter

Dr. Hiroaki Tanaka, Public Works Research Institute

ENDOCRINE DISRUPTORS IN SEWAGE TREATMENT PLANTS

Summary of three-year nationwide survey and recent research at PWRI

H. Tanaka*, K. Komori*, H. Tamamoto*, N. Miyamoto*, T. Higashitani*, and C. Sato**,

**Public Works Research Institute(PWRI)*

***College of Engineering, Idaho State University*

Abstract

The field study on suspected endocrine disruptors (EDs) was conducted at 47 municipal sewage treatment plants (STPs) in Japan. Either composite or grab samples were collected at the STPs, and analyzed for EDs and related substances. Estrogen-like activities (estrogenicities) of sewage and treated sewage were determined using a DNA recombinant yeast strain containing build-in estrogen receptors. The suspected EDs commonly found in influent sewage and effluent of the secondary treatment process include nonylphenol, bisphenol, 2,4-dichlorophenol, 2-ethylhexyl phthalate, di-2-ethylhexyl adipate, benzophenone, 17 β -estradiol, and nonylphenol ethoxylates. These substances in influent sewage were removed to some extent in the primary and secondary treatment processes. Farther reduction of the concerned substances was observed in the advanced treatment processes including sand filtration, ozonation, activated carbon adsorption, and membrane filtration/reverse osmosis (MF/RO) filtration. The chemicals of concern (COC), suspected EDs and related substances, remaining in sludge produced in the STPs appear to be decomposed in an incineration process, as their concentrations in ash were below their detection limits. The results of the yeast assays indicate that the estrogenicity of sewage can be reduced effectively in the municipal STPs, and that approximately one quarter of the observed estrogenicity is associated with 17 β -estradiol and estrone present in the influent sewage and with estrone in the final discharge. The COC concentrations and their estrogenic potential suggest that estrone, 17 β -estradiol and nonylphenol are more important compounds among the COC studied in the nation-wide survey. In many of the STPs studied, however, there are some differences between the estrogenicity determined using the yeast assays and the estrogenic effects estimated from the concentrations of COC and their estrogenic potentials. These differences and results from our fractionation study imply presence of unidentified estrogen-like substances in the influent sewage as well as in the treated sewage. Male-carp breeding experiments were conducted by PWRI with secondary effluent from a sewage treatment plant. Results from these experiments indicate induction of vitellogenin in their blood, but this induction was not observed regularly, suggesting that this phenomenon might be dependent upon the balance between the extents of endogenous and exogenous hormone activity.

Key words: endocrine disruptors, estrogenicity, 17 β -estradiol, estrone, sewage treatment plants

1. Introduction

Rivers and streams carry domestic wastewaters and a number of substances released as products of various human activities in the river basins. In recent years, a new problem has emerged in our water environment, namely endocrine disruptors (EDs) that may adversely affect the reproductive functions of human beings and wild life. The UK Environment Agency conducted research on the effects of EDs on fish in many English rivers, and addressed their potential problems in their rivers⁽¹⁾. Immediately after the UKEA⁽¹⁾ reported their findings, the Ministry of Land, Infrastructure and Transport (MLIT, previously the Ministry of Construction) of Japan acted by classifying the EDs problem as an emergency issue of the environment that requires immediate actions to deal with the problem. Since there were very few studies on the impacts of EDs in the water environments, MLIT determined that real situations of

Japanese rivers and sewerages must be immediately evaluated and that a nationwide fact-finding study must be conducted jointly with the Japan Environmental Agency (JEA).

The estrogenic effects by the discharges from sewage treatment plants (STPs) are of great concern because feminization of male fish downstream of STPs has been reported in England and the United States.^(1,2,3,4) The discharges from industries⁽⁵⁾ and agricultural activities⁽⁶⁾ have been reported to cause feminization of male fish. As a first step, MLIT decided to focus on nationwide surveys on EDs that might be released into water bodies from domestic and industrial activities.⁽⁷⁾ From FY1999 to FY2001, a sewerage study was conducted at 47 STPs, aiming at clarifying the present state of EDs in urban wastewaters. The urban wastewater streams have been thought to be one of the key routes for EDs to enter the water environment. In this paper, we first summarize the state of EDs including suspected EDs and related substances as chemicals of concern (COC), found in sewage. The initial findings reported herein are primarily based on the above-mentioned surveys conducted by MLIT. Then, we analyze the fate of COC in the STPs and the effectiveness of the STPs to remove such compounds. Based on results of the DNA recombinant yeast assay (the YES assay), we examine the estrogen-like activities of untreated sewage and sewage treated to a varying degree in the STP. Finally, we summarize our recent findings on: a) improvement of the ELISA method for 17 β -estradiol in sewage; b) estimation of substances causing estrogen-like activity based on the fractionation method; and c) male-carp breeding experiments with secondary effluent of a STP.

2. Methods and Nationwide Survey

2.1 Sewage treatment plants studied

The three-year study was conducted in the cooperation with the city of Tokyo, five prefectures (Ibaraki, Saitama, Shiga, Kyoto, Osaka), and nine major cities (Sapporo, Sendai, Kawasaki, Yokohama, Nagoya, Kyoto, Osaka, Kobe, Fukuoka). In FY1998, the surveys were conducted at total 27 STPs. These surveys covered 10 STPs in summer, 20 STPs in fall, and 19 STPs in winter. The FY1999 surveys were performed at 38 STPs: 3 STPs were studied in spring, 35 STPs in summer, and 31 STPs in fall. In FY2000, the surveys were conducted at 20 STPs covering 10 STPs in summer and 20 STPs in fall. Total 47 STPs were studied over 3 years.

2.2 Chemicals of concern

In May 1998, Japan Environment Agency⁽⁸⁾ released the document titled "The Strategic Programs on Environmental Endocrine Disruptors '98" (SPEED '98) that lists approximately 70 chemicals as the substances suspected to have endocrine disrupting effects. The SPEED '98 gives the following specific approaches: 1) Promotion of investigations and surveillance for the pollution with EDs, sources of EDs, and adverse effects of EDs on wildlife and human beings; 2) Promotion of development of research and testing methods; 3) Promotion of environmental risk assessment and management; and 4) Strengthening of international networks.

In the first year of this study, 25 chemicals were chosen as COC from the SPEED '98 list. The selected compounds are suspected EDs⁽⁸⁾ and those that might be discharged in sewage because of possible usages in households and/or industries. The selected COC include polychlorinated biphenyls (PCBs), polybrominated biphenyls (PBBs), alkylphenols (4-t-butylphenol, 4-n-pentylphenol, 4-n-hexylphenol, 4-n-heptylphenol, 4-t-octylphenol, 4-n-octylphenol and nonylphenol), bisphenol A, 2,4-dichlorophenol, phthalates and adipate (diethyl phthalate, dipropyl phthalate, di-n-butyl phthalate, dipentyl phthalate, dihexyl phthalate, butyl benzyl phthalate, di-(2-ethylhexyl) phthalate, dicyclohexyl phthalate and diethylhexyl adipate), aromatic compounds (benzo(a)pyrene, benzophenone, 4-nitrotoluene, octachlorostyrene, styrene dimmer, styrene trimer), and VOC (n-butylbenzene). The second-year study focused on 11 chemicals, which were chosen because they exhibited high occurrences in the first year study and their concentrations in influent sewage exceeded their quantification limits (QLs). In the third year, 6 compounds were selected as COC, including nonylphenol, bisphenol A, and di-2-ethylhexyl phthalate, benzophenone, nonylphenol ethoxylates, and 17 β -estradiol. These compounds were chosen because of their high occurrences and difficulty in removing from wastewaters.

In our study, in addition to the EDs selected in SPEED' 98, nonylphenol ethoxylates and 17 β -estradiol were included because the former compounds have been reported to produce nonylphenol and the latter is one of female hormones derived from human and animals. Nonylphenoxy acetates, estrone, and ethynyl estradiol were also investigated based on the facts that nonylphenoxy acetates are suspected to produce nonylphenol, estrone is natural

estrogen, and ethynyl estradiol is contraceptive substance. The analytical methods and their QLs for COC in the sewerage studies are summarized in Table 1.

Table 1. Principal methods for the analysis of endocrine disrupting chemicals used in the sewerage study

Substance	Analysis Method Principles		Minimum Quantification Limit	
	Water Sample	Sludge	water ($\mu\text{g/L}$)	sludge ($\mu\text{g/kg-dry}$)
4-n-octylphenol 4-t-octylphenol 4-t-butylphenol 4-n-pentylphenol 4-n-hexylphenol 4-heptylphenol Nonylphenols	After extraction with dichloromethane, it is cleaned-up with a silica-gel column (dichloromethane elution), dewatered and concentrated, then measured with a GC/MS-SIM	After Soxlet extraction, it is added to water. Then, it is solid-phase extracted, dewatered, concentrated and cleaned-up with a silica-gel column. After quantified with hexane, it is concentrated and measured with GC/MS-SIM and IS methods.	0.3	0.5
Di-2-ethylhexyl phthalate			0.6	5
Butyl benzyl phthalate BBP Di-n-butyl phthalate DBP Diethyl phthalate Dipropyl phthalate Dipentyl phthalate Dihexyl phthalate Dicyclohexyl phthalate	After sodium chloride is added to it to extract with hexane, it is cleaned-up with a flori-gel column, concentrated and dewatered with a nitrogen draft, then measured with a GC/MS-SIM using surrogate standards	After supersonic-extracted with acetonitrile, it is dewatered, concentrated, cleaned up with a GPA column. Then, it is concentrated and measured with GC/MS-SIM method using surrogate method.	0.6	1
Di (2-ethylhexyl) adipate Benzo(a)pyrene 4-nitrotoluene	After sodium chloride is added to it to extract the hexane, it is cleaned-up with a silica-gel column, concentrated and dewatered with a nitrogen draft, then measured with a GC/MS-SIM. In addition a surrogate standard was used.		0.03	
Benzophenone		After supersonic-extracted with acetone, it is extracted with hexane after addition of sodium chloride. Then, it is dewatered, concentrated, and cleaned up with a silica-gel column. Finally, it is concentrated and measured with GC/MS-SIM and IS methods.	0.03	0.5
Bisphenol A 2,4-dichlorophenol	After extracted with dichloromethane, dewatered and concentrated, it is converted to TMS and measured with a GC/MS-SIM	After supersonic-extracted with acetone, it is extracted with dichloromethane after addition of sodium chloride. Then, after dewatered and concentrated, cleaned up with a silica-gel column, it is TM-derivatived and measured with GC/MS-SIM and IS methods.	0.03	0.5
Styrene dimer and trimer 1,3-diphenylpropane,2,4-diphenyl-1-buthan,cis-1,2-diphenylcyclobutane,trans-1,2-diphenylcyclobutane,2,4,6-triphenyl-1-hexene,1a-phenyl-4a-(1'-phenylethyl)tetrarine,1a-phenyl-4e-(1'-phenylethyl)tetrarine,1e-phenyl-4a-(1'-phenylethyl)tetrarine,1e-phenyl-4e-(1'-phenylethyl)tetrarine	After sodium chloride is added to extract it with hexane, it is cleaned-up with a silica-gel column, concentrated and dewatered with a nitrogen draft, then measured with a GC/MS-SIM	After heated-and cycled extraction with 1M KOH-methanol, it is extracted with hexane after addition of sodium chloride solution. It is dewatered, concentrated, cleaned up with a silica-gel column and concentrated. It is measured with GC/MS-SIM and IS methods.	0.03	0.5
n-butylbenzene	Headspace-GC/MS-SIM with Internal standard(IS)		0.3	
octachlorostyrene Poly Brome Biphenyls	After filtered with a glass fiber filter, residual is supersonically extracted with acetone and the extract is added to the filtrate. After extracted with hexane, it is dewatered and concentrated, then measured with a GC/MS-SIM with Internal Standard method.		0.09	

Nonylphenol ethoxylates (n=1~4)	After filtered with a glass fiber filter, residual is supersonically extracted with acetone and the extract is added to the filtrate. After solid-phase extraction, it is eluted and cleaned with a silica-gel column and concentrated, then measured with a HPLC.	After Soxlet extraction with methanol, it is added to water. Then, it is solid-phase extracted, dewatered, concentrated and cleaned up with a silica-gel column. Then, it is concentrated and measured with HPLC.	0.6	3
(n≥5)			0.6	1
Nonylphenoxyacetates nonylphenoxy acetate nonylphenol monoethoxy acetate nonylphenol diethoxy acetate	After filtered with a glass fiber filter, residual is supersonically extracted with methanol and the extract is added to the filtrate. After solid phase extraction, it is methyl-derivatived, and is measured with GC/MS-SIM and internal standard method.		15	
17 β -estradiol(ELISA)	After SPE, the extract is dissolved into DMSO without decomposition of estradiol conjugates and is measured with an enzyme-linked immunosorbent assay (ELISA) kit	After extracted with methanol-acetic acid buffer solution, it is concentrated and added to water. Then, it is solid-phase extracted, dried and dissolved with DMSO. Finally it is measured with ELISA method using a kit by Assay-Design Corp.	0.0006	0.05
Estrogens(LC/MS/MS method) Estrone 17 β -estradiol ethynyl estradiol	After filtered with a glass fiber filter, residual is supersonically extracted with methanol and the extract is added to the filtrate. After solid phase extraction, it is cleaned-up with a froli-gel column and a thin layer chromatogram. Then, it is measured with LC/MS/MS-SIM using internal standard method.		0.0015	

2.3 Sampling locations in sewage treatment plants

Most of the STPs studied employ a conventional activated sludge process, while some apply step aeration, oxidation ditch, as well as advanced treatment for nitrogen and/or phosphorus removal employing coagulant-added activated sludge, circulated nitrification-denitrification process, anaerobic-oxic (AO) process, or anaerobic-anoxic-oxic (A2O) process. The size of the STPs studied ranges from 2,000 to 1,027,000 m³/day. Fig. 1 shows a typical STP and the locations where samples were collected. Grab samples were collected in the first year, while composite sampling was generally applied in the second and third year. The composite samples were collected every three hours for a 24 hour period or collected at every two hours during daytime. The samples were collected from the influent of STP, influent and effluent of the primary settling tank, effluent of the final settling tank, and final effluent discharge following disinfection. Some of the STPs apply physicochemical processes as tertiary treatment, including rapid filtration, ozonation, activated carbon absorption, membrane filtration using micro-filtration (MF), or reverse osmosis (RO) aiming at reclamation and reuse of treated wastewater. In the physicochemical processes, samples were collected from the influent and effluent of each unit process. Sludge generated in the primary and final settling tanks, thickened sludge, anaerobically digested sludge, dewatered sludge, and ash from incinerator, were also collected.

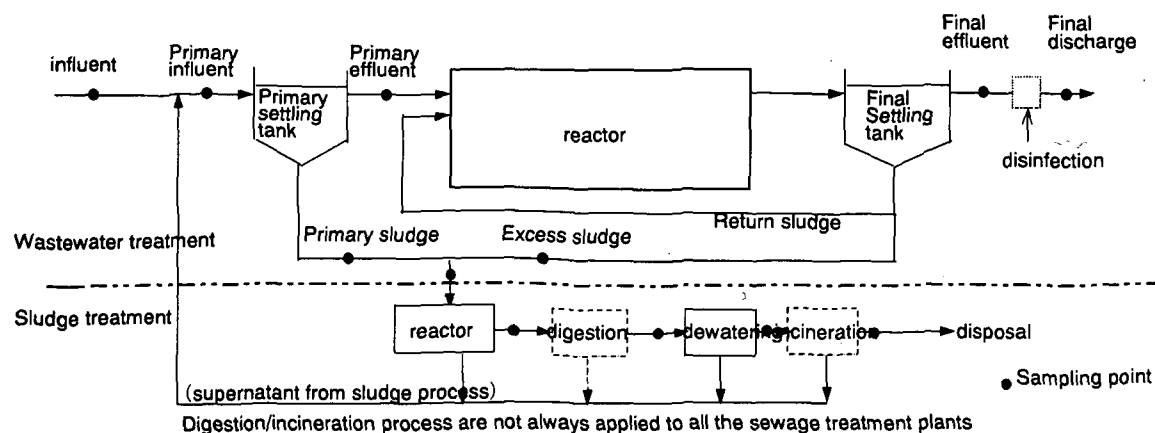

Fig. 1. Sampling points in Sewage Treatment Plants

2.4 Yeast estrogen screen assay

Substances that exhibit estrogenic activities in sewage are of significant concern. Although a number of such compounds are identified in the SPEED'98,⁽⁸⁾ actual number of EDs present in the environment are unknown. At present, existing knowledge on EDs in a sewage treatment system is limited to develop a sound basis for planning to prevent their adverse effects. Therefore, efforts have been made to increase our understanding of these compounds. In this study, we evaluated the estrogen-like activities of untreated and treated sewage using DNA recombinant yeast provided by the courtesy of Prof. Sumpter, Brunel University in England.⁽⁹⁾ In the DNA recombinant yeast, a human estrogen receptor gene is integrated into the yeast's genome in the nucleus and forms estrogen receptor elements. The estrogen receptor in the yeast is reactivated in binding with estrogen-like substances and the ligand-binding receptor unit expresses a reporter gene, *Lac-Z*, on the plasmid in the yeast. Then, β -galactosidase is produced due to the expression of *Lac-Z* and is secreted out of the yeast. The β -galactosidase produced under the series of reactions can change yellow color of a chromogenic agent, chlorophenol red- β -D-galactopyranoside (CPRG), into red. Because production of β -galactosidase in the medium depends upon the amount of estrogen-like substances, measurement of absorbance by a spectrophotometer can estimate the amount of estrogen-like substances in the assay medium. This estrogen detection assay is named as the yeast estrogen-inducible expression system or YES,⁽¹⁾ and is applicable to sewage samples.^(1,10,11,12,13) The YES assay protocol used in this study basically followed Yakou *et al.*⁽¹²⁾ and Tanaka *et al.*⁽¹³⁾ In brief, one liter of each sample was collected and pre-filtered with a glass fiber filter, GF/B, having approximately 1- μ m pores. The filtrate was extracted with a C18 solid phase extraction (SPE) cartridge (500 mg) that had been finished by conditioning and dewatered. Then the C18 SPE cartridge was eluted with 10 mL of methanol. The GF/B filter having suspended matters was also supersonic-extracted. Both the extracts were mixed and condensed into approximately 1 mL with a rotary evaporator. Then the methanol solution was purged by nitrogen gas and was dried. The residuals were dissolved in 100 μ L of DMSO, and used for the estrogen assay in dilution. The relative estrogenic strength of each sample was evaluated from EC50 estimated from its dose-response curve at the same absorbance of 17 β -estradiol. The 17 β -estradiol equivalent of the original sample can be estimated as the EC50 of 17 β -estradiol divided by the EC50 of the test sample at a given concentration factor.

3. Results of chemical-based study

3.1 Concentrations in sewage treatment plants

3.1.1 Influent sewage concentration

For the 34 substances (suspected EDs and related substances) found in sewage in the influent of the STPs, the maximum concentration, 75th percentile, 50th percentile (median), minimum concentrations, and detection limit (DL) of each substance are presented in Fig. 2. Among the substances listed in SPEED '98, 10 were found below their DLs at all the STPs studied, while 15 substances were observed above their QLs in sewage in at least one of the STPs. These 15 substances are 4-*t*-butylphenol, 4-*n*-octylphenol, 4-*t*-octylphenol, nonylphenol, bisphenol A, 2,4-dichlorophenol, diethyl phthalate, di-*n*-butyl phthalate, di-2-ethylhexyl phthalate, butylbenzyl phthalate, benzo(a)pyrene, di-2-ethylhexyl adipate, benzophenone, styrene dimers and trimers, and *n*-butyl benzene. Substances (EDs and related substances) that are not listed in SPEED '98 but were identified at levels greater than their QLs include nonylphenol ethoxlates, nonylphenol ethoxy acetates, 17 β -estradiol, and estrone. Ethynyl estradiol was not found at any sewage treatment plants. Nonylphenol, di-ethyl phthalate, di-2-ethylhexyl phthalate and benzophenone,

nonylphenol ethoxylates, nonylphenol ethoxy acetate, 17β -estradiol (measured by ELISA or LC/MS/MS method), and estrone were identified in all the STPs at levels greater than their QLs. Among alkylphenols, nonylphenol was identified most frequently and at the highest levels. Nonylphenol, nonylphenol ethoxylates, and nonylphenol ethoxy acetates existed on the order of 1 to 1000 $\mu\text{g/L}$. Bisphenol A existed on the order of 0.1 to 10 $\mu\text{g/L}$. Among the phthalate esters, di-2-ethylhexyl phthalate, diethyl phthalate, di-*n*-butyl phthalate, and butylbenzyl phthalate existed at relatively high concentrations. Among estrogens, 17β -estradiol analyzed using the ELISA method was most frequently observed, and its concentration was one order of magnitude larger than the same substance analyzed using LC/MS/MS. This higher detection is likely due to cross-reactions of other substances that are similar to the structure of 17β -estradiol in ELISA kit.⁽¹⁴⁾ Estrone existed in sewage more prevalently than 17β -estradiol on the basis of the data obtained by LC/MS/MS. As the concentrations of the estrogens range from few ng/L to 100 ng/L, the variation of the estrogens are relatively smaller than the other man-made substances used in industry or households. It is elucidated by many researchers⁽¹⁵⁾ that nonylphenol ethoxylates are degraded to nonylphenol acetic acetate and to nonylphenol under anaerobic conditions. Assuming that the nonylphenol precursors have the potential to produce nonylphenol, nonylphenol and its related substances are expressed in terms of nonylphenol-equivalent unit (in mole unit). Based on the nonylphenol-equivalent unit (median values), the distribution of nonylphenol and its related substances is following: nonylphenol, 3%; nonylphenol ethoxylates, 33%; and nonylphenol ethoxy acetates, 64%. Note that nonylphenol contributes only small fraction (3%) of total nonylphenol-equivalent. Among estrogens that were measured by LC/MS/MS, the concentration of estrone was 4 times greater than that of 17β -estradiol (based on their median values).

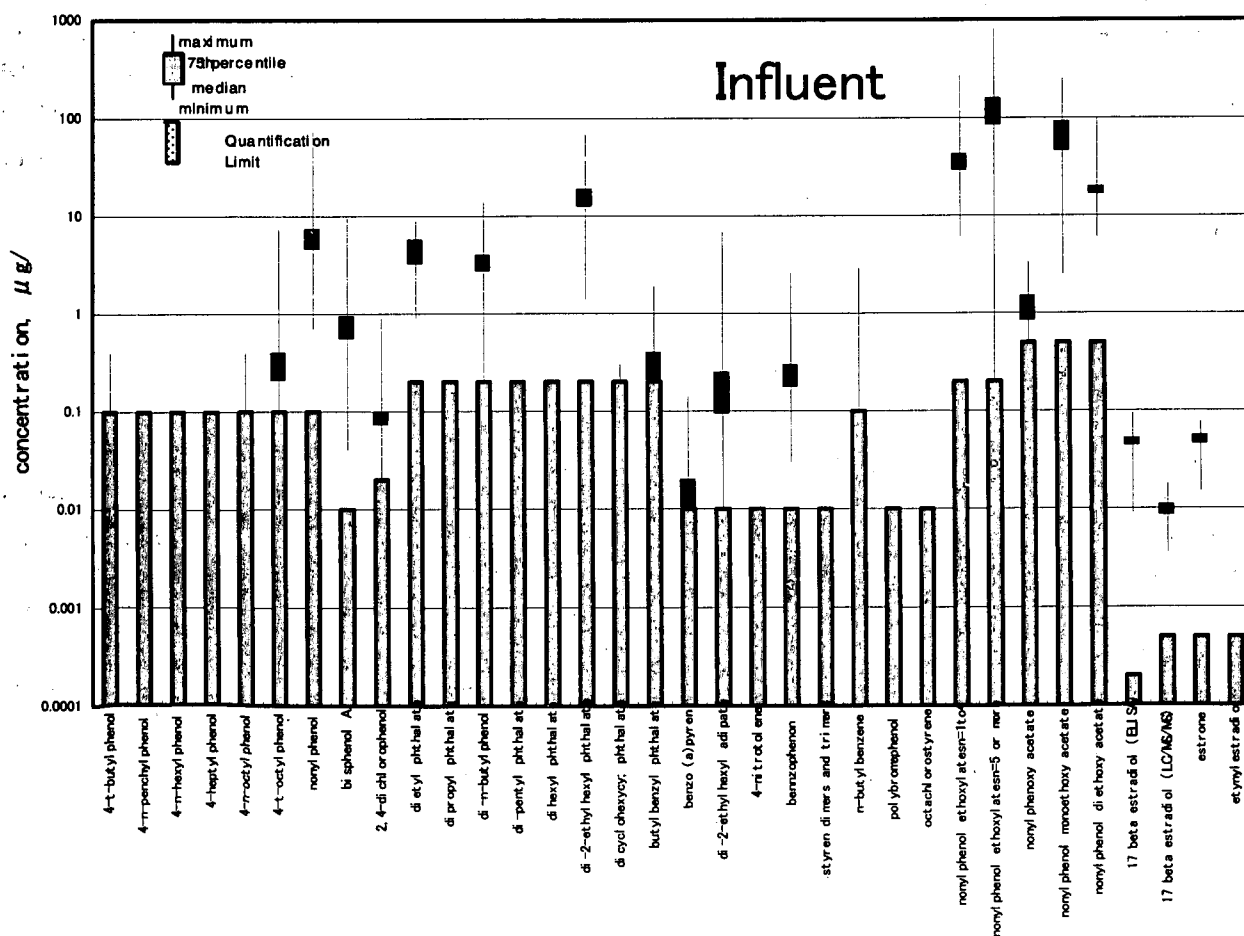

Fig. 2. Influent concentrations of suspected EDs expressed in terms of range and percentiles

3.1.2 Final discharge concentration

In the final effluent of the STPs studied, 18 COC were below their DLs at all the STPs, and 8 COC were above their QLs at least one of the STPs. The COC detected above their QLs include 4-*t*-octyl phenol, nonylphenol, bisphenol A, 2,4-dichlorophenol, di-*n*-butyl phthalate, di-2-ethylhexyl phthalate, di-2-ethylhexyl adipate and benzophenone. Nonylphenol ethoxylates, nonylphenol ethoxy acetates, 17 β -estradiol (measured with the ELISA or LC/MS/MS methods) and estrone were found in either secondary effluent or final effluent of at least one of the STPs. Ethynyl estradiol was not detected in treated sewage at any STPs. Although the concentrations of nonylphenol in most of the final discharges were approximately 1 μ g/L, the related substances such as nonylphenol ethoxylates and ethoxy acetates existed at one μ g/L to few tens μ g/L. Based on the nonylphenol-equivalent unit (median value), nonylphenol occupies an insignificant fraction of total unit, while nonylphenol ethoxylates occupy 17% and nonylphenol ethoxy acetates constitute 83%. Among estrogens (i.e., estrogen and its related compounds) that were measured by LC/MS/MS, estrone occupies the most part of estrogens and 17 β -estradiol is minimal.

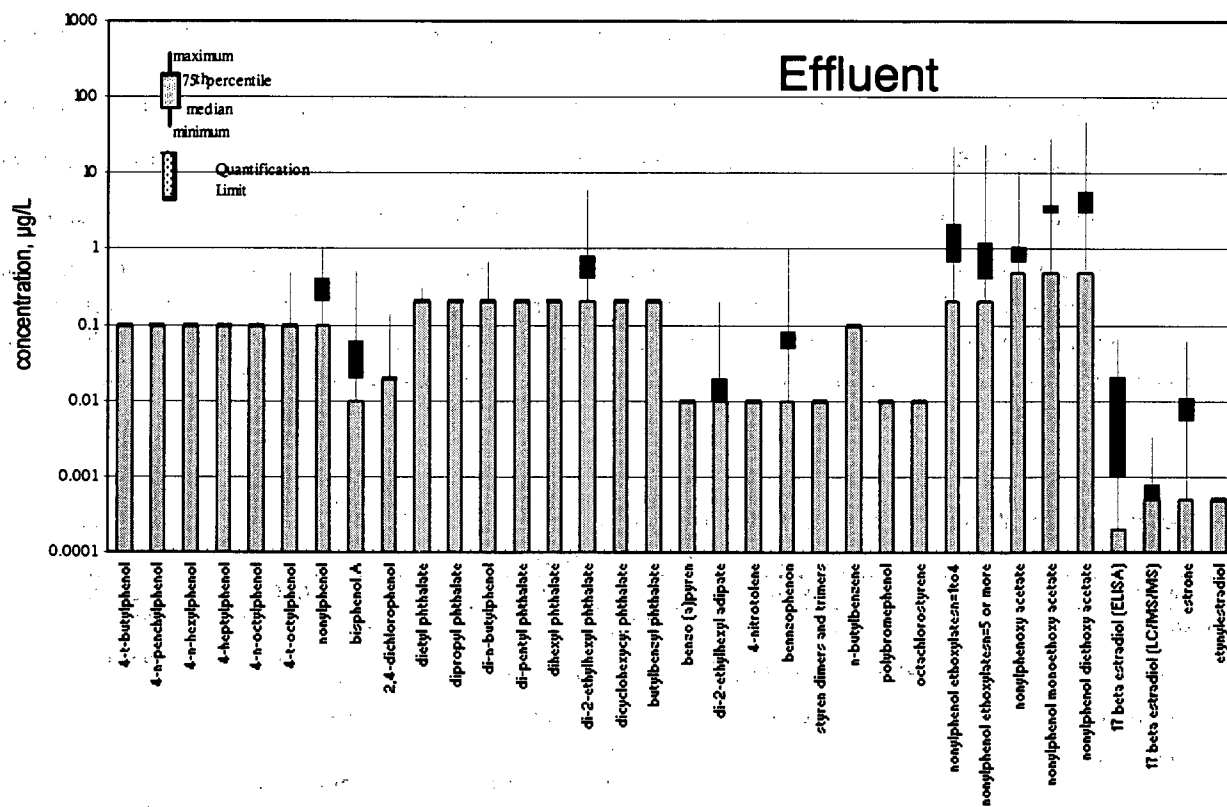

Fig. 3. Final effluent concentrations of suspected EDs expressed in terms of range and percentiles

3.2 Reduction of suspected EDs in sewage treatment plants

The relationship between the influent and effluent concentrations are shown in Fig. 4, in which only the substances with their median concentrations in the influent exceed their QLs are presented. The influent and effluent concentrations are plotted on the abscissa and ordinate, respectively. The linear line represents the removal efficiency (%) of COC. The plot that is closer to the abscissa indicates a greater reduction of COC in the STPs, and the plot closer to the 45-degree line indicates little or no reduction of the substance in the STP. The samples were collected via single grab sampling in the first year and composite sampling in the following two years. The plots show that the reduction trends for the both sampling cases are similar, and that, in some of the STPs, the effluent concentrations of 17 β -estradiol, estrone, and/or benzophenone are nearly the same or above their influent concentrations.

Although the concentrations of COC in influent (sewage) varied, they were consistently reduced in most of the STPs. To develop an understanding of the reduction trends for COC in the STPs, the available data are statistically analyzed and presented in Table 2. For the STPs in which the influent concentration exceeded its QL, we calculated range and median of the removal efficiency for each substance. A parenthesis in Table 2 is the removal efficiency calculated based on median of the influent concentrations and median of the effluent concentrations. The result indicates that most of COC in sewage can be removed in a STP with efficiencies greater than 90% (based on median values), and that STPs in Japan are effective in reducing most of the suspected EDs identified in this study. Three notable exceptions are benzophenone, 17 β -estradiol, and estrone. The removal efficiencies of these compounds (approx. 70-80%) are somewhat smaller than those of other compounds (>90%). Benzophenone, 17 β -estradiol (measured by ELISA or LC/MS/MS) and estrone are scattered in a wide range. At some of the STPs, negative removal efficiencies were obtained for 17 β -estradiol and estrone. This observation may suggest that 17 β -estradiol and estrone could increase in the treatment processes. Nonylphenol ethoxy acetates also tend to increase in the treatment. One plausible explanation for this trend is that these substances can be formed from conjugate-form of estrogens and nonylphenol ethoxylates. Further investigation at existing STPs and controlled experiments in pilot plants and laboratories can permit an explanation of the complex reactions occurring under various operating conditions.

Table 2. Range of removal efficiencies of the substances whose median concentrations exceeded the quantification limits in sewage treatment plants

Substances	FY 1998	FY 1999	FY 2000	Over all
Nonylphenol	76%~99%(94%)	84%~99%(98%)	>82%~>99%(-)	(97%)
Bisphenol A	30%~>99%(95%)	43%~99%(>96%)	>47%~>99%(>96%)	(96%)
2,4-dichlorophenol	50%~>98%(-)	60%~>95%(-)	no data	-
Di-ethyl phthalate	>83%~>98%(-)	>78%~>97%(-)	no data	-
Di-n-butyl phthalate	>75%~>98%(-)	>78%~>99%	no data no data	-
Di-2-ethylhexyl phthalate	61%~>99%(95%)	78%~>99%(>98%)	>47%~>98%(>94%)	97%
Di-2-ethylhexyl adipate	~>99%(-)	40%~99%(-)		-
Benzophenone	83%~>99%(65%)	~>98%(-)	>50%~>97%(89%)	71%
Nonylphenol ethoxylate (n=1~4)	66%~>99%(94%)	60%~>99%(98%)	52%~>99.5%(95%)	97%
Nonylphenol ethoxylate (n \geq 5)	83%~>99%(99%)	86%~>99%(99.5%)	>98%~>99.9%(-)	>99%
17 β -estradiol(ELISA)	~>99%(67%)	~>99%	15%~>99%(79%)	77%
17 β -estradiol(LC/MS/MS)	no data	no data	-160%~>96%(-)	-
estrone	no data	no data	-80%~>99%(86%)	86%

*When values in final discharge are below the detection limits (DLs), they are assumed to be the DLs and indicates ">XX%". When values in final discharge are over DLs and below the quantification limits (QLs), they are assumed to be estimated concentrations. If the influent concentration is less than QLs, the data are not used for calculation of removal efficiency. In both the cases reduction efficiencies are expressed in more than (>) the calculated ratios. When the influent concentrations are below quantification limits, the reduction efficiencies are not calculated. "-" means the influent concentration is below QL or final discharge is below DL. "(" means removal efficiency that is based on medians of influent and final discharge.

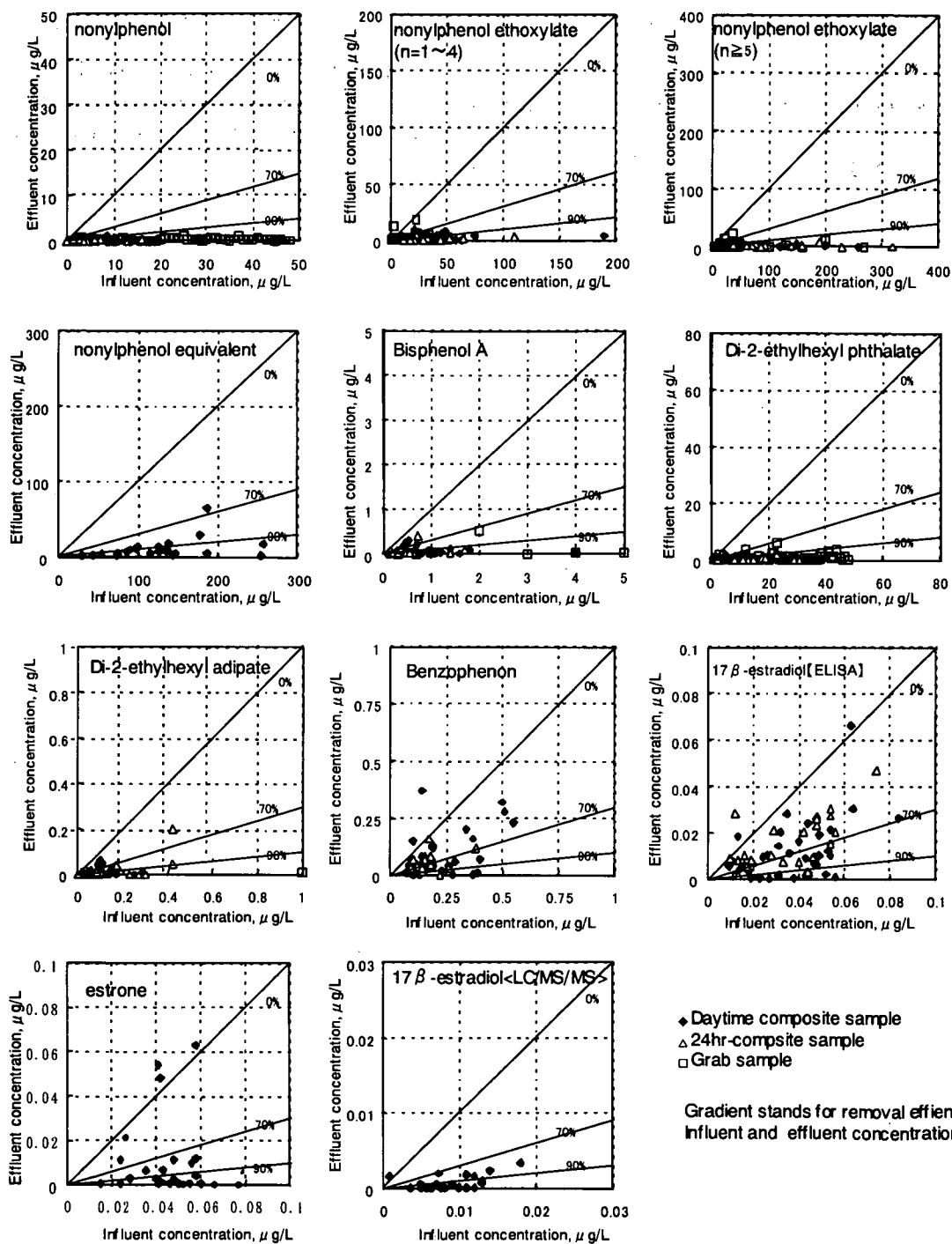

Fig. 4. Relationship between the influent and the final discharge concentrations of selected EDs in sewage treatment plants in Japan

3.3 Change in concentration during secondary treatment.

A typical STP consists of primary settling tanks, biological reactors (activated sludge process), secondary settling tanks, and disinfection units, in sequence. The suspected EDs in sewage, influent and effluent of the primary treatment, and final discharge were analyzed at the 34 STPs for 3 years. All the data obtained are statistically analyzed, and the 25th and 75th percentiles (rectangular box), ranges (error bar), and medians (black dot) are presented in Fig. 5. In the primary treatment, most of COC were reduced effectively, while some of them were reduced less effectively. For instance, benzophenone and 17 β -estradiol (measured using ELISA) exhibited little reduction in the primary treatment. On the other hand, all of COC were removed more effectively in the biological treatment (aeration tank) than in the primary treatment. Overall, the substances we investigated appear to be removed in the primary treatment and/or the secondary (biological) treatment. To gain a further understanding of their reduction mechanisms and fates, more detailed and extensive investigations in the field and laboratory are necessary.

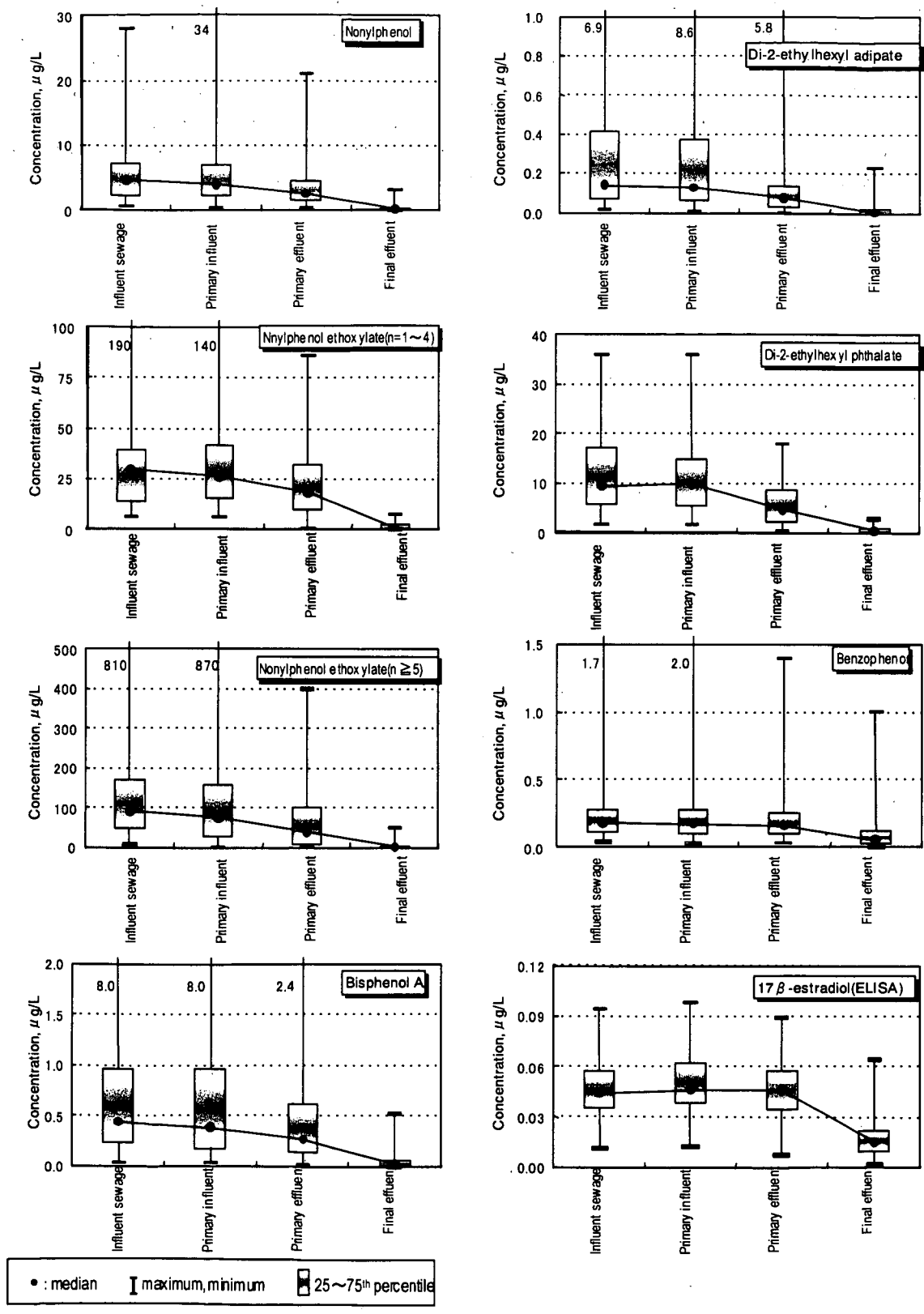

Fig. 5. Concentrations of suspected EDs in the sewage treatment plants.

Figs. 6 and 7 show plots of the removal efficiencies (%) against the aerated solids retention time (A-SRT) and the hydraulic retention time (HRT), respectively, for the suspected EDs. The plots reveal that the removal efficiencies of the concerned substances vary considerably in the STPs where A-SRT and/or HRT is small (approx. <15 days), and that the extent of the variation reduces to the higher efficiencies in the STPs with larger A-SRT (A-SRT >15 days) and/or HRT. Although a limited amount of data is available in the high A-SRT and HRT cases, this observation suggests that the biological treatment process (e.g., biological nitrogen removal process, oxidation ditch) with a large A-SRT or HRT is effective in removing EDs. Due to the limited available data and the differences in the STP's operating variables, this observation cannot be fully verified. Therefore, further studies are necessary.

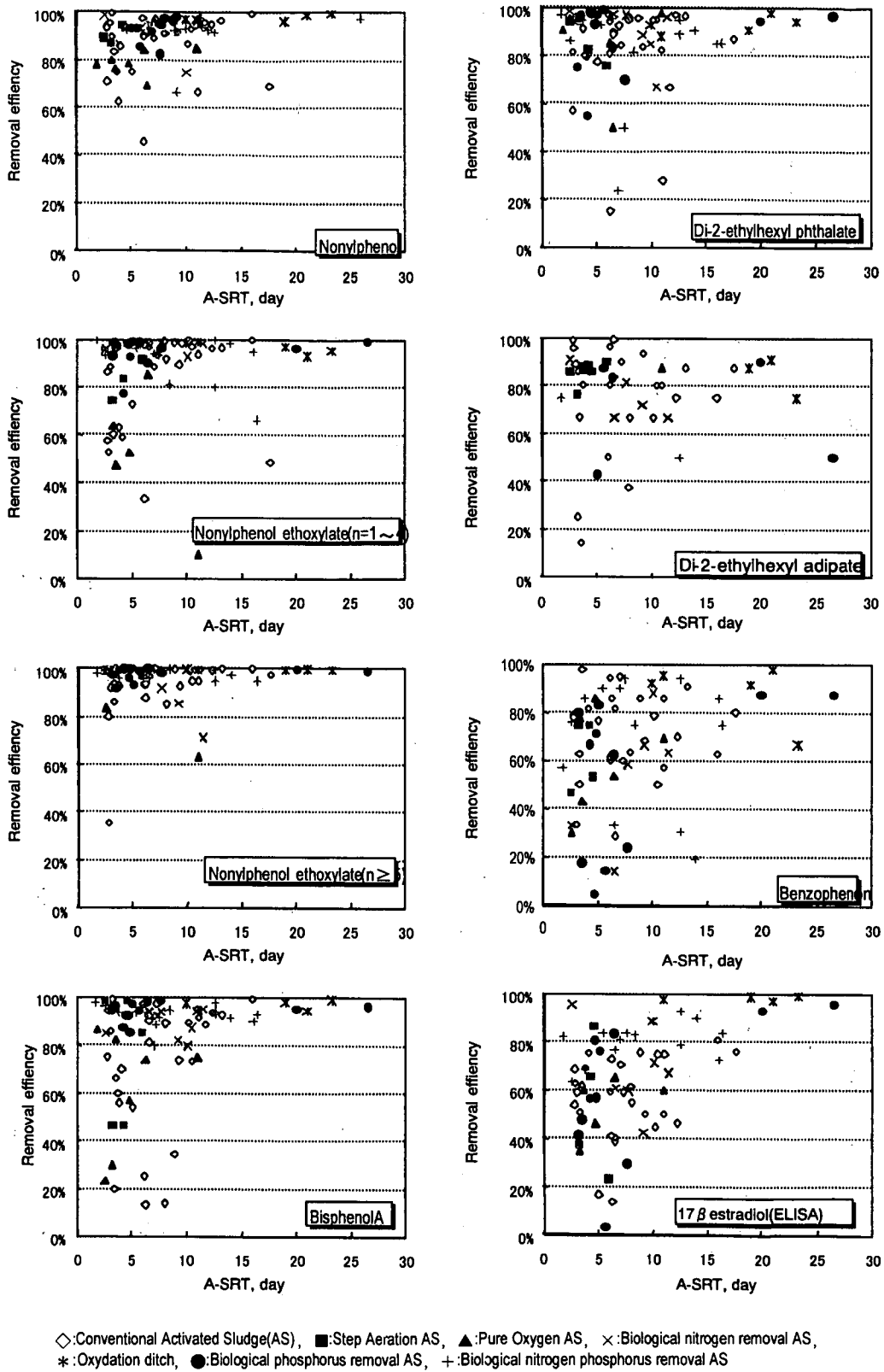
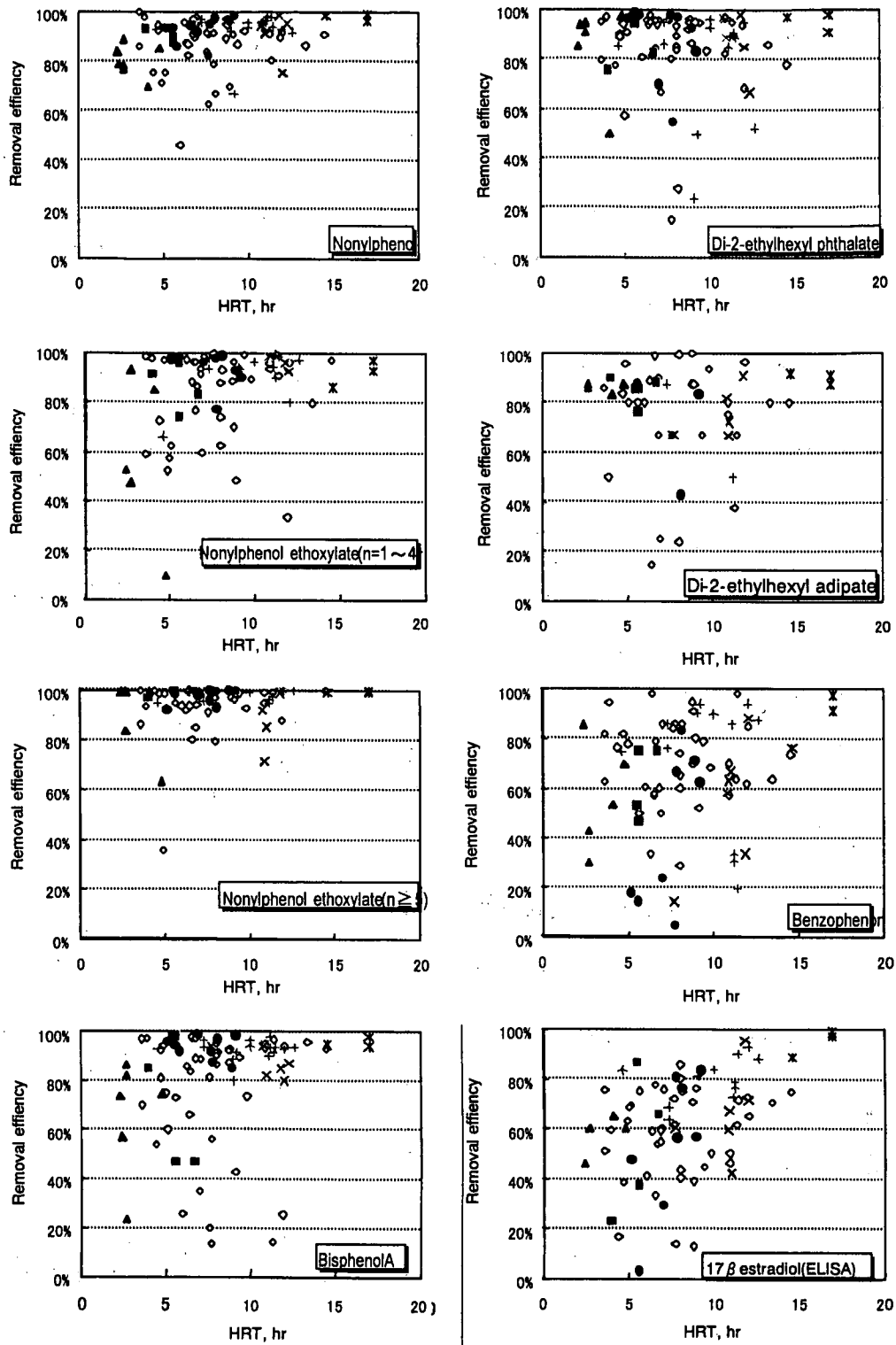

Fig. 6: Removal efficiencies of suspected EDs in the biological treatments with aerated sludge retention time (A-SRT)



◇:Conventional Activated Sludge(AS), ■:Step Aeration AS, ▲:Pure Oxygen AS, ×:Biological nitrogen removal AS,
 *:Oxidation ditch, ●:Biological phosphorus removal AS, +:Biological nitrogen phosphorus removal AS

Fig. 7. Removal efficiencies of suspected EDs in the biological treatments with hydraulic retention time (HRT)

3.4 Reduction in tertiary treatment

Tertiary treatment plants generally apply physicochemical processes following secondary (biological) treatment, aiming at wastewater reclamation and reuse. Thus, effectiveness of the tertiary treatment processes in removing EDs is of great concern. In this study, the physicochemical treatment processes following the biological treatment are evaluated by comparing the COC concentrations in the influent and effluent of each unit process. The processes evaluated in this study include rapid filtration, ozonation, activated carbon absorption, mechanical membrane filtration, and reverse osmosis (RO) membrane processes. As noted earlier, most of COC were below their QLs in the effluent of the biological process. Thus, only the substances that exceeded their QLs in the effluent of the biological process were chosen. Table 3 summarizes the available data using the number of samples that exceeded their QLs and the ranges of the concentrations in influent and effluent of each unit process applied in the tertiary treatment. Examination of Table 3 reveals that the sand filtration process contributes little in reduction of COC. The low COC removal may be resulted from the low suspended solids (SS) reduction by the sand filtration. Because SS in the secondary effluent is generally low, the removal of SS by the sand filtration is minimal. On the other hand, ozonation, activated carbon absorption, and RO membrane processes can contribute to some degrees of COC reduction as their concentrations in the effluent are somewhat lower than those in the influent of the process. Although many of COC are seen to be removed in the physiochemical treatment processes (following the biological treatment), the several compounds including benzophenone, nonylphenol ethoxylate, nonylphenol ethoxy acetates, 17β -estradiol, and estrone tend to remain in the tertiary effluent above their QLs.

Unit: SS and COD are mg/L, the others are μ g/L

Table 3 Change of substance concentrations in specific physicochemical treatment processes after biological treatment

substances	Quantification limit	Sand filtration		ozonation		Activated carbon absorption		Membrane Filtration		Reverse Osmosis Membrane	
		influent	effluent	influent	effluent	influent	effluent	influent	effluent	influent	effluent
SS	1	<1~8 (27/30)	<1~4 (7/30)	<1~3 (2/7)	<1~1 (1/7)	<1 (0/2)	<1 (0/2)	<1 (0/1)	<1 (0/1)	-	-
COD	1	5.4~10 (13/13)	4.7~9.7 (13/13)	4.7~11 (15/15)	3.1~9.7 (15/15)	6.0~6.3 (2/2)	3.8~4.9 (2/2)	7.7 (1/1)	6.1 (1/1)	-	-
nonylphenol	0.3	n.d.~0.3 (1/30)	n.d.~tr(0.2) (0/30)	n.d.~0.6 (2/15)	n.d.~tr(0.2) (0/15)	n.d.~tr(0.2) (0/6)	n.d.~tr(0.1) (0/6)	n.d. (0/1)	n.d. (0/1)	n.d.~tr(0.1) (0/4)	n.d.~tr(0.1) (0/4)
bisphenolA	0.03	n.d.~0.33 (13/30)	n.d.~0.21 (8/30)	n.d.~0.21 (6/15)	n.d.~0.13 (1/15)	n.d.~0.11 (3/6)	n.d.~0.05 (2/6)	n.d. (0/1)	n.d. (0/1)	tr(0.01)~0.09 (1/4)	n.d.~0.04 (1/4)
di-2-ethylhexyl phthalate	0.6	n.d.~1.9 (10/30)	n.d.~2.8 (5/30)	n.d.~2.8 (4/15)	n.d.~0.7 (2/15)	n.d.~tr(0.5) (0/6)	n.d. (0/6)	tr(0.2) (0/1)	n.d. (0/1)	n.d.~1 (1/4)	n.d.~tr(0.4) (0/4)
di-2-ethylhexyl adipate	0.03	n.d.~0.05 (2/16)	n.d.~0.19 (2/16)	n.d.~0.03 (1/8)	n.d.~tr(0.02) (0/8)	n.d. (0/4)	n.d.~tr(0.01) (0/4)	-	-	n.d.~0.01 (0/3)	n.d.~n.d. (0/3)
benzophenon	0.03	n.d.~0.22 (8/15)	n.d.~0.13 (7/16)	tr(0.01)~0.13 (5/8)	n.d.~0.12 (2/8)	n.d.~0.12 (2/3)	n.d.~tr(0.02) (0/3)	tr(0.01) (0/1)	tr(0.02) (0/1)	n.d.~0.03 (1/2)	tr(0.01)~tr(0.02) (0/2)
nonylphenol ethoxylates (n=1~4)	0.6	n.d.~9.1 (9/14)	n.d.~10 (7/14)	n.d.~27 (2/6)	n.d.~1.0 (3/6)	n.d.~1.1 (1/3)	n.d.~tr(0.4) (0/3)	2.1 (1/1)	1.9 (1/1)	0.4~1.4 (1/2)	tr(0.4)~tr(0.5) (0/2)
nonylphenol ethoxylates (n \geq 5)	0.6	n.d.~3.0 (2/14)	n.d.~1.6 (2/14)	n.d.~1.0 (2/6)	n.d.~tr(0.3) (0/6)	n.d.~tr(0.3) (0/3)	n.d.~n.d. (0/3)	n.d. (0/1)	n.d. (0/1)	n.d.~tr(0.2) (0/2)	n.d.~tr(0.3) (0/2)
nonylphenoxyl acetate (NP1EC)	1.5	n.d.~3.8 (2/8)	n.d.~4.3 (1/8)	n.d.~4.8 (1/4)	n.d.~tr(0.8) (0/4)	n.d.~4.3 (1/2)	n.d.~3.6 (1/2)	tr(1) (0/1)	tr(1) (0/1)	-	-
nonylphenol monoethoxy acetate (NP2EC)	1.5	tr(1.4)~5.6 (7/8)	tr(0.8)~7.4 (6/8)	tr(1.3)~22 (3/4)	n.d.~2.3 (2/4)	n.d.~5.9 (1/2)	n.d.~5.1 (1/2)	3.8 (1/1)	3.2 (1/1)	-	-
Nonylphenol diethoxy acetate (NP3EC)	1.5	tr(0.8)~7.8 (7/8)	1.9~11 (8/8)	1.9~19 (4/4)	tr(1.0)~4.3 (2/4)	1.9~4.0 (2/2)	tr(1.1)~3.4 (1/2)	6.7 (1/1)	5.6 (1/1)	-	-
17 β -estradiol (ELISA)	0.0006	0.0012~0.064 (24/24)	n.d.~0.044 (22/24)	n.d.~0.029 (12/13)	n.d.~0.019 (4/13)	n.d.~0.023 (4/6)	n.d.~0.0082 (2/6)	0.026 (1/1)	0.021 (1/1)	0.0012~0.021 (4/4)	n.d.~n.d. (0/4)
17 β -estradiol (LC/MS/MS)	0.0015	n.d.~tr(0.0014) (0/8)	n.d.~0.0025 (1/8)	n.d. (0/4)	n.d. (0/4)	n.d.~0.0025 (1/2)	n.d. ~tr(0.00002) (0/2)	n.d. (0/1)	n.d. (0/1)	-	-
estron (LC/MS/MS)	0.0015	tr(0.0009) ~0.081 (5/8)	n.d.~0.05 (3/8)	tr(0.0011) ~0.0042 (3/4)	tr(0.0005) ~tr(0.0014) (0/4)	tr(0.0008) ~0.05 (1/2)	0.0019~0.01 (1/2)	tr(0.0013) (0/1)	tr(0.0011) (0/1)	-	-

() stands for sample number exceeding quantification limit/total sample number
 - stands for no available data

3.5 Sludge treatment processes

The concentrations of COC in sludges from various processes are summarized in Table 4. The concentrations are expressed in terms of mass of COC per unit mass of dry solid (i g/g). Note that the data sizes differ greatly with varying processes and COC. The COC concentrations in excess sludge from the biological treatment tend to be lower than those in primary sludge. The median concentrations of COC in the incinerated ash are below their DLs, and are the lowest in any sludge types compared herein. It is noteworthy that the median concentration of nonylphenol is larger after the digestion process than the thickening process. As the data are compared among the STPs that apply an anaerobic digestion process alone, the increase in nonylphenol in the digested sludge is apparent. The result supports the previous observations⁽¹⁵⁾ that nonylphenol was produced under the anaerobic conditions.

Table 4 Change of substance concentrations in sludge during sludge treatment processes

	nonylphenol	bisphenol A	di-2-ethylhexyl phthalate	di-2-ethylhexyl adipate	benzophenone	nonylphenol ethoxylates (n=1 to 4)	nonylphenol ethoxylates (n ≥ 5)	17bete estradiol
Primary Sludge								
range	0.7 - 130	nd - 1.5	3.4 - 440	nd - 1.8	nd - tr(0.30)	nd - 210	nd - 74	nd - tr(0.049)
median	6.1	tr(0.28)	86	nd	nd	28	17	tr(0.019)
quantification rate	25/25	6/25	25/25	1/25	0/25	24/25	23/25	0/25
Excess Sludge								
range	nd - 41	nd - 0.63	nd - 230	nd - 7.3	nd	nd - 120	tr(0.3) - 17	nd - 0.12
median	1.4	nd	55	nd	nd	10	2.3	tr(0.023)
quantification rate	36/62	2/62	26/29	1/29	0/29	28/29	23/29	7/29
Condensed Sludge								
range	nd - 64	nd - 0.98	3.8 - 150	nd - 3.1	nd - tr(0.29)	nd - 120	nd - 29	nd - 0.15
median	3.3	tr(0.24)	110	nd	nd	12.0	2.8	tr(0.032)
quantification rate	16/18	3/18	17/17	2/17	0/6	16/17	16/17	6/17
Digestion Sludge								
range	13 - 210	tr(0.22) - 3.2	nd - 200	nd - 1.0	-	tr(0.9) - 21	tr(0.4) - 13	tr(0.020) - 0.064
median	38	0.92	65	nd	-	14	1.8	tr(0.038)
quantification rate	7/7	5/7	6/7	1/7	-	6/7	5/7	2/7
Dewatered Sludge								
range	tr(0.17) - 210	nd - 1.2	nd - 170	nd - tr(0.70)	nd - tr(0.42)	nd - 47	tr(0.3) - 71.0	nd - 0.062
median	6.0	tr(0.29)	97.0	nd	nd	14	9.0	tr(0.008)
quantification rate	21/23	7/23	17/18	0/8	0/8	17/18	16/18	4/18
Incinerated Ash								
range	nd - 0.57	nd	nd	nd	nd	nd	nd	nd
median	nd	nd	nd	nd	nd	nd	nd	nd
quantification rate	1/19	0/19	0/16	0/16	0/6	0/14	0/16	0/16

4. Results of estrogen-like activity

4.1 Estrogenicities in influent and effluent of STPs.

The estrogen-like activities (estrogenicities) of the influent sewage and the final effluent are compared in Fig. 8. The estrogen-like activities of the influent and final discharge of the 34 STPs were measured and expressed in terms of 17 β -estradiol equivalent.^(12,13) Total number of samples measured is 98. The estrogen-like activity of the influent ranges from 0.0099 to 0.82 μ g/L, and its median and mean are 0.077 μ g/L and 0.099 μ g/L, respectively. On the other hand, the estrogen-like activity of the final discharge ranges from 0.0001 to 0.21 μ g/L, and its median and mean are 0.0073 and 0.018 μ g/L, respectively. The removal efficiency ranges from -119% to >99%, and its median and mean are 90% and 91%, respectively. Four samples collected in 3 STPs gave negative removal efficiencies because the estrogen-like activities of the final discharge are higher than those of the influent. Because these samples (from the 3 STPs) were collected as grab samples in the first year, the negative values might not give representative efficiencies occurring in the STPs. The estrogen-like activity was, in general, reduced effectively in most of the STPs studied.

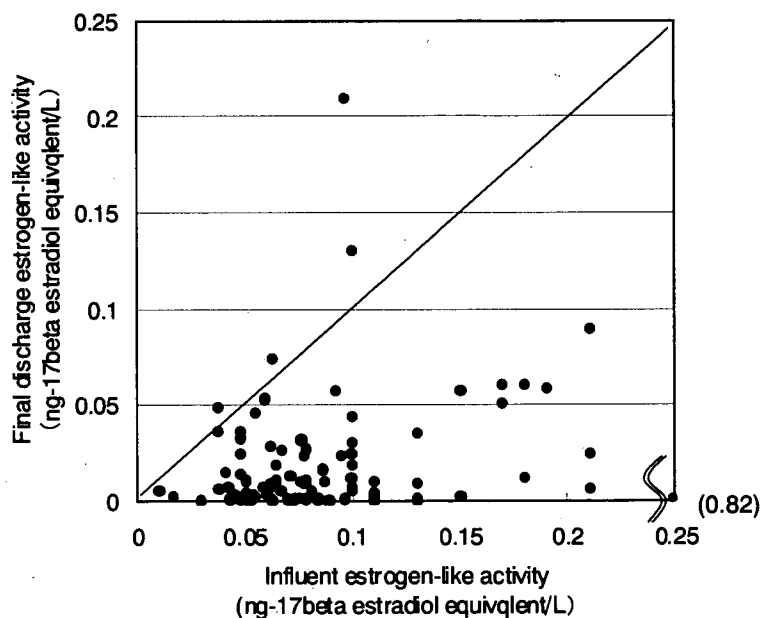

Fig. 8. Estrogen-like activities as 17 β -estradiol equivalent (ng/L) in influent sewage and final discharge

4.2 Change in estrogenicities in sewage treatment.

Estrogenicities of untreated, partially treated, and treated wastewater were investigated at nine STPs. Samples were taken from the sewage influent, influent and effluent of the primary treatment, effluent of secondary treatment (activated sludge process), and final effluent after disinfection. The samples were analyzed for estrogenicity, and results are summarized in Fig. 9 in terms of the range, the 25th and 75th percentiles, median, and average. Three outlying values were removed from the statistical analysis, but are presented in Fig. 9. As is seen, the primary influent samples exhibited the greater estrogenicity than the influent sewage samples. The greater estrogenicity is probably due to the supernatant returned from the sludge treatment process. Note that some of the STPs studied have relatively large sludge treatment facilities that even treat sludge from other STPs in the same municipalities. The estrogenicity in the effluent of the primary treatment is somewhat lower than that in its influent, indicating that the primary treatment can

reduce the estrogenicity to some extent. A dramatic decrease in the estrogenicity is observed in the secondary treatment process in which all the STPs studied use the activated sludge process, except for the 3 STPs which gave 3 outlying values. The results suggest strongly that the estrogenicity can be effectively reduced in the biological treatment processes. A slight increase in the estrogenicity is seen in the final effluent. Because this analysis is based on the data obtained from a single grab sampling occasion (at each sampling location), there is considerable uncertainty concerning interpretation of the results.

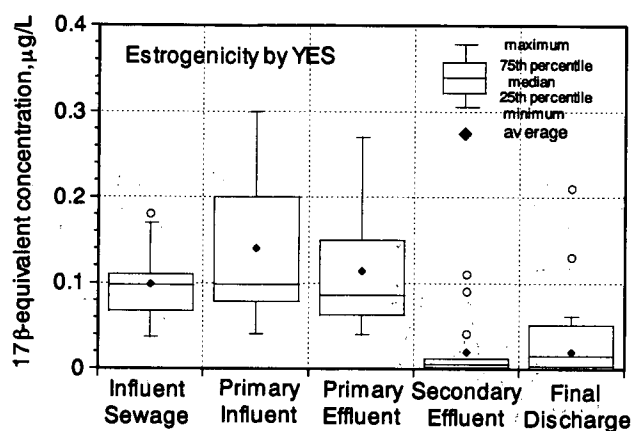

Fig. 9. Change of the estrogenicity in nine sewage treatment plants

5. Discussion

5.1 Gap between estrogen-like activity measured with YES and chemical analysis

In the previous studies,^(12,13) the estrogenic potential by individual substance was measured. In this study, we used the estrogen potential derived in their studies to estimate the estrogen-like activities for the substances concerned in the nationwide study.⁽¹⁶⁾ It is assumed that each substance exhibits estrogenic effect on the yeast independently from other substances, and that the effects by multiple substances are additive. These assumptions are supported by Miyamoto *et al.* (unpublished data). We calculated total estrogen-like activity for each substance based on its estrogenic potential (expressed in terms of 17β -estradiol equivalent) and the concentration of the substance monitored in the nation-wide survey, and called it "theoretical estrogenicity".^(12,13) If the estrogen-like activity obtained by the YES assay adequately expresses total amount of estrogen-like substances, the YES value is generally greater than the estrogenicity calculated using all the substances found in the nation-wide survey. If the relative estrogenic potential (REP) of 17β -estradiol is assumed to be 1, REP for the substances monitored in the nation-wide survey⁽¹⁶⁾ are given as follows: Estrone 0.3; 17β -ethynylestradiol 0.5; 4-tert-butylphenol 0.00002; 4-n-pentylphenol 0.0007; 4-n-hexylphenol 0.0006; 4-n-heptylphenol 0.00006; 4-n-octylphenol 0.000005; nonylphenol 0.001; 4-t-octylphenol 0.02; bisphenol A 0.00006; 2,4-dichlorophenol 0.000002; benzophenone 0.0000006; others have no significant positive data at the concentrations up to 2 g/L.^(12,13)

Fig. 10 shows the theoretical estrogenicities of 17β -estradiol and other suspected EDs along with the observed estrogenicities (measured using the YES assay) for the substances monitored in the nation-wide survey.⁽¹⁶⁾ The samples are numbered in increasing order of the estrogen-like activity. As seen in the samples with the low

estrogen-like activities (<I15, <F23), the calculated estrogenicity of 17β -estradiol accounts for a large portion of the total estrogenicity, leaving little or no room for other ED substances observed in the nation-wide survey. This trend is seen in the both influent sewage and final discharge cases, and supports that the ELISA method may overestimate the concentration of 17β -estradiol in wastewater as was reported in our previous study.^(12,13) On the other hand, in the samples with the larger estrogen-like activity (>I15, >F23), the observed estrogenicity (the YES assay) is considerably larger than the corresponding theoretical value particularly in the influent sewage. The gap suggests the presence of unknown chemicals that are not accounted as substances that would cause estrogenicity.

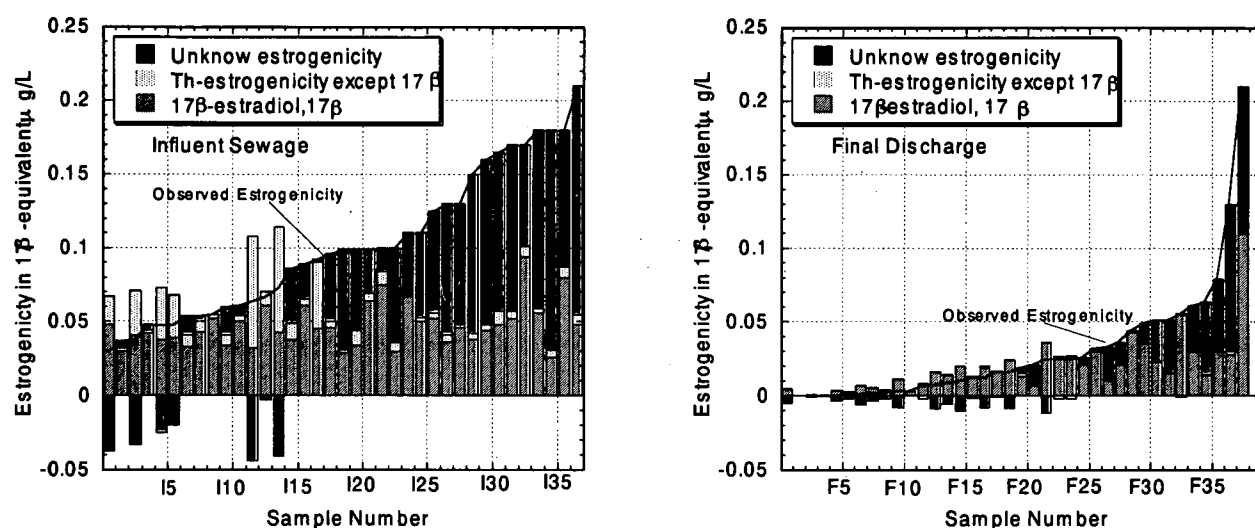

Fig. 10. Estrogen-like activities of influent sewage and final discharge of STPs, calculated based on estrogen data collected using ELISA⁽¹³⁾

In the third year, 13 samples of the influent sewage and the final discharge were analyzed for 17β -estradiol and estrone using LC/MS/MS, in place of the ELISA method. The theoretical estrogenicity was calculated based on the analytical data, and compared with the observed estrogen-like activity (measured using the YES assay). Results of this comparison (Fig. 11) reveal that the observed estrogenicity is larger than the theoretical value in all the influent sewage and final discharge samples except one. Estrone occupies the largest portion of total estrogenicity as compared to other substances. Based on the average data of the 13 samples, the following observations can be made. In the influent sewage, 17β -estradiol, estrone, and other measured chemicals (particularly nonylphenol) contribute, respectively, 10%, 15%, and 3% of total estrogenicity, and the estrogen-like activity derived from unidentified substances accounts for more than 70% of total activity. On the other hand, in the final discharge, 17β -estradiol, estrone, and other measured chemicals (particularly nonylphenol) contribute 2.5%, 22% and 0.5%, respectively, but the estrogen-like activity derived from unknown substances occupy more than 75% of the estrogen-like activity in the influent sewage.

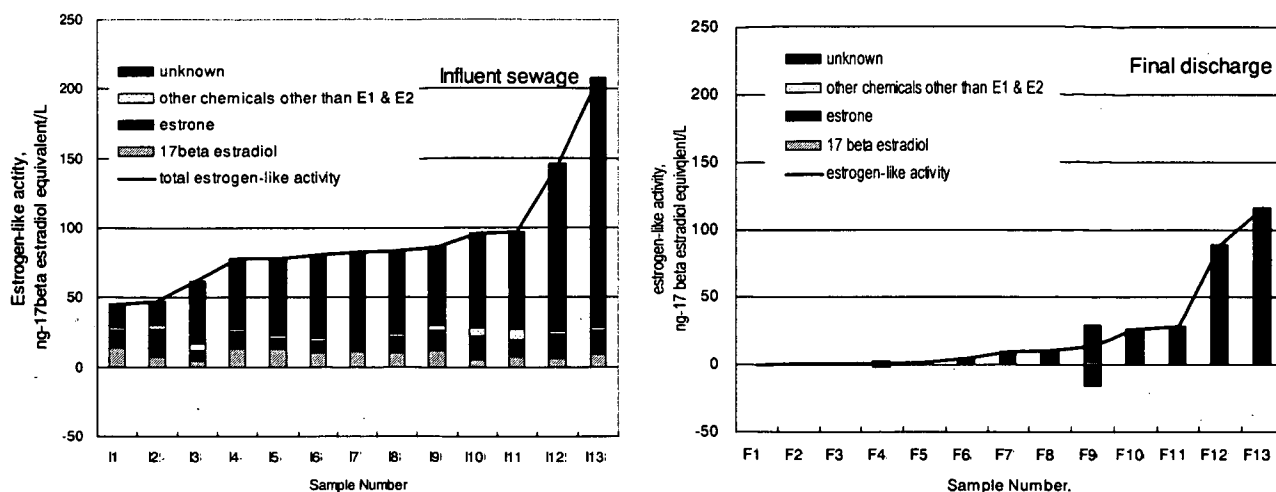

Fig. 11. Estrogen-like activities of influent sewage and final discharge of STPs, calculated based on estrogen data collected using LC/MS/MS (from third year study)

5.2 Gap of 17 β -estradiol (E2) concentration between ELISA method and LC/MS/MS

Recent studies revealed that the concentrations of 17 β -estradiol in sewage and treated sewage analyzed using LC/MS/MS is less than 10% of those analyzed with the ELISA method. ⁽²⁰⁾⁽²¹⁾ The final report released by MLIT in cooperation with Public Works Research Institute (PWRI) and the local governments also revealed the large discrepancy between the 17 β -estradiol concentrations analyzed with the ELISA method and with the LC/MS/MS methods. ⁽¹⁶⁾ The 17 β -estradiol ELISA kit used in the nationwide study is reported to rarely cross-react with estrone (Assay Designs, unknown) that is considered to make little contribution to the value measured with the ELISA kit.

Statistically speaking, however, there is a weak relationship between 17 β -estradiol concentration measured with the ELISA kit and the estrone measured with LC-MS/MS ⁽¹⁶⁾. In our study, the 17 β -estradiol measurement by the ELISA kit caused a positive error in the presence of linear alkylbenzene sulphonate (LAS) at 1000 mg/L; thus, the concentrated LAS in an extract from sewage is thought to be one of the factors that interfere with the ELISA measurement. To remove LAS from an extract, the SPE method was modified; that is, eluate methanol was replaced by dichloromethane. In the modified method, LAS was not eluted from C-18 SPE column while 17 β -estradiol was eluted thoroughly with dichloromethane. When comparing the 17 β -estradiol (E2) concentrations measured with LC/MS/MS and the ELISA method, the concentrations of E2 by ELISA with dichloromethane (as eluate) gave less deviation from those with LC/MS/MS than the concentrations of E2 by ELISA with methanol. The result suggests that the methanol eluate extracts in the previous studies might have contained interfering, hydrophilic substances such as LAS.

Many E2-ELISA kits are commercially available, but their differences are unknown when they are applied to real sewage samples. Therefore, the comparisons were made on following products: Assay Design (E2-AD), Takeda

(E2-TK), Cayman Chemicals (E2-CC), Neogen (E2-NG), and R-Biopharm (E2-RB). For the comparison, 28 samples from various locations of the STP were analyzed with each kit under the same conditions. The extraction column C-18 SPE and eluate dichloromethane were used. Results are presented in Table 5, from which it is seen that all the kits overestimated the concentrations of 17 β -estradiol. Nevertheless, the differences between the LC/MS/MS method and E2-TK ELISA was smallest.

Table 5 Average 17 β -estradiol concentrations in a sewage treatment plant by LC-MS/MS and commercially available ELISA kits ¹⁴⁾

Sample	n	ng/L					
		LC-MS/MS	E2-AD	E2-TK	E2-CC	E2-NG	E2-RB
primary effluent	10	8.4	21.1	12.5	81.4	97.6	202.2
aeration tank	13	1.9	4.4	2.1	9.4	7.8	31.6
secondary effluent	5	1.2	5.3	2.6	15.1	18.8	75.9

5.3 Origin causing estrogenic effects in sewage and treated sewage

What causes estrogen-like activity in sewage or treated sewage? Our previous study suggested the existence of unidentified substances that have a potential to cause estrogen-like activities in sewage, treated sewage, and river water receiving treated sewage. There is strong evidence that estrogen-like activity measured with YES was greater than the estrogen-like activities estimated from concentrations of suspected EDs and their estrogenic potentials. In an effort to identify these substances, we examined the spectrum of estrogen-like activities in sewage and treated sewage using the polarity fractionation method. The fractionation method was carried out as follows:

- 1) One liter of a sample was pre-filtered with a glass fiber filter, GF/B. Then the filtrate was extracted with a C18 solid-phase extraction (SPE) cartridge and was eluted with 10 ml of methanol. The suspended matters on the GF/B were supersonic-extracted twice with 15 ml of methanol. The methanol eluate and the methanol extract were mixed and dried. The residual was solved in 1 ml of hexane (Hex)/dichloromethane (DCM) (50:50, v/v).
- 2) The Hex/DCM solvent was passed through a silica-gel cartridge (SepPack-silica) that had been conditioned with acetone (Ace) and a mixture of Hex: DCM (1:1) in order.
- 3) Nine different polar solvents were prepared by mixing hexane (Hex), dichloro-methane(DCM), acetone(Ace), and methanol (MeOH) as shown in Table 6. The silica-gel cartridge was eluted with each eluate one by one. Then, nine eluate fractions were collected and were named F1 to F9. Each fraction from F1 to F9 was dried and was dissolved again in 0.1 ml of dimethylsulfoxide (DMSO) solution.

Table 6 Eluates used for nine fractionations and distribution of selected COC concentrations

Fraction	Polar Solvent	Chemicals
F1	Hex : DCM=1:1	
F2	Hex : DCM=1:2	
F3	DCM	NP
F4	DCM : Ace = 2:1	NP1EO, E1, E2, E3*, NPnEO(n=2-4), BPA*
F5	DCM : Ace = 1:2	
F6	Acetone	NPnEO(n=5)
F7	Ace : MeOH = 2:1	NP1EC
F8	Ace : MeOH = 1:2	NP2EC, NP3EC
F9	MeOH	

Reference * : measured by recombinant yeast assay, and other chemicals measured by chemical analysis
□ : fractionated the only fraction
△, ▽ : fractionated the some fractions
| : a little detected.

Table 6 indicates which fractionation includes selected COC, suspected EDs and related substances, in the water environment. After influent sewage and effluent sewage were fractionated with the above method, the estrogen-like activity of each fraction was measured using YES. The results based on influent sewage and secondary effluent of 22 STPs (shown in Fig. 12) indicate that the estrogen-like activity is widely distributed from F1 fraction (low polarity) to F9 fraction (high polarity) ranges, for the influent sewage. This finding suggests the existence of unknown substances other than estrone, 17β -estradiol, and nonylphenol in the influent sewage. However, the estrogen-like activity in both F2 and F4 fractions were identified in all the influent sewage samples. Particularly, F4 fraction in both the influent sewage and secondary effluent occupied the largest portion among nine fractions in general, and F2 fraction has the second largest fraction. The estrogen-like activity in other fractions varies with the STPs. In F2 fraction, nonylphenol contributed largest portion to the total estrogenicity for both the influent sewage and secondary effluent. In F4 fraction, estrone and 17β -estradiol are estimated to contribute on average 35% and 6%, respectively, to the total estrogenicity of the influent sewage, while they occupy, respectively, 72% and 4% of the total estrogenicity of the secondary effluent. The result implies that there exist more estrogen-like substances in addition to estrone and 17β -estradiol.

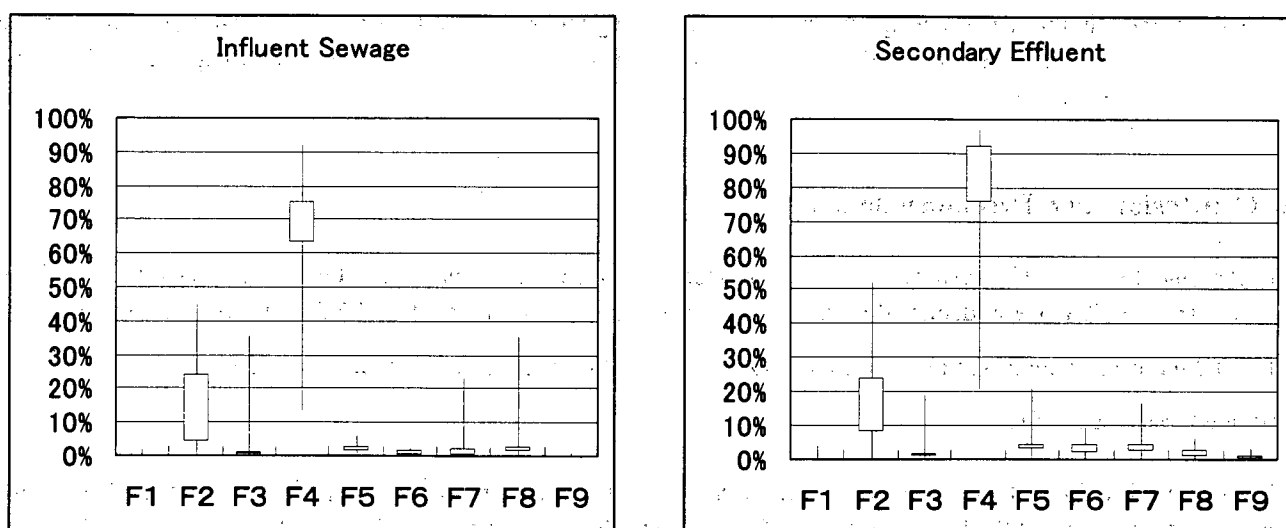

Figure 12 Spectrum of estrogenicities in nine fractions in influent sewage and secondary effluent in 22 sewage treatment plants (range and the 25th and 75th percentiles)

5.4 Carp breeding test – male carp exposed to secondary effluent of a sewage treatment plant

As discussed above, we found that estrogen-like activity exists in sewage discharge although the activity tends to decrease to a large extent in STPs. However, it is not clear if residual estrogen-like activity of STP effluent causes feminization of fish living in their receiving rivers in Japan. UK researchers reported that 1 to 10 ng/L of 17β -estradiol, 25 to 50 ng/L of estrone, and 20 ug/L of nonylphenol cause induction of vitellogenin in male rainbow trout⁽⁴⁾. Japanese researchers also reported that 8 ng/L of 17β -estradiol induces vitellogenin⁽¹⁷⁾ and 5 ng/L of 17β -estradiol produced vitellogenin-like protein in male Medaka⁽¹⁸⁾. Based on such recent studies, remaining estrogens or estrogen-like substances in final discharge from STPs might induce vitellogenin in male fish in the receiving water. The field survey by the MLIT reported that a quarter of wild male carp caught in ten rivers have some vitellogenin in their blood, but the cause of vitellogenin in male carp is unclear⁽¹⁹⁾.

In our carp breeding experiments, male carp were exposed to secondary effluent of a STP. The first experiment was conducted in the early spring of Year 2000. Four male carp out of five increased their serum vitellogenin concentrations that were not observed prior to their exposure to the effluent. The vitellogenin concentration in carp began rising soon after their exposure, and reached to stable levels in four weeks. Eight weeks later, the secondary effluent was changed to dechlorinated tap water. In three weeks, their serum vitellogenin concentrations decreased to the same levels as those in the start of the experiment. An average estrogen-like activity of the effluent measured with YES was $4.9 \text{ ng} \pm 0.8 \text{ ng E2 equivalent /L}$. In the control test using dechlorinated tap water, no serum vitellogenin was confirmed in any male carp. Therefore, the synthesis of vitellogenin in male carp might be reversible depending on the levels of estrogen-like substances, particularly with the estrogen-like activities of the STP effluent we tested.

Two more experimental runs were carried out at the same STP in the summer of Year 2000 and from February to April in 2001. However, any significant increase in the serum vitellogenin concentration could not be observed in the male carp that were exposed to the effluent. Averages of the estrogen-like activities in the effluents measured by YES were $3.7 \text{ ng} \pm 0.4 \text{ ng E2-equivalent/L}$ in the summer experiment, and $7.0 \text{ ng} \pm 1.4 \text{ ng E2-equivalent/L}$ in the winter-spring experiment. Considering the minimal differences of the estrogen-like activities in the effluent in all the experiments, the timing of exposure might be an important factor to explain the inconsistent phenomenon we observed.

6. Conclusions and Recommendations

- (1) Among the 34 COC (suspected EDs and related substances) examined, 18 COC were detected in the influent sewage and 13 COC were identified in the final discharge of at least one of the 47 STPs studied. In these STPs, most of COC were effectively removed from sewage except for 17β -estradiol, estrone, and benzophenone, which were removed less effectively.
- (2) Greater reductions of COC were observed in the secondary treatment than in the primary treatment. The degree of reduction varies with COC. In some of the STPs, the higher levels of certain COC were observed in the influent of the primary treatment than in the influent sewage.
- (3) We observed that, in many instances, levels of the most of COC were smaller in the excess sludge than in the primary sludge. The COC concentrations in the incinerated ash were below their QLS (due to combustion). The elevated levels of nonylphenol and bisphenol A were observed in the digested sludge.
- (4) The advanced treatment processes, particularly combination of ozonation, activated carbon adsorption and/or RO membrane process, reduced the COC concentrations effectively. The processes including sand filtration, ozonation, RO membrane, and activated carbon absorption, removed 17β -estradiol (measured with the ELISA method) and benzophenone effectively. The both compounds were poorly removed in the biological treatment.
- (5) Because the ELISA method tends to overestimate the concentration of 17β -estradiol in the influent sewage and in the final discharge, estrone may exist more than 17β -estradiol in final discharge. The usage of dichloromethane (DCM) as eluate in the SPE elution step can decrease the magnitude of overestimation of 17β -estradiol in sewage.

samples. Based on the comparisons between the methods using the commercially available ELISA kits against the LC/MS/MS method, the E2 concentrations measure by E2 ELISA kit (Takeda) exhibited the smallest differences from those measured by LC/MS/MS.

(6) The estrogenicity of influent sewage was reduced to a large extent in the activated sludge process. In the study with the 13 STPs selected, we found that, in the influent sewage, 17β -estradiol and estrone account for most of the theoretical estrogenicity estimated from the estrogenic potentials of COC and their concentrations. The comparisons between the estrogen-like activity and the theoretical estrogenicity suggest that 17β -estradiol and estrone occupy approximately one quarter of the observed estrogenicity, and that significant amounts of unidentified estrogenic substances exist in influent sewage and final discharge, in addition to the substances monitored in the nation-wide study.

(7) The fractionation technique was applied in order to investigate the causes of estrogen-like activity in sewage and secondary effluent of the 22 STPs. We found that two major fractions (i.e., F2 and F4) contribute to the total estrogenicity of the influent sewage and of the secondary effluent. The fraction F4 coincided with estrone and 17β -estradiol, and occupied the largest portion of the activity, while the fraction F2 coincided with nonylphenol. These findings imply that nonylphenol, estrone, and 17β -estradiol are the major substances that cause the estrogen-like activity. Because some of other fractions also exhibited estrogen-like activity, other estrogen-like substances may exist in the fraction F4.

(8) We conducted experiments in which male carp were exposed to the secondary effluent of the STP. In the first run, the level of serum vitellogenin was increased in 80% of the male carp in four weeks, and the vitellogenin level decreased to the same levels as the beginning of the exposure. Although two additional experiments were conducted, no increase in serum vitellogenin in male carp was observed. Further investigation is necessary to determine if estrogen-like substances in treated sewage cause fish to be feminized.

(9) In the studies of estrogen-like activity in the STP effluent, we concluded that estrogen, nonylphenols, and their derivatives remain dominantly in the final discharge. These compounds are likely transformed to other compounds and are also formed from their precursors. For more comprehensive evaluation of endocrine disrupting chemicals (especially, their fate and effects) in the STP streams and their receiving waters, a more accurate method need to be developed.

Acknowledgments

This nationwide survey with respect to the rivers and sewerages was conducted under the Committee to Study Countermeasures Against Endocrine Disruptors (Chairman: Professor Tomonori Matsuo, Tokyo University), Japan Institute of Wastewater Engineering Technology. The authors appreciate the central and local governments of Japan for the provision of the useful information.

References

- 1 UKEA (1997): *The Identification and Assessment of Oestrogenic Substances in Sewage Treatment Works Effluents*, Environment Agency, UK.
- 2 Jobling, S., Nolan, M., Tyler, C.R., Brighty, G., and Sumpter, J.P. (1998): Widespread sexual disruption in wild fish. *Environ. Sci. Technol.* 32(17): 2498-2506.
- 3 Folmer, L.C., Denslow, N.D., Rao, V., Chow, M., Crain, D.A., Enblom, J., Marcino, J., and Guillette Jr., L.J. (1996): Vitellogenin induction and reduced serum testosterone concentration in fetal male carp (*Cyprinus carpio*) captured near a major metropolitan sewage treatment plant, *Environ. Health Perspect.* 104(10): 1096-1101.
- 4 Routledge, E. J., Sheahan, D., Desbrow, C., Brighty, G.C., Waldock, M., and Sumpter, J.P. (1998): Identification of estrogenic chemicals in STW effluent. 2. In vivo responses in trout and roach. *Environ. Sci. Technol.* 32(11):

1559-1565.

- 5 Munkittrick, K.R., Van Der Mraak, G.J., McMaster, M.E., and Portt, C.B. (1992): Response of hepatic MFO activity and plasma sex steroids to secondary treatment of bleached kraft pulp mill effluent and mill shutdown. *Environ. Toxicol. Chem.* **11**: 1427-1439.
- 6 Goodbred, L.S., Gilliom, R. J., Gross, T.M., Denslow, N.P., Bryant, W.L., and Schoeb, T.R. (1996): Reconnaissance of 17 β -estradiol, 11-ketotestosterone, vitellogenin, and gonad histopathology in common carp of United States Streams: Potential for contaminant-induced endocrine disruption. *USGS - Pesticide National Synthesis Project Pesticides Report*. National Water Quality Assessment, Pesticide National Synthesis Project. USGS Open-File Report 96-627.
- 7 Tanaka, H., Yamamoto, M., Kato, H., Komori, K., Takahashi, A., Yakou, Y., Higashitani, T. (1999): Nationwide surveys on endocrine disruptors in rivers and sewerages in Japan. *Proceedings of the 1st US-Japan Government Conference on Drinking Water Quality Management and Wastewater Control*.
- 8 JEA (1998): *SPEED '98 / JEA-Strategic Programs on Environmental Endocrine Disruptors '98*, Japan Environment Agency, Tokyo, Japan.
- 9 Routledge, E.J. and Sumpter, J.P. (1996): Estrogenic activity of surfactants and some of their degradation products assessed using a recombinant yeast screen, *Environ. Toxicol. Chem.* **15**(3): 241-248.
- 10 Desbrow, C., Routledge, E.J., Brighty, G.C., Sumpter, J.P., and Waldock, M. (1998): Identification of estrogenic chemicals in STW effluent. 1. Chemical fractionation and in vitro biological screening. *Environ. Sci. Technol.* **32**(11): 1549-1558.
- 11 Takigami, H., Matsuda, T., and Matsui, S. (1998): Detection of estrogen-like activity in sewage treatment process waters. *Environ. Sanit. Eng. Res.* **12**(3): 214-219, Kyoto University, Kyoto, Japan.
- 12 Yakou, Y., Takahashi, A., Higashitani, T., Tanaka, H. (1999): Measurement of environmental estrogen-like activity in wastewater using recombinant yeast, *Environ. Engr. Res.* Japan Society of Civil Engineering. **36**:199-208 (in Japanese).
- 13 Tanaka, H., Yakou, Y., Takahashi, A., Higashitani, T., and Komori, K. (2001): Comparison between estrogenicities estimated from DNA recombinant yeast assay and from chemical analyses of endocrine disruptors during sewage treatment. *Water Sci. Tech.* **43**(2):125-132.
- 14 Goda, Y., Hirobe, M., Kobayashi, A., Fujimoto, S., Ike, M., Fujita, M., Okayasu, Y., Komori, K., and Tanaka, H. (2001): Development of the ELISA for detection of estrogenic hormones in environment. IWA 2nd World Water Congress, Berlin, Germany, Poster P0013 (CD-ROM).
- 15 Brunner, P.H., Capri, S., Macromini, A., and Giger, W. (1998): Occurrence and behaviour of linear alkylbenzenesulphonates, nonylphenol, nonylphenol mono- and nonylphenil diethoxylates in sewage and sewage sludge treatment. *Wat. Res.* **22**(12): 1465-1472.
- 16 MLIT (2001): *Final Report on Countermeasures for Endocrine Disruptors in Sewerage Systems*, Ministry of Land, Infrastructure and Transport, Tokyo, Japan (in Japanese).
- 17 Ishibashi, H., Natarazako, and K.Arizonzo.(2002), Monitoring using Japanese Medaka. (*Oryzias latipes*), *Envio*, **2**, pp39-44.
- 18 Kashiwada S., Ohnishi Y., Ishikawa H., Miyamoto N. and Magara Y.(2001)Comprehensive Risk Assessment of Estradiol-17 β , p-Nonylphenol, and Bis-Phenol-A in River Water in Japan, *Environment Sciences*, Vol.8, No.1, pp.89-102.
- 19 MOC (2000). *Interim Report on FY 1999 Fact-finding Study on Endocrine Disruptors in Water Environment*, Ministry of Construction (in Japanese).
- 20 MLIT (2001). *Interim Report on FY 1999 Fact-finding Study on Endocrine Disruptors in Water Environment*, Ministry of Land, Infrastructure and Transport (in Japanese).
- 21 Takahashi A. et al. (2000) Determination of Female Hormone in Sewage Samples by LC/MS/MS and ELISA, *Proceedings of 3rd Japan Society on Water Environment (JSWE) Symposium*, p.175-176, JSWE (in Japanese).
- 22 Komori, K. et al. (2001). Analytical Method for Estrogens in Wastewater by LC/MS/MS, *Proceedings of 9th International Conference on the Conservation and Management of Lakes held on November 11-16, 2001 in Ohtsu, Shiga, Japan* (in Japanese).

**19. Evaluation of Drinking Water Treatment Technologies
for Removal of Endocrine Disrupting Compounds**

Presenter

Ms. Kathleen Schenck, USEPA

Evaluation of Drinking Water Treatment Technologies for Removal of Endocrine Disrupting Compounds

Kathleen Schenck and Thomas Speth, U.S. EPA, NRMRL
 Laura Rosenblum, Steve Wendelken, Barry Peplch,
 and Radha Krishnan, Shaw, Inc.
 Thomas Wiese, Xavier University of Louisiana

Endocrine disrupting compounds (EDCs) are exogenous agents that interfere with the synthesis, secretion, transport, binding, action, or elimination of natural hormones in the body that are responsible for the maintenance of homeostasis, reproduction, development, and/or behavior.

Many of the chemicals identified as potential endocrine disrupting compounds (EDCs) may be present in surface or ground waters used as drinking water sources due to their introduction from:

Domestic and industrial sewage treatment systems.

Wet-weather runoff.

Occurrence of EDCs in U.S. streams

Compound	Number of samples	Reporting limit $\mu\text{g/L}$	Freq. of detection %	Maximum conc. $\mu\text{g/L}$	Median detectable conc. $\mu\text{g/L}$
estradiol	70	0.005	10.0	0.093	0.009
ethynyl estradiol	70	0.005	5.7	0.273	0.094
testosterone	70	0.005	2.8	0.214	0.116
nonylphenol	85	0.50	50.6	40*	0.8*

*: concentration estimated - reference standard from technical mixture
 From: Environ. Sci. Technol. 36,1202 - 1211, 2002,
 Environ. Sci. Technol. 36,407 - 4008, 2002

Basic strategies to decrease the potential risk of adverse health effects associated with the presence of EDCs in drinking water:

Protect drinking water sources from contamination by EDCs.

Remove EDCs, that may be present in source waters, during drinking water treatment.

Compounds to be evaluated

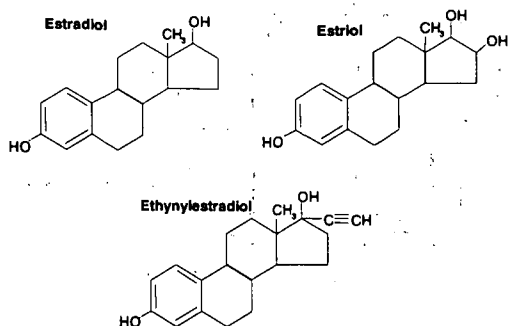

Compounds to be evaluated

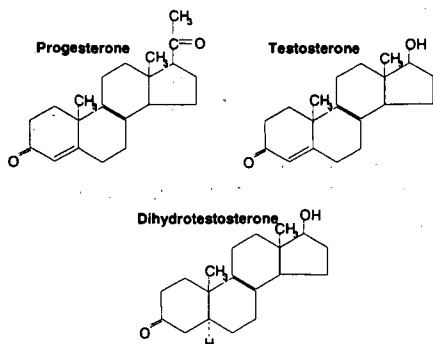

Additional compounds to be evaluated in the future

- 4-nonylphenol (NP)
- 4-nonylphenol mono-ethoxylate (NP1EO)
- 4-nonylphenol diethoxylate (NP2EO)
- 4-octylphenol mono-ethoxylate (OP1EO)
- 4-octylphenol diethoxylate (OP2EO)

Technical approach

Develop analytical methods to identify and quantify the target compounds. The approach includes concentration by solid-phase extraction, followed by LC/MS.

Analytical method for steroid compounds

Solid phase extraction:

Baker C18 XF speed disks eluted with methanol

Quantitation:

Waters ZQ LC/MS, electrospray
Xterra C18 column
Single step gradient, 50 – 65% methanol in ammonium hydroxide in water
Single ion mode

Single ion chromatograms of reagent water fortified at 1ng/L

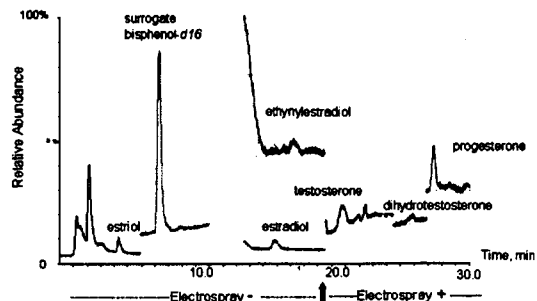

Technical approach (cont.)

Evaluate the use of a reporter gene assay, the MVLN assay, to detect the presence/ removal of estrogenic activity. This assay uses a human breast cell line (MCF-7) which has been stably transfected with the firefly luciferase gene.

Technical approach (cont.)

Conduct bench-scale evaluations of various drinking water treatment technologies, including granular activated carbon, nanofiltration, softening and conventional treatment.

Pilot-scale evaluations may be conducted on the treatment technologies that appear promising at bench-scale.

Granular activated carbon (GAC) Isotherm studies

Organic-free water buffered to pH 7 with phosphate buffer (0.005 M)

Target compound added to buffer and mixed for approximately 4 days

Solution added to isotherm bottles containing various amounts of GAC (100 X 200 mesh)

After carbon reaches equilibrium, solution is pumped out through a 0.22 μm filter

Initial and final concentration data used to determine adsorption capacity of GAC

Stability of testosterone over time

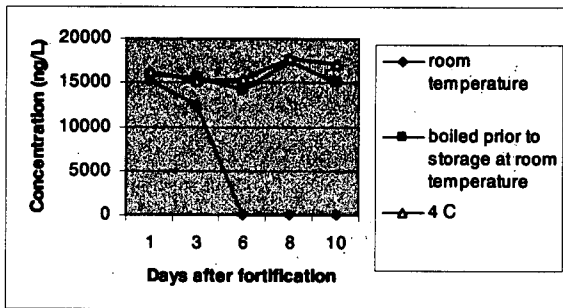

Stability of dihydrotestosterone over time

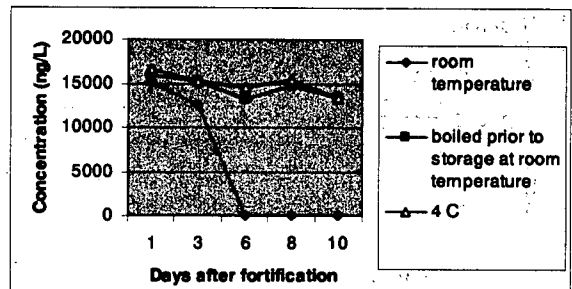

Stability of progesterone over time

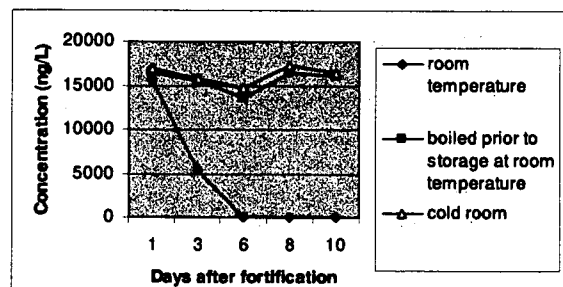

Stability of estradiol over time

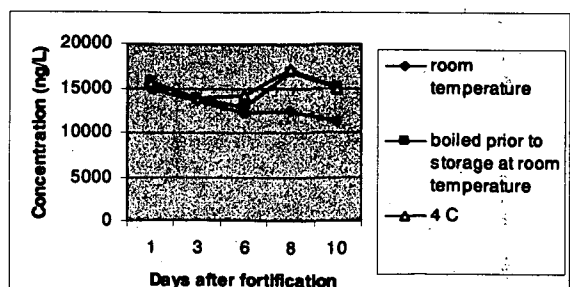

Stability of estriol over time

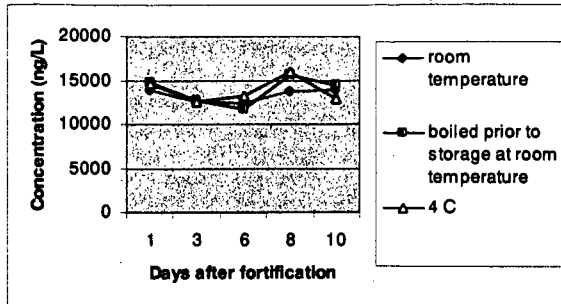

Stability of ethynylestradiol over time

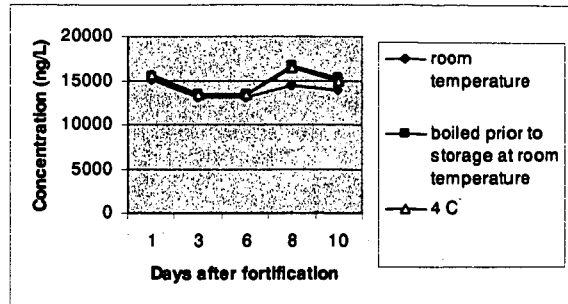

Stability of steroids in filtered buffer

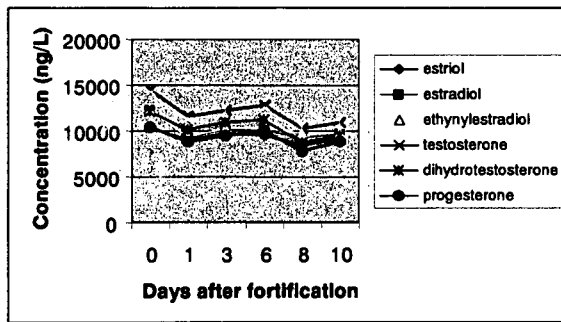

Activated Carbon Treatment

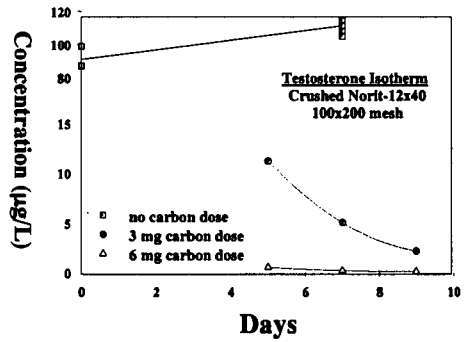

Activated Carbon Treatment

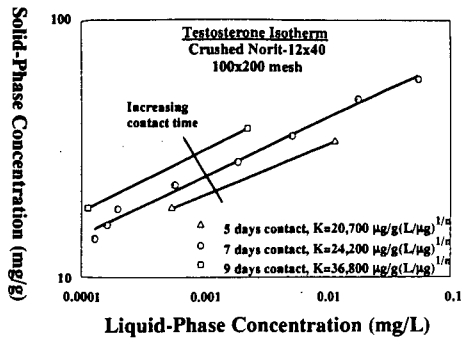

This study will provide information on:

currently available drinking water treatment technologies that can remove EDCs, specifically the steroid hormones and the alkylphenolic compounds.

approaches to optimize these treatment technologies for EDC removal.

20. Security Measures Against Terrorism and Seismic
Reinforcement Measures of Existing Buried
Large-Diameter Pipeline in Tokyo

Presenter

Mr. Yoshito Makita, Bureau of Waterworks

Tokyo Metropolitan Government

Security Measures Against Terrorism and Seismic Reinforcement Measures of Existing Buried Large-Diameter Pipeline in Tokyo

Yoshito Makita

Bureau of Waterworks Tokyo Metropolitan Government

1. Security Measures Against Terrorism

Water works facilities play an important role such as supplying tap water that is indispensable for lives of residents and for almost every phase of industrial and economic activities in Tokyo. Therefore, when water supply is suspended by terrorism, significant influences would be caused for the society.

Each main purification plant in Tokyo cover 2 or 3 million customers. However sedimentation basins and filtration basins are open-air, therefore security measures for the purification plants are very important.

The occurrence of the 1995 sarin gas attack on the subway system and the September Eleventh Terrorist Attacks in USA last year enhanced security of Tokyo Metropolitan Waterworks (TMW) such as measures to prevent trespass to the purification plants etc.

It is expected as terrorist attacks that waterworks facilities are destroyed and the toxic substances are thrown into filtration basins etc. When a waterworks facility such as a purification plant and a water supplying station is destroyed, supply lines will be changed immediately and other facilities will support it. Prevention measures against trespass and installation of water quality detectors have been implemented against the attacks with toxic substances.

This paper reports sensors into purification plants, detectors with fish for toxic substances in raw water or treated water, and covering the filtration basins. The sensors for detecting trespass were recently installed in the purification plants of TMW. Further more an experiment on automatic-type detectors with fishes is proceeding for installing in next fiscal year. Covering the filtration basins are on planning. These are the works in response to the recent terrorist attacks.

(1) Sensor for Detecting Trespass

Effectiveness of the measure with observation by human against the trespass is limited, because a purification plant occupies large area. Therefore sensors for detecting trespass were installed on the top of outskirts fences and the entrances of the purification plants of TMW, in addition to surveillance TV. The sensors were connected to the security company through online system, to cope with trespass immediately. (Figure-1)

The preventive sensors for detecting trespass have been installed at the nine out of the ten purification plants of TMW. It was planned to install sensors in the rest of purification plants in this fiscal year.

There are two types of sensor, one is a infrared rays-type and the other is a trap-type.

Figure-1 Sensor System against Trespass

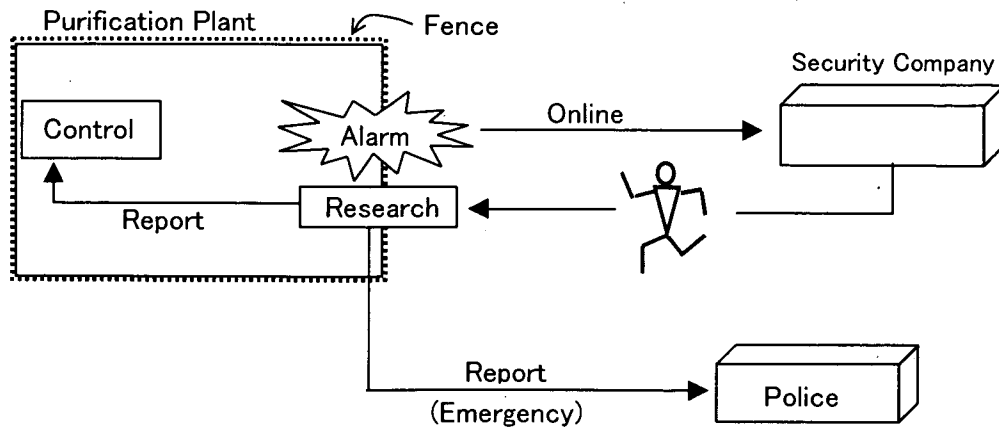

① Infrared Rays-type Sensor (Figure- 2)

A infrared rays-type sensor catches the trespass when the rays are cut. The sensors were installed on the top of outskirts fences to detect the trespass.

The sensor sends two or more rays and give a warning in the case of cutting plural rays at the same time to prevent miss judgement from a little living thing passing. The sensor can cover the distance of about 200 m. Since infrared rays are not obstacle to passing, this style can be installed at entrances.

Figure-2 Infrared Rays -type Sensor

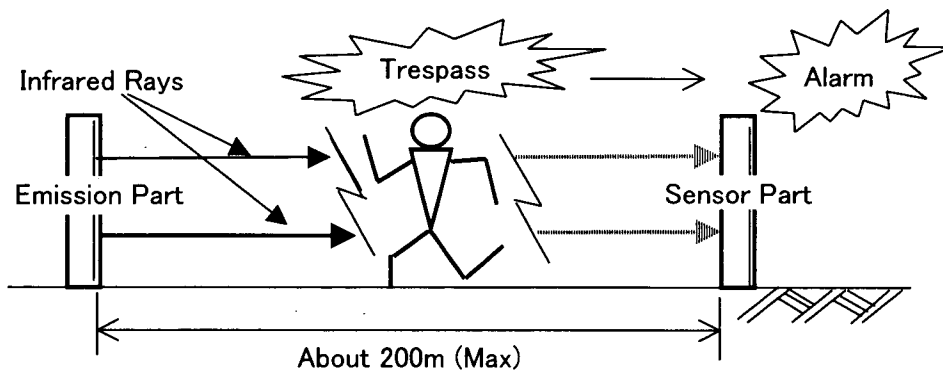

※ Sensor sounds alarm in a case of cutting two rays.

② Trap-type Sensor (Figure-3)

When someone touches the warning wire installed on the top of the outskirts fence to trespass, the sensor catches the stress caused by the contact and gives a warning. By stringing the warning wire in the net fence, the sensor also can respond to cutting the net of the fence.

Figure-3 Trap-type Sensor

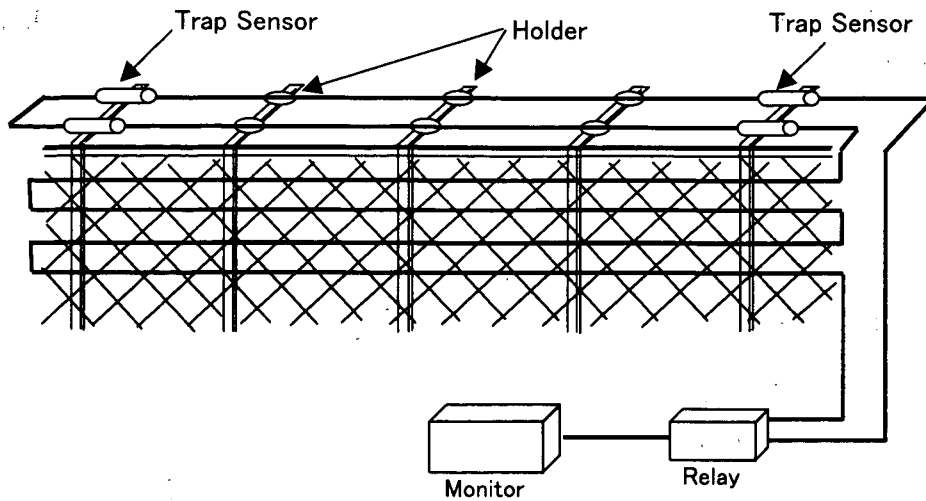

③ Added Measures

It enhances the effect of preventing the trespass by giving threat and discovering quickly to install the surveillance TV and the alarm.

(2) Detector for Toxic Substances with Fish

This detector catches the change of the water quality by analyses of fish behavior. Fish is sensitive to the water quality change, therefore this sensor can catch early unusual water qualities and various toxic substances quickly.

There are two types of detector. The one is observation by human and the other is by automatic observation. Automatic observation is consisted of the electric potential type and the picture analysis type.

① Picture Analysis Detector (Figure-4)

The picture analysis detector is composed of a surveillance TV and a picture analysis instrument. It observes fish behavior and catches the change of the behavior and catches the change of the behavior in response to harmful substances.

Figure-4 Picture Analysis Detector

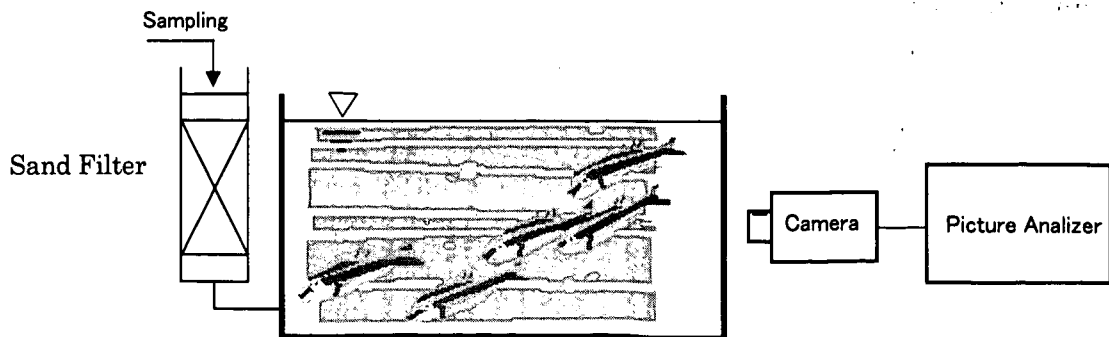

② Electric Potential Detector (Figure-5)

The electric potential detector catches unusualness of water quality by analyzing electric potential change caused by unusual behavior of the fish in response to harmful substances mixed into the water in the tank.

Figure-5 Electric Potential Detector

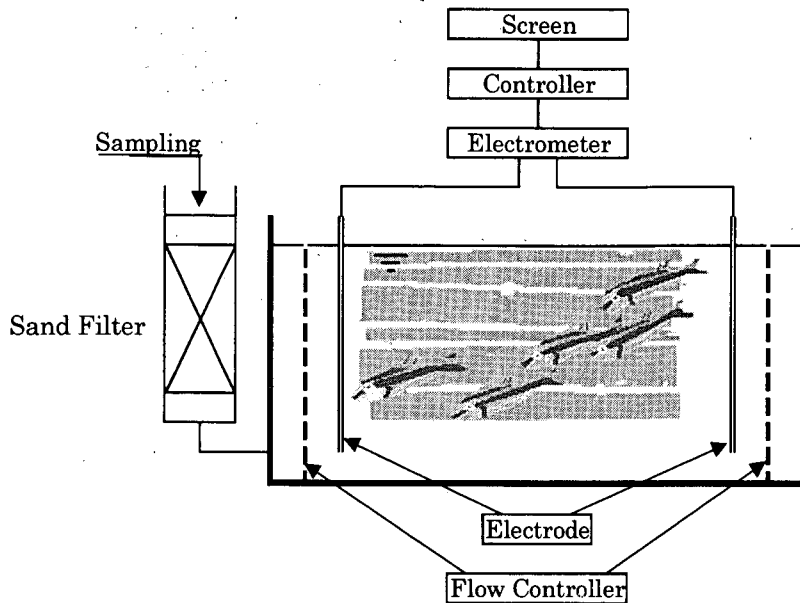

(3) Covering Filtration Basin

The filtration basins of TMW are not safe from the attacks with toxic substances for the open-air structure. Covering filtration basins is effective for the security and for the restraint on algae occurrence. Furthermore it will improve the environment around the purification plant, decreasing the noise of washing filter sand. It will also be possible to use the area for the sunlight generation.

There are two covering procedures, housing-type and movable arch cover-type.

TMW is planning to carry out covering filtration basins as soon as possible, because filtration is the final treatment process. It will be decided being based on the necessity whether sedimentation basins to be covered after completion of covering filtration basins, since there is enough time to take a means such as stopping the works of plants, in an emergency.

2. Seismic Reinforcement Measures of Existing Buried Large-Diameter Pipeline

The Central Disaster Prevention Conference has issued a warning that there is an urgent threat that a large earthquake may occur just below Tokyo. When a large earthquake occurrence causes suspension of water supply for a long time, citizens' lives will suffer immeasurable damage. Therefore, it is a major issue for Tokyo Waterworks to improve facility's weak points against the earthquake expected and to restore the waterworks function speedily after the earthquake occurrence.

Tokyo Metropolitan Government is proceeding with upgrading important facilities to mitigate the damages from the potential earthquake one after another. This paper reports a seismic diagnosis and a reinforcement measure of an existing buried large-diameter pipeline ($\phi 2200\text{mm}$) according to the result of the diagnosis.

(1) Outline of Objective Pipe

The objective of the seismic investigation is a Raw Water Connection Pipeline (RWCP) that connects Asaka Purification Plant with Higashimurayama Purification Plant. Asaka Purification Plant intakes raw water from Tone River and Higashimurayama Purification Plant intakes from Tama River, respectively. (Figure-1) The system composed of RWCP, the two purification plants and two rivers makes it possible to intake according to flow volumes of two rivers to promote water storage in reservoirs efficiently and to make up a lack of raw water of another purification plant in a drought or a raw water accident.

The diameter and the length of RWCP are 2200 mm and 16.8 km respectively. RWCP is composed of 8.9km length of steel pipeline (SP) and 7.9km length of ductile cast iron pipeline (DCIP). (Table -1)

SP has Telescope-type expansion joints and DCIP has K-type joints. (Figure-2)

Figure-1 Raw Water Connection Pipe

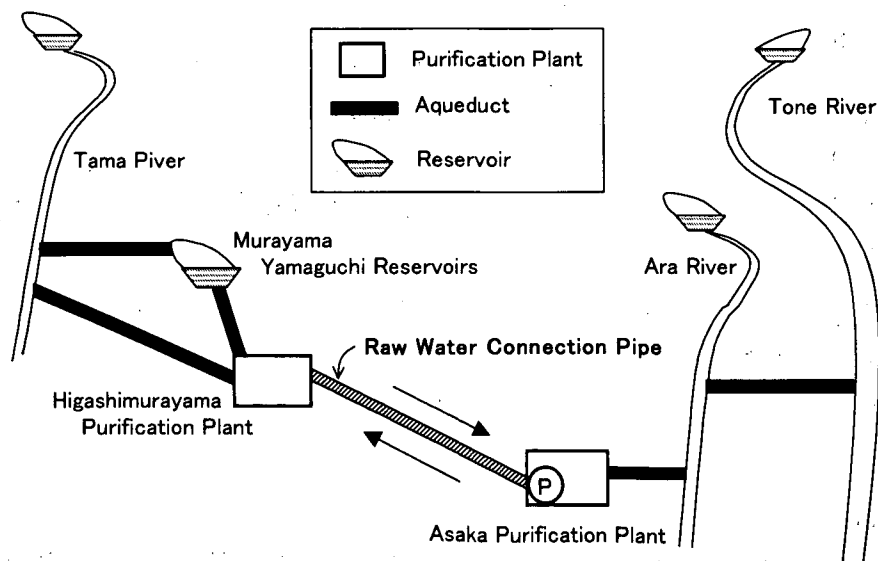

(2) Inner-Surface Investigation

An inner surface investigation of RWCP was carried out while the pipeline was suspended.

① Investigation of Corrosion and Coating

Measurement of corrosion depth with depth-gauge, pipe-body thickness with supersonic wave-type measuring instrument and coating depth with electromagnetic-type measuring

instrument, were implemented at the inner surface of pipe fittings of DCIP without mortar lining parts and at the weld parts of SP, that got rusty.

② Investigation of Mortar-Lining (DCIP)

Mortar-Lining chips were sampled and a solution of phenolphthalein was applied on the chips to measure neutrality depth. Exfoliation and crack on the mortar-lining surface were searched by human eyes.

③ Measurement of Pipeline Level

Level measurements were carried out to inspect subsidence of the pipeline.

④ Investigation of Joints Clearances

Clearances of joints at four points (up and down, right and left) in cross sections of the pipeline were measured. An critical value of the K-type joint was defined as the length between the gasket surface and the bottom of the socket.

Two critical values of the Telescope-type expansion joint were defined as the length between the gasket surface and the bottom of the socket and as zero that represents no clearance. (Figure-2)

(3) Seismic Diagnosis

Stress and strain of the pipe body and the joint clearances in the case of earthquake

Table - 1 Outline of Raw Water Connection Pipe

Diameter	2200 mm
Length	16.8km
Kind of Pipe	DCIP : 7.9km SP : 8.9km
Type of Joint	K-type Joint(DCIP) Telescope-type Expansion Joint (SP)
Year Completed	1964

DCIP : Ductile Cast Iron Pipe

SP : Steel Pipe

Figure-2 Detail of Joint

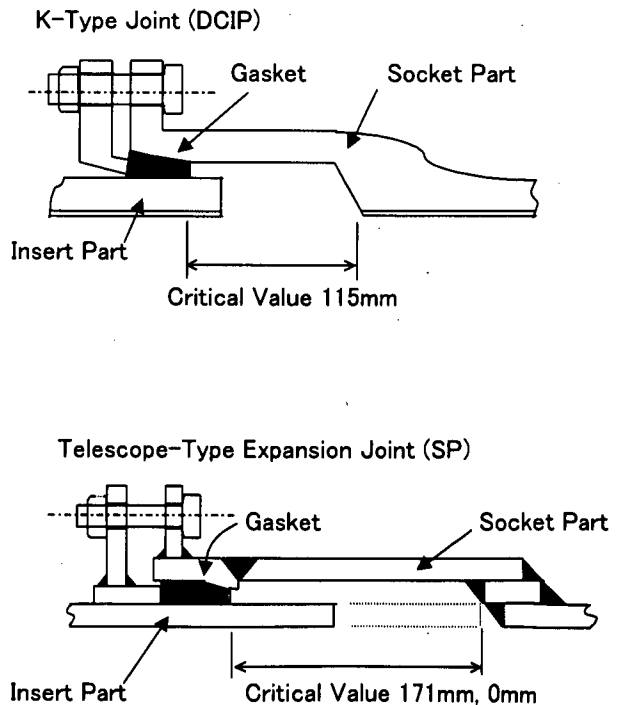

motion of Level 1 and Level 2 were estimated with the response displacement method according to the Seismic Design Code for Water Facilities by JWWA. Level 1 represents an earthquake level to occur once or twice during the facility's life. Level 2 represents a level which occurs with a very low probability but causes considerable damage.

The result of the boring research indicated that the depth of the base layer under the steel pipeline varied significantly. Therefore the steel pipeline was divided into five blocks in the seismic analysis. (Figure-3)

The estimated axial displacements of the joints with the seismic analysis were added to existing clearances of the joints. The composite clearances of the joints were compared with the critical values. The joint displacement caused by bending was also considered in the seismic analysis, because of the large diameter of the RWCP.

The ground was composed of several layers such as buck-fill soil, loam, clay, sandy soil, sand with gravel etc. The layer of sand with gravel was defined as the base layer in the seismic analysis. (Table-2)

Figure - 3 Depth of Base Layer in Each Block

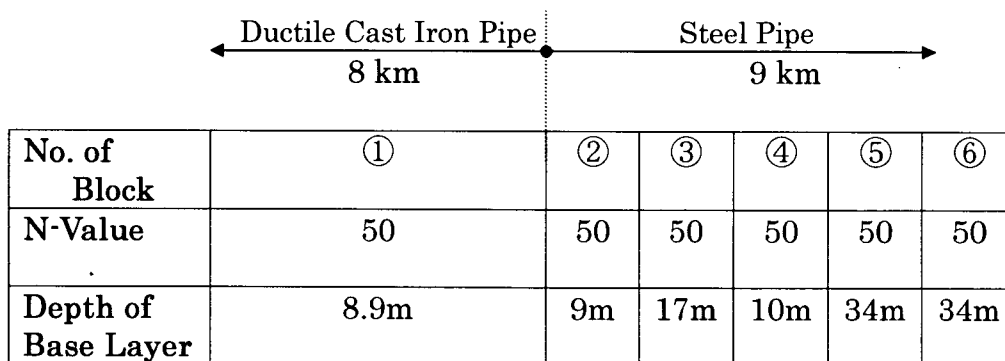

Table - 2 Ground Condition

Kind of Soil	N-Value	Thickness of Layer
Back-Fill Soil	3~5	0.9~3.8m
Loam	2~6	3.0~5.65m
Clay	1~8	1.75~3.55m
Sandy Soil	12	1.10m
Sand with Gravel	18~≥50	4.25~13.25m
Clay	5~18	0.85~3.95m
Sand with Gravel	32~≥50	7.45~14.05m
Sand	17~43	0.50~1.90m
※ Sand with Gravel	≥50	0.52~0.78
Clay	≥50	3.30

※ : Base Layer

(4) Result of Investigation

① Corrosion on the ductile iron and the steel pipe proceeded slightly. The surface

condition of mortar lining and coating was almost well.

② Whole of the pipeline subsided. Some clearances and bending angles which exceeded critical value were found at some existing joints.

③ The result of seismic analysis as follows.

Clearances of three joints of SP and one joint of DCIP exceeded the critical value in the case of Level 1, and clearances of twenty four joints of SP and three joints of DCIP exceeded in the case of Level 2.

(Table-3)

Table - 3 Number of Joints Whose Clearances

Exceeded Critical Value			
	Level 1	Level 2	Number of Joints
DCIP	1	3	1977
SP	3	24	35
Total	4	27	2012

DCIP : Ductile Cast Iron Pipe

SP : Steel Pipe

Stress caused in the DCIP body

and strain caused in the SP body were less than the critical value.

(5) Seismic Reinforcement Measures

Four joints whose clearances caused by Level 1 motion were over the critical value, were reinforced seismically. When alternatives of reinforcement were adopted, it was considered that the suspension term of RWCP should be as short as possible.

① Reinforcement Measure of DCIP

The joint which needed to be reinforced, connected a steel pipeline passing under a rail road with a ductile cast iron pipeline.

The socket part of the joint was the ductile cast iron pipe and the insert part was the steel pipe. The purpose of the reinforcement measure was to make insert pipe length longer by welding a steel pipe to the edge of the existing insert steel pipe.

Before welding, the new steel inner-pipe was divided into three parts in the cross section and eleven parts in the axial section as shown in the Figure-4.

The each piece was carried into the existing DCIP through a manhole and to the objective joint in the pipeline. The pieces were assembled and welded there. A special instrument was used to assemble the pieces before welding.

The space between the existing pipes and the new steel inner-pipe was filled up with air mortar. A rubber gasket was installed between existing pipes and the edge of the new inner pipe to prevent leakage. The inner surface of the new pipe was coated with liquid epoxy resin.

② Reinforcement measure of SP

Telescope-type expansion joints of SP which needed reinforcement measures, were cut off, and steel bands were welded to the outer surface of the existing pipe to change the objective parts into continuous body.

Before welding, the new steel band was divided into three parts in the cross section.

The each piece was carried into the maintenance room through a manhole and welded

to the existing pipe as shown in the Figure-5.

Figure-4 Measure for Reinforcement (K-type Joint)

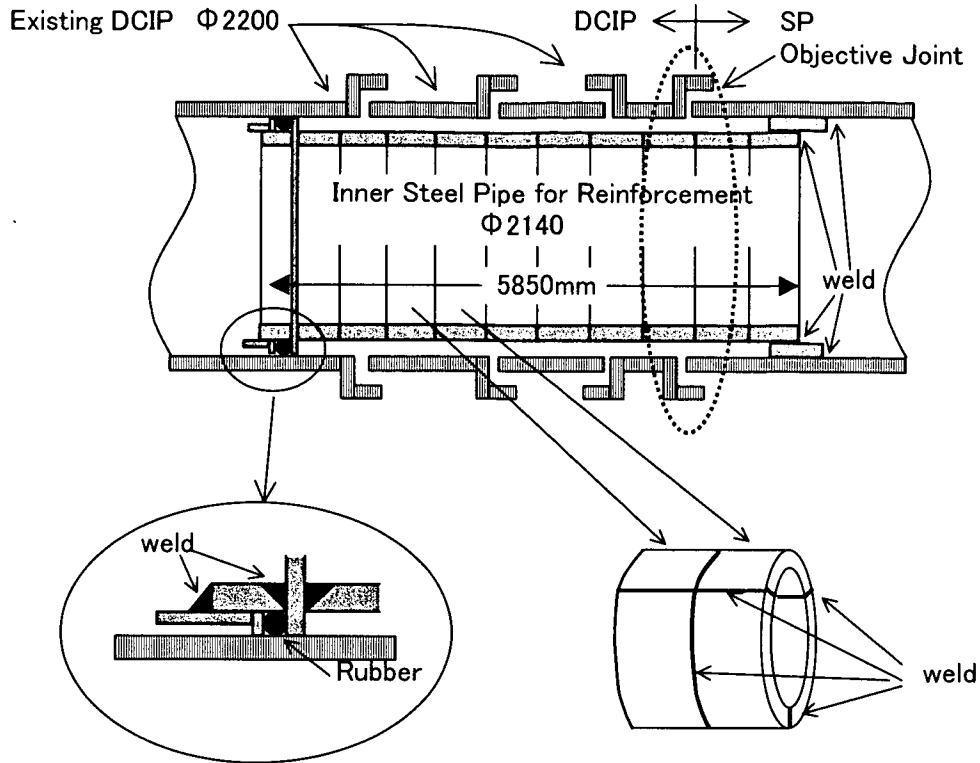
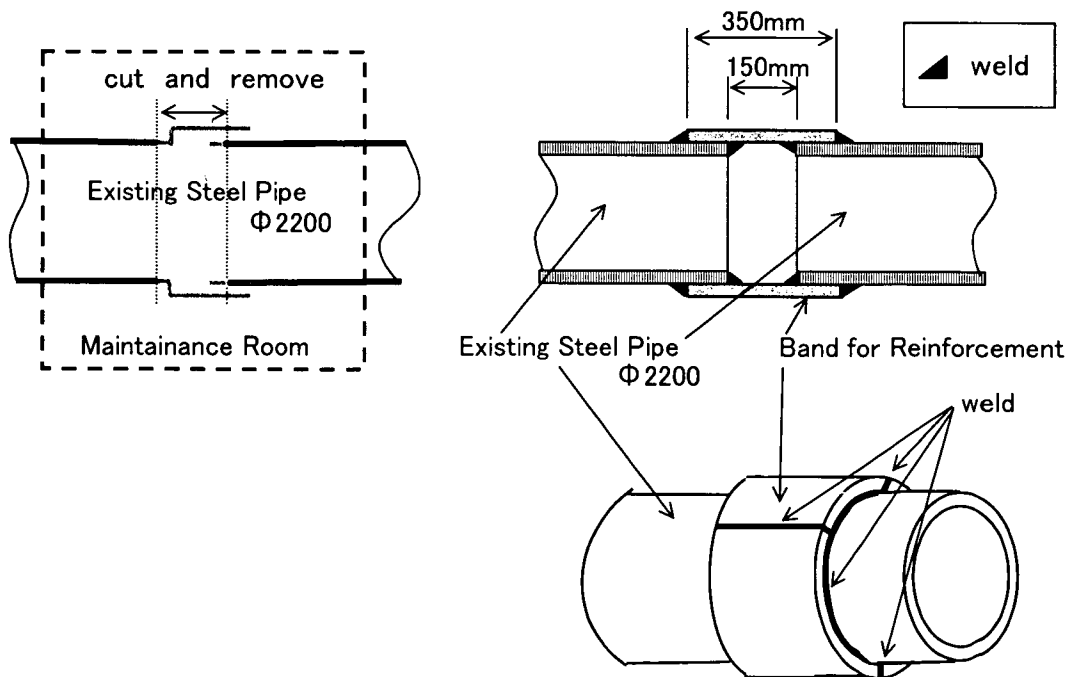

Figure-5 Measure for Reinforcement (Telescope-type Expansion Joint)



(6) Future Issue

① Seismic alternatives for the joins whose clearances caused by Level 2 motion exceeded the critical value, should be considered separately. Because the measures presented in this report needs long term of RWCP's suspension for the many objective joints.

② It should be considered how to reinforcement the large diameter transmission and distribution pipelines which can not be suspended.

**21. STRATEGIES for CRITICAL INFRASTRUCTURE
PROTECTION**

Presenter

Dr. Steve Clark, USEPA

STRATEGIES for CRITICAL INFRASTRUCTURE PROTECTION

Steve Clark
USEPA
Washington, DC

TERRORISM and WATER SUPPLY

- The fear of contamination is likely worse than the reality
- Low probability, but high impact event
- 1991 Gulf War; Presidential Decision Directive --- 63 (May 22, 1998)

GOALS OF PDD -- 63

- Partnership with industry; focus on large metropolitan systems (economic concern)
- Work with other federal agencies (energy, defense, health, FBI, etc.)
- Characterize threat and develop tools
- Implement Information Sharing and Analysis Center (industry based)

SINCE 9-11-01

- EPA'S role expanded
- All systems are now receiving some financial assistance (360 to 55,000)
- EPA and associations provide training, tools, and federal grants/loans
- EPA research capability increased

THREATS to WATER SUPPLIES

- Historic concerns
- Nuclear, biological, chemical contaminants
- Physical damage
- Cyber Attacks (SCADA, supervisory control and data acquisition)

TODAY'S THREATS

- US as sole remaining superpower
- 9-11 had huge economic impact (stock market, airlines, etc)
- Intelligence warning still unlikely
- Enemy extremists with substantial resources

PROVIDING SECURITY

- Vulnerability assessment methodology
- Emergency response guidance
- River flow and pipeline models
- Information Sharing and Analysis Center
- Analytical methods
- Other research (disinfection, stability, treatment,etc)

CONCLUSION

- Increased awareness and need for security since 9-11-01
- Federal Government providing information, tools, R+D, and some money
- First step is to assess vulnerabilities against a reasonable threat
- Solutions must be cost-effective

**22. NEW TRENDS OF WATER TREATING
TECHNOLOGY**

~ On research for development of high-efficiency
purification technology (ACT21) ~

Presenter

Mr.Hideki Hayashi, Water Treatment Technology Division



NEW TRENDS OF WATER TREATING TECHNOLOGY
~ On research for development of high-efficiency
purification technology (ACT21) ~

Hideki Hayashi

ABSTRACT

Research for development of high-efficiency purification technology (ACT21 –Advanced Aqua Clean Technology for 21st Century) is a large-scale R&D program which was implemented, with a subsidy from the Ministry of Health, Labor and Welfare, over a period of 5 years from the fiscal year 1997 to 2001. This project was started with a view to solving many different problems and tasks such as creating new technologies suitable to requirements of new age, while conforming to the policy target of cost reduction, in planning renewal of purification facilities, at this time when the water services in Japan marked a history of over 100 years and got into a period for renewal of facilities, a problem of water quality pollution by trace harmful chemical substances, cryptosporidium, etc., meeting people's needs for safe potable water, etc.

In this report, we will describe an outline of the research achievements of this project implemented over a period of 5 years.

1. Introduction

Japan Water Research Center (JWRC) implemented from the fiscal year 1991 to 1993, a project named MAC21(Membrane Aqua Century 21) that researches were made on application of membrane filtration technology to the field of water services.

Moreover, a project named MAC21 Advanced Treatment was implemented during the period from the fiscal year 1994 to 1996 and at that time, researches were made for expanding the scope of application of membrane filtration technology to advanced water treatment intended not only for removal of turbidity and disinfection but also for removal of insecticides and substances with foul smell.

After those research projects, high-efficiency purification development study was implemented for a period of 5 years from the fiscal year 1997 to 2001.

Hideki Hayashi: Water Treatment Engineering Dept., Japan Water Research Center.
Toranomomon Denki Bldg., Toranomomon 2-8-1, Minato-ku, Tokyo, 105-0001, Japan

The background of the above is as follows:

The water industry in Japan has a history of over 100 years since water supply was started in Yokohama City in 1887, and now the time has come for renewal of facilities, from a problem of deterioration of water facilities. In that case, the purification facilities, etc. are often planned to be supplemented with new functions, in other words, high-efficiency technologies have come to be looked for.

Here, high-efficiency technologies are interpreted as technologies with higher reliability of treatment, enabling reduction of equipment size or requiring a smaller surface area for installation, enabling more energy saving, capable of promoting labor saving in control, enabling simplification and cost reduction, and having higher pollutant removing performances, compared with conventional technologies

A research project was implemented, by globally evaluating such technologies and defining them as high-efficiency technologies.

2. The research system for the project.

This project was implemented by organizing on JWRC's initiative, a joint research system by the government, the academic circle and the private sector, with cooperation from Institute of Public Health, universities, water works and companies who are members of this Center, and other related associations, under the guidance of the Ministry of Health, Labor and Welfare.

This project was promoted by the following committee organization.

In the first place, Coordination Committee and Research Committee provide general guidance on the execution of this project.

Here, Coordination Committee is a committee for discussing matters regarding the project budget and operation, etc., while Research Committee discusses the contents of researches.

Under those Committees are established 7 Study Groups or Study Groups No. 1 to No. 7, for actually working on the 7 research themes as follows.

- Study Group No. 1: "Effective purification of water from lake, marsh and reservoir water sources"
- Study Group No. 2: "Effective purification of water from river and tributary water sources"
- Study Group No. 3: "Application of new membrane filtration technology"
- Study Group No. 4: "Development and practical use of alternative disinfection"

- Study Group No. 5: “Efficient disposal of drainage from water treatment plants”
- Study Group No. 6: Methods for diagnosis and improvement of water treatment facilities”
- Study Group No. 7: “Improvement of measuring and control instruments at treatment plants”

In addition, we established Research Project Committee to take charge of exchange of information among companies, Working Group for studying new coagulant, Literature & Extract Committee, Results Summarizing Committee for summarizing results of studies by the respective Study Groups, and Working Group for preparing technical data.

As modes of implementation of the studies, the studies were conducted in the form of either joint study, individual study or basic study.

A joint study is a study made jointly by all related organizations participating in this project.

An individual study is a study made by the water works or private enterprise belonging to the respective Study Groups No. 1 to No. 7, based on the research policy stipulated by the respective Study Groups.

Experiment Sites

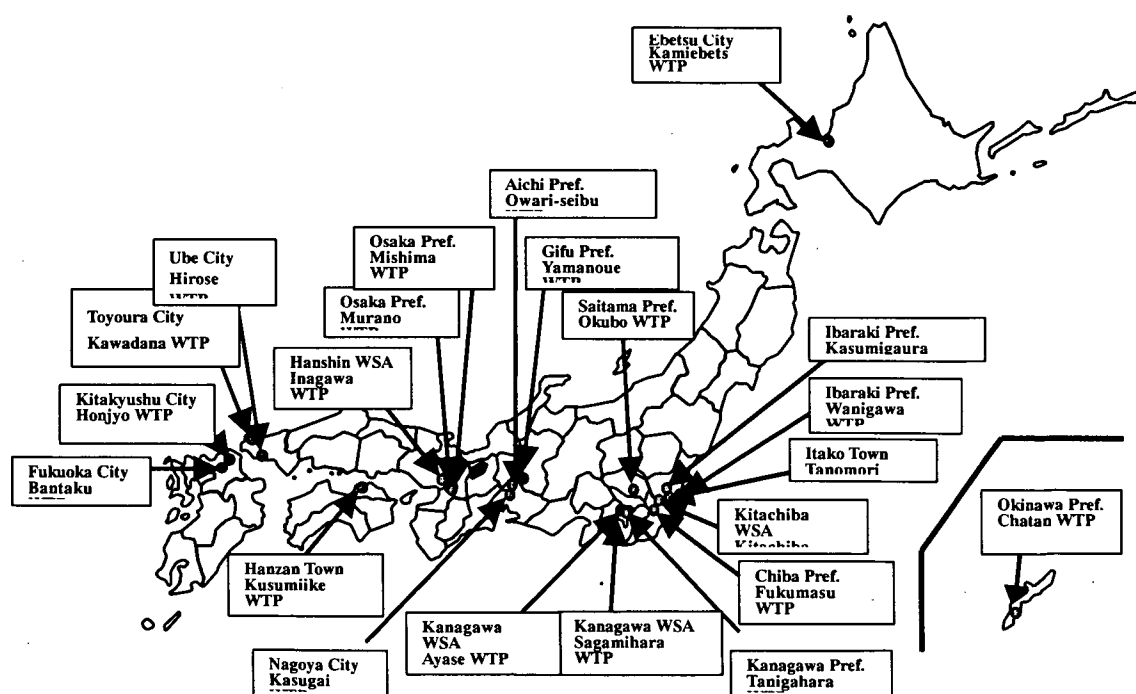

A basic study is a study made by researchers of university, etc. belonging to the respective Study Groups, for the purpose of establishing foundation technology on the research subject to be taken charge by the Group concerned.

As for places of experiments, the experiments were conducted at 22 purification plants all over Japan from Hokkaido in the north to Kyushu and Okinawa in the south. (Refer to the map above)

3. The contents of study of the 7 research themes and achievements.

- 1) "Effective purification of water from lake, marsh and reservoir water sources" made by Study Group No. 1.

For treating raw water from lakes and marshes by conventional coagulation/sedimentation and rapid filtration method, there are a variety of problems to be solved.

The first problem is fluctuations of raw water quality.

In the case of raw water from lakes and marshes, there are increase of algae due to eutrophication in particular, and rise of pH resulting from it, and they cause various problems in the treatment, such as prevention of coagulation, clogging of filter, etc.

Moreover, there is a problem of cryptosporidium these days.

To prevent leakage of cryptosporidium, it is necessary to treat the water until the turbidity becomes extremely low.

The turbidity of treated water is provisionally stipulated as approximately 0.01 NTU, as target value for preventing leakage of cryptosporidium.

It is therefore necessary to establish technologies enabling stable and effective treatment for protection against such problems, so study was made using test plant for the following items.

A. Examination of the type of coagulant

At present, aluminum based coagulants are widely used in Japan. On our side, we studied possibility of application of iron based and organic high polymer based coagulants.

B. Examination of filtration rate

We also studied possibility of realizing rapid filtration at 300 m/day or over, for the purpose of achieving high efficiency.

In addition, composition of filter layer and washing method of filter sand

were also studied.

This test plant, which is located in Fukumasu Purification Plant in Chiba Prefecture, works with a treating system of conventional filtration by coagulation/sedimentation, with a treating capacity of approximately 1,000 m³/day.

This experiment was conducted as a joint study.

The main points which became clear as a result of this experiment are the following:

- Ferric chloride which is an iron based coagulant is sufficiently fit for practical use, because its treating performance is about equivalent or slightly inferior, compared with polyaluminum chloride which is an aluminum based coagulant.
- In the case where an iron based coagulant is used in combination with a high-polymer coagulant, for rapid filtration, the stability improves compared with the case of independent use of an iron based coagulant.
- As for rapid filtration, it was indicated that filtration at a rate of 300 m/day is realizable, except for the season during which the water temperature drops and the season when the amount of algae in the raw water increases.

2) "Effective purification of water from river and tributary water sources" studied by Study Group No. 2.

The tasks or countermeasures to be solved or taken for raw water from river and tributary water sources are basically the same as those in the case of raw water from lake, marsh and reservoir water sources, as far as the problems of fluctuations of raw water quality or cryptosporidium are concerned.

However, the raw water from river and tributary water sources is characterized by large fluctuations of water temperature and sudden change of water quality due to precipitation or melting of snow.

Study Group No. 2 also studied treatment made by combination of a conventional treating system with membrane filtration process, from the viewpoint of improvement of efficiency.

The test plant, which is located in Murano Purification Plant in Osaka Prefecture, also works with a treating system of conventional filtration by coagulation/sedimentation, with a treating capacity of approximately 2,000 m³/day.

This experiment was also conducted as a joint study.

The main points which became clear as a result of this experiment are the following:

- Adding a high-polymer coagulant to ferric chloride, it can make a treatment equivalent to that by polyaluminum chloride.
- As filtration rate, a rate of 350 m/d can be achieved during a period of high water temperature and a rate of 250 m/d during a period of low water temperature, under the standard conditions of 48-hour continuous filtration and turbidity of treated water of 0.1 degree (approximately 0.01NTU)or under.
- As for combination of membrane filtration process with conventional treating system, we found that good water quality can be obtained with a high flux (flow rate) of membrane filtration.

In addition, there are other experiments for improvement of efficiency conducted as individual studies by Study Group No. 1 and Study Group No. 2 as follows:

- Development of efficient underdrain system.
- Study of counter-current dissolved air flotation/filtration process.
- Coarse filtration using fiber filter medium.
- Acti-Flow process. This process adds sand to the water treatment as a coagulation process. This sand settles dirt suspended particles and bacteria.
- Combination with efficient biological treatment.

Also in each of those experiments of new technology, more efficient treatment could be made compared with the conventional treating system.

3) "Application of new membrane filtration technology" studied by Study Group No. 3.

Membrane filtration technology is believed to be the purification technology which will constitute the main stream in the 21st century.

On the other hand, we may also mention the following points as problems to be solved for its application to new fields:

- Problem of stability of operation, for enabling long-term operation by controlling fouling of membrane.
- Realization of high flux (flow rate).
- Technology enabling not only removal of turbidity and disinfection but also removal of soluble matters such as organic matters, substances with foul smell, etc.
- Application to large-scale purification plants also forms a subject of

study for the future, because membrane filtration facilities are adopted mainly in small-scale purification plants in Japan today. (Introducing situation as of June, 2002: 280 places, about 137 thousand m³/day)

On those points, we made the following studies:

- A. We studied reduction of substances causing fouling with pretreatment and, as study for removing soluble matters, studied application of coagulation/sedimentation and fiber filtration, biological activated carbon, pre-ozone treatment, etc.
- B. As study of membrane filtration process itself, we developed vibration type membrane separator and membrane materials such as ozone resistant membrane, ceramic membrane, polyvinylidene fluoride membrane, etc. and studied stability of operation of NF membrane, etc.

Those studies expanded possibility of application of membrane filtration technology to new fields.

4) "Development and practical use of alternative disinfection" studied by Study Group No. 4.

At present, chlorination is legally obligated for potable water supply in Japan for the advantages of accurate treating effect and residual property, etc.

In recent years, however, a problem of disinfection by-product such as trihalomethane, etc. was actualized, with the progress of pollution by organic matters of water sources for potable water supply.

Moreover, for protection against chlorine resistant pathogens such as cryptosporidium, etc., putting to practical use of disinfection technology using substitute disinfectant for chlorine has become an important task.

For that reason, we studied disinfecting effect, method of application, equipment specifications, cost, etc., on chlorine dioxide, chloramine, UV, and ozone which are substitute disinfectants, combination of a plural number of disinfectants, and physical removal of pathogens, from the viewpoints of the following.

- Establishment of pathogen control system.
- Establishment of individual disinfection technologies.
- Establishment of disinfection system also applicable to water supply and distribution systems.
- Protective measures against newly produced and/or revived microbes.
- Positioning of oxidizing in purification of water as disinfection system.

To be concrete, we conducted studies as follows:

- A study regarding putting to practical use of ultraviolet ray, chlorine dioxide, chloramine and ozone.
- A study on the method for removing cryptosporidium in waste water by filter washing.
- A study regarding disinfection with sodium hypochlorite generated at high concentration.
- A study on technology for removing microbes leaking out from granular activated carbon filter, etc.

By collecting the achievements of this Study Group No. 4, we prepared a practical document entitled "Manual regarding putting to practical use of substitute disinfectant".

We believe this manual will help promote putting to practical use of disinfectants other than those by chlorination.

5) "Efficient disposal of drainage from water treatment plants" studied by Study Group No. 5.

As current problems in waste water treatment at purification plants in Japan, we may enumerate as follows:

- Increase of volume of sludge due to increase of volume of coagulant used in purification, and difficulty of waste water treatment due to poor condensability.
- Limited capacity in the place of disposal.
- Necessity of methods for treatment & disposal taking account of energy saving and material circulation, etc.

For that reason, this group conducted the following studies:

- Research on the quality of returned water.
- Development of condensing & treating technology by membrane filtration.
- Protective measures against cryptosporidium in waste water treatment.
- Study of waste water treating system introducing new energy.

Those studies led to development of an efficient treating technology with load-reduction for environment.

6) "Methods for diagnosis and improvement of water treatment facilities" studied by Study Group No. 6.

Study Group No. 6 set a target of presenting methods for diagnosis of functions and improvement which are practical and easy to understand, by

making a general study on the renewal and improvement of purification facilities constituting the background of this project.

As changes in the social situation surrounding the water industry today, we may mention increase of demands for renewal and requests for diversification and sophistication of water services, improvement of business efficiency, reduction of environmental load, etc.

We therefore studied ideal way for managing functions of purification facilities, at the same time, considering the fact that those wide variety of tasks and targets vary depending on the situation and conditions at the respective water utilities, we collected cases of diagnosis widely, not only on functional diagnosis of water facilities based on arguments from the viewpoint of engineering, but also on water business as a whole including finance, and prepared a "Collection of cases of diagnosis and evaluation of water business".

Furthermore, we also prepared a "Collection of data on purification facilities", for the purpose of supplying information on purification facilities useful for improvement of efficiency to make up for depression of functions of purification facilities.

Those "Collection of cases" and "Collection of data" make it possible for the respective water utilities to select optimal methods of diagnosis and evaluation.

7) "Improvement of measuring and control instruments at treatment plants" studied by Study Group No. 7.

As for measuring & control technologies in recent times, a variety of equipment and systems are developed with electronic control in particular as nucleus, and introduced in a wide variety of technical fields.

Various technological reforms using electronic equipment are being made also in water purification plants. However, measuring & control technologies are introduced in a way to be added to purification technology in many cases and, for that reason, it also produces some negative effects such as troublesome maintenance control, complication of management and control systems, cost increase, etc.

To solve such problems, Study Group No. 7 intended to promote labor saving in management, high reliability, stability, and reduction in size of facilities, by utilizing latest measuring & control technologies.

To be concrete, new measuring & control technologies have been developed, through evaluation of basic performances of low-concentration turbidimeter and study regarding continuous measurement of chlorine dioxide and chlorous acid ion.

Moreover, as study for the entire Study Group No. 7, a study was made on the building of a water facilities operation system fully utilizing information technology.

4. Conclusion

The 5-year study for development of high-efficiency purification technology was completed, and a meeting for announcing its achievements was held in this July. Those achievements are planned to be published by the end of the current fiscal year under the title of "New Purification Technologies".

About the influences which those achievements may eventually have on the water services in Japan, we are considering as follows:

The degree of freedom in the design of water facilities greatly expanded and much of the restrictions on introduction of new technologies were abolished, with the enforcement in 2000 of "Ordinance stipulating technical standards of water supply facilities (water supply facility standards)", the contents of which became performance standards. As a result, the chance for putting to practical use of the research achievements of ACT21 became very large and, in fact, we have already received inquiries accompanying concrete facility plans from several water utilities.

We expect that selection of new technologies will be made also in the future, and wish to continue working with new projects, on problems which remained unsolved in ACT21.

23. New Trends Of Advanced Wastewater Treatment
(biotechnology / membranes)

Presenter

Dr. Haruki WATANABE, Japan Sewage Works Agency

NEW TRENDS OF ADVANCED WASTEWATER TREATMENT (biotechnology /membranes)

H. Watanabe, M. Wakayama, H. Itokawa, T. Murakami, F. Suzuki

Research and Technology Development Division
Japan Sewage Works Agency
5141 Shimosasame, Toda, Saitama 335-0037, Japan

ABSTRACT

The public sewerage system in Japan has developed rapidly in the past decade in terms of downsizing and advanced wastewater treatment. Many of the small-scale treatment plants use the oxidation ditch process owing to the easy maintenance of the facilities. The main methods of advanced treatment are the rapid filtration process and the biological nitrogen removal process with the addition of coagulant. This paper describes the submerged membrane bioreactor and the step feed multistage denitrification-nitrification process, both of which have attracted attention as new treatment technologies. Regarding the submerged membrane bioreactor, pilot-plant experiments were conducted for varying sewage influent flow. The experiments proved that up to three-fold variations in average daily flow can be normalized in the process by changing flux and water level of the bioreactor. As for the step feed multistage denitrification-nitrification process, the study was conducted using full-scale plant which has a combination of three-stage anoxic-oxic reactors over ten months. The study revealed that the nitrogen removal efficiency reached 89% on average.

KEYWORDS

Advanced Wastewater Treatment, Submerged Membrane Bioreactor, Organic and Nutrient Removal, Anoxic-Oxic Reactor, Step Feed, Activated Sludge

INTRODUCTION

Japan introduced the activated sludge process in 1930 as sewage treatment process. Thereafter, sewerage construction was conducted mainly on large cities. Large investment for sewerage construction, however, began in the late 1970s when the pollution of public water bodies caused by industrial wastewater and other contaminant sources became a serious social problem and when water quality conservation at public water bodies was added to the objectives of sewerage service. The percentage of sewered population at the end of fiscal year (FY) 1970 was only 16%. The percentage, however, increased to 30% at the end of FY 1980, 44% at the end of FY 1990, and 62% at the end of FY 2000¹⁾, showing steady development in

the last thirty years. The number of public sewage treatment plants (PSTPs) constructed by the end of FY 2000 stood at about 1,500. Advanced treatment of sewage is performed to prevent eutrophication in closed sea areas such as Tokyo Bay and at lakes and marshes, and also to conserve the quality of water supply sources. The percentage of sewered population served by advanced treatment stood at 8% at the end of FY 2000.

PUBLIC SEWAGE TREATMENT PLANT IN JAPAN

Figure 1 shows the number of PSTPs in operation by type of treatment process in each fiscal year. The total number of PSTPs in FY 1980 was 457, giving a sewered population of 30%. In that year, the conventional activated sludge process accounted for 65% of all processes. Since the conventional activated sludge process involves difficult maintenance, even though the process achieves high treatment efficiency per unit area, the districts serving sewerage before 1980 were rather limited to large cities where sewerage engineers were available.

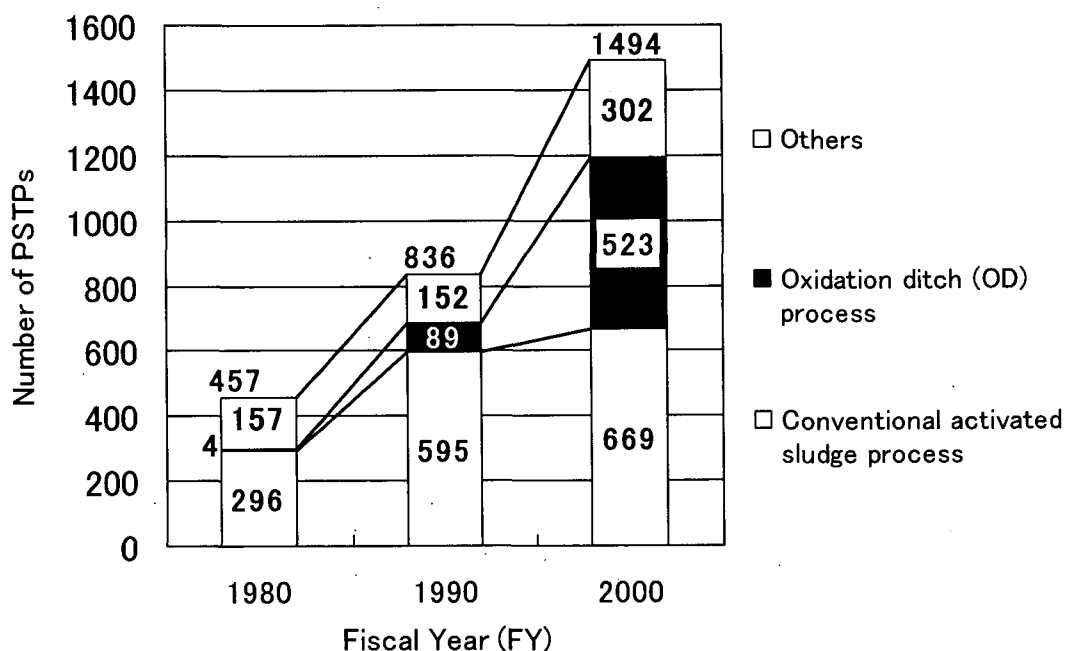

Figure 1. Treatment methods of PSTPs

Ten years later, in FY 1990, the number of treatment plants reached 836, an 83% increase, and the percentage of sewered population increased to 44%. The number of plants which adopted the conventional activated sludge process increased to 595, suggesting that sewerage construction was focused on urban districts. Also the oxidation ditch (OD) process, and involves easy maintenance and is suitable for small-scale plants, was constructed at 89 plants. In FY 2000, the total number of treatment plants increased to 1,494, and the percentage of sewered population

increased to 62%. As for the sewage treatment processes in FY 2000, the conventional activated sludge process accounted for 45%, the OD process for 35%, and others 20%. Between 1991 to 2000, the OD process showed a significant increase, which suggests that the sewage treatment system proliferated rapidly in small and medium-sized towns and villages.

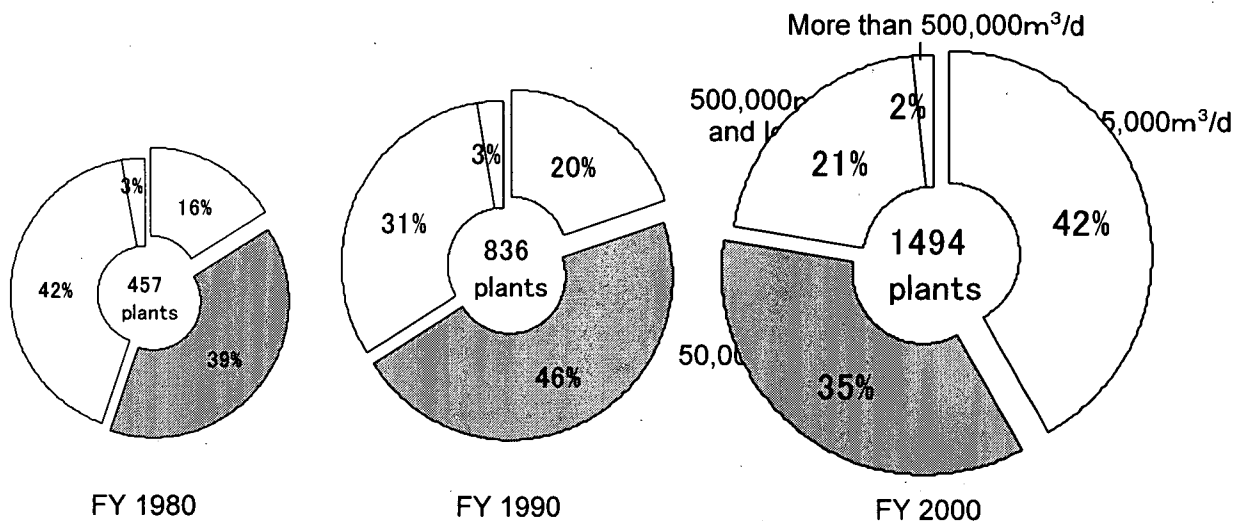

Figure 2. Design capacity of PSTPs

Figure 2 shows the number of PSTPs in FY 1980, FY 1990, and FY 2000, by design capacity. The number of plants having capacities of less than 5,000 m³/day was 73, 164, and 627 in FY 1980, FY 1990, and FY 2000, respectively. The number of plants having capacities of 5,000 m³/day up to 50,000 m³/day was 180, 388, and 531, respectively. Thus, the total number of plants having capacities of up to 50,000 m³/day was 253 (accounting for 55% of the total), 552 (66%), and 1,158 (77%), showing that the construction of small-scale treatment plants rapidly increased during the twenty years. As shown, significant features of Japanese sewage treatment system during the decade are the adoption of the OD process and the rapid downsizing of the treatment plants.

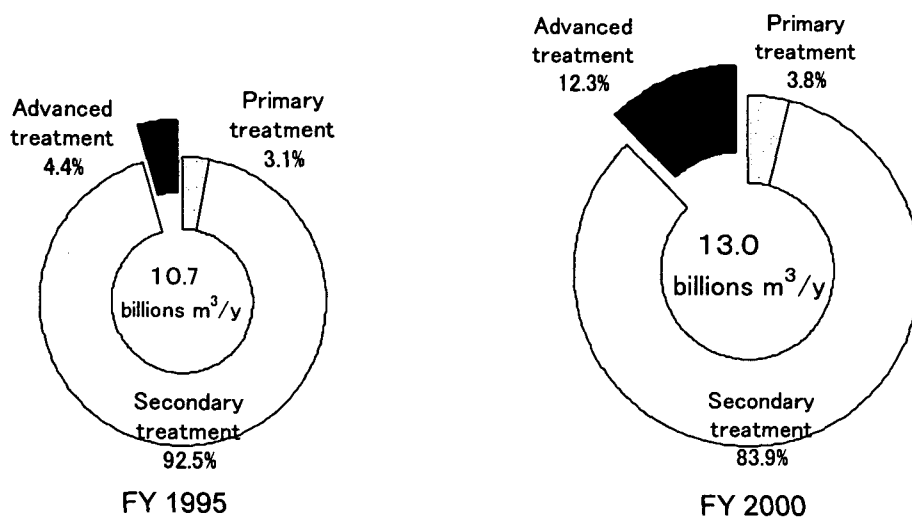

Figure 3. Annual treated wastewater by PSTPs

There are several types of advanced treatment process, such as the rapid filtration process which removes mainly organic matter and suspended solids, the biological nitrogen removal process with adding inorganic coagulant to remove nitrogen and phosphorus, and a method combining these processes. Figure 3 shows the annual treatment volumes of primary effluent, secondary effluent, and advanced effluent²⁾. In FY 1995, 10.7 billion cubic meters of sewage was treated, of which 3.1% was primary effluent, 92.5% secondary effluent, and 4.4% advanced effluent of the total. In FY 2000, 13.0 billion cubic meters of sewage was treated, of which 3.8% was primary effluent, 83.9% secondary effluent, and 12.3% advanced effluent of the total. The number of plants using the advanced treatment process rapidly increased in Japan in these five years, reaching 178 plants in FY 2000. Of these 178 plants, 75 plants adopted the biological nitrogen removal process, including 16 plants which adopted the recycled nitrification-denitrification process, 3 plants the nitrification-denitrification using endogenous respiration process, 9 plants the anaerobic-anoxic oxic process, and 47 plants the anaerobic-oxic activated sludge process. 93 plants introduced the rapid filtration process. Nevertheless, the present rate of advanced treatment process applied in Japan is significantly lower than that of Western countries. Advanced treatment needs to be further promoted around rivers, lakes and bay areas, particularly at areas where water quality must be conserved.

MEMBRANE BIOREACTOR

Membrane bioreactor (MBR) applies membrane separation technology to activated sludge process for wastewater. A distinctive difference between activated sludge process and MBR is that the solid-liquid separation of activated sludge process basically utilizes gravity sedimentation, while MBR conducts solid-liquid separation by membrane in bioreactor. Compared with activated sludge process, MBR has the following advantages.

- 1) No secondary clarifier is needed.
- 2) Since the sludge concentration in MBR can be increased, the reactor volume can be reduced, nitrogen removal can be achieved by relatively small facility and no sludge thickener is necessary.
- 3) Solid-liquid separation is not hindered, such as by bulking.
- 4) Protozoa and infectious bacteria are likely to be removed.

Yamamoto³⁾ reported that sludge retention time (SRT) can be extended so that biologically hard organics can be decomposed by microorganisms. With these advantages, membrane separation technology began to be used in the 1990s for night soil treatment, industrial wastewater treatment, combined septic tanks, and other uses.

Application to PSTP

In the public sewerage field, however, MBR process is still at the stage of extensive experiments using pilot plants. The reasons for delayed application in the field are high cost of membrane, high maintenance cost, and poor advantage of scale merits in commercial facilities. In addition to these drawbacks, the reason specific to public sewerage is namely the response of membrane to fluctuation of sewage influent. Public sewerage faces significant variations in sewage inflow during a day depending on human lifestyles. Furthermore, even separate sewer system may be influenced by storm water inflow. Therefore, it is important to know the degree to which MBR process can adjust to variations in sewage influent. The paper describes the results of pilot experiments on variations in influent.

Figure 4 shows the flow diagram of the pilot plant. To remove nitrogen, activated sludge reactor is divided into oxic tank and anoxic tank. The sludge is recycled from oxic tank to anoxic tank. To remove phosphorus, polyaluminum chloride (PAC) is added to oxic tank.

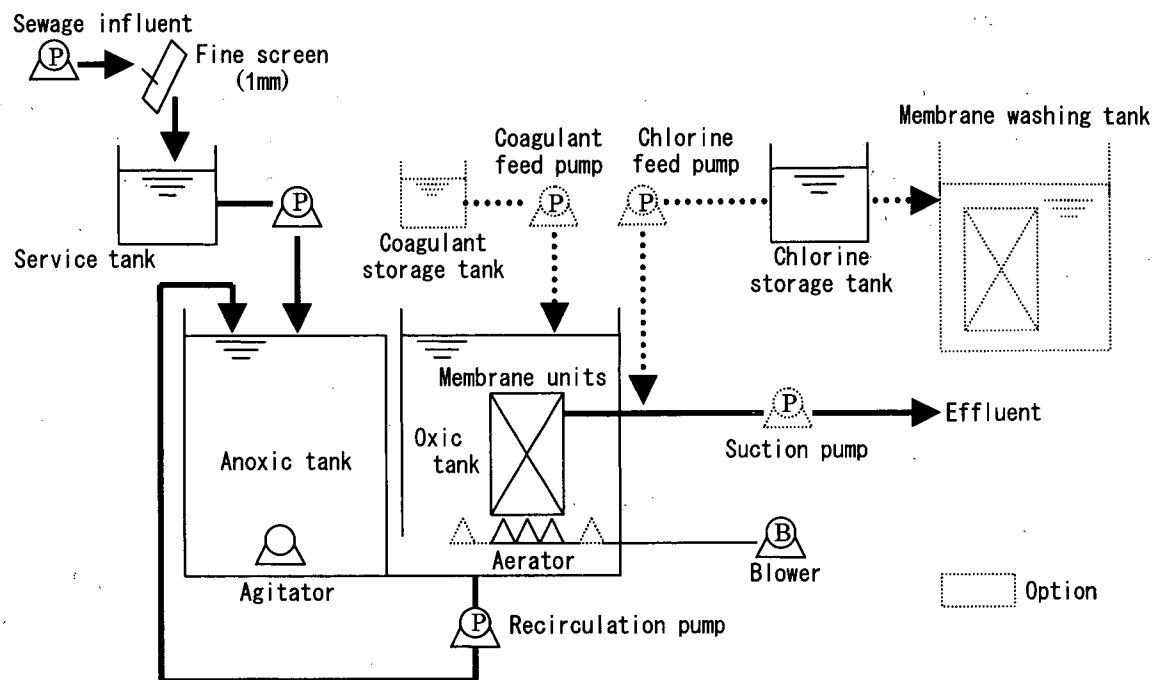

Figure 4. Flow diagram of the pilot plant

Six kinds of membrane were used in the experiment: three kinds of flat film, two kinds of hollow fiber, and one kind of ceramic membrane. The specifications of each membrane are given in Table 1.

Table 1. Membrane Specification

	A			B	C	D
	A-1	A-2	A-3			
Membrane	Flat film		Ceramic	Hollow fiber	Flat film	Hollow fiber
Pore size (μm)	0.4		0.1	0.1	0.4	0.4
Membrane surface area (m^2)	60	80	50.6	92	80	126
Filtration system	Gravity	Pump	Pump	Pump	Pump	Gravity /Pump

The operating conditions of the pilot plant are given below:

- Sewage influent: Influent of primary clarifier coming from separate sewer system
- Pattern of inflow: 4 patterns (Figure 5)
- HRT at anoxic tank: 3 hours
- HRT at oxic tank: 3 hours
- Air to flow rate: 18 to 30 fold
- Membrane flux: 0.4 to 0.8 m³/m²·d

Table 2. Water quality of influent sewage

	BOD (mg/l)	COD _{Mn} (mg/l)	TOC (mg/l)	SS (mg/l)	T-N (mg/l)	T-P (mg/l)	Coliform group number (number/ml)
Av.	172	111	103	217	37.8	5.9	3.3E+05
Max.	313	278	197	490	63.3	13.1	7.0E+05
Min.	92	52.5	35.5	72	23.3	2.74	3.0E+04

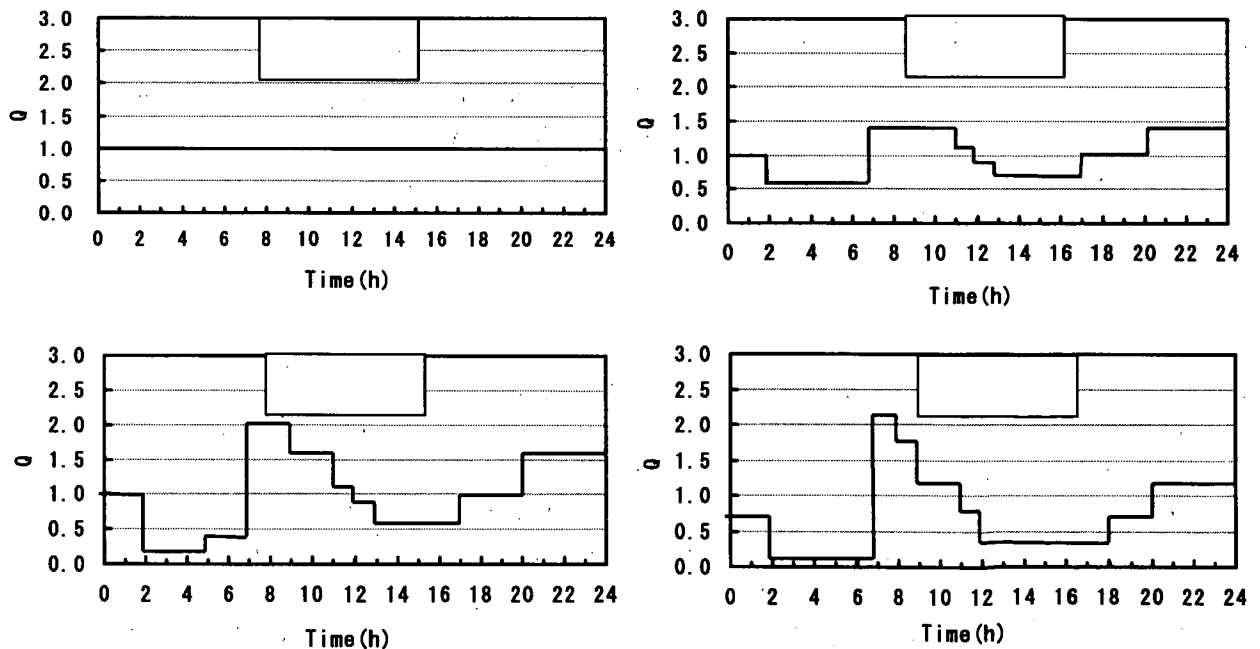

Figure 5. Influent flow diagram of the pilot plant

The inflow pattern RUN 1 fixed sewage influent flow for 24-hour. For RUN 2, sewage influent was set to 1.5 of average daily flow at peak time assuming inflow pattern at large treatment plant. For RUN 3, sewage influent was set to 2 times of average daily flow assuming medium-scale treatment plant. For RUN 4, sewage influent was set to 3 times of average daily flow assuming small-scale treatment plant. Generally, MBR process is considered to operate under the continuous filtration of fixed flow for preventing transmembrane pressure higher. Nevertheless, in the experiment the inflow was varied to study the response of membrane flux and the ease of maintenance.

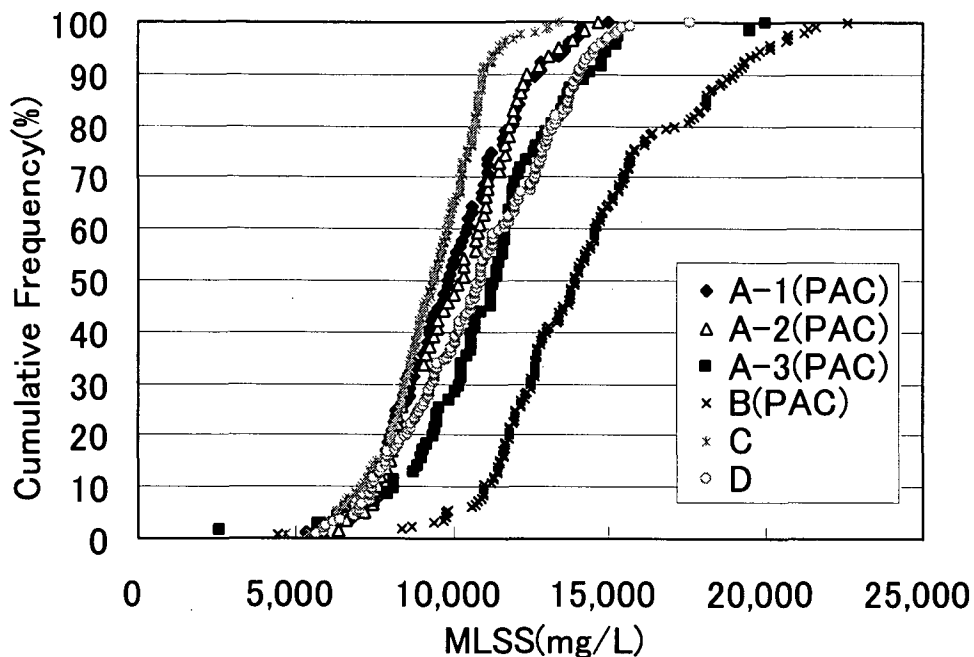

Figure 6. MLSS concentration in the experimental

Figure 6 shows the cumulative frequency of MLSS during the experiment. Data of Figure 6 include four plants (A-1, A-2, A-3, and B) in which PAC was added to remove phosphorus, and two plants (C and D) which were operated without PAC. During the experiment, MLSS concentration was varied from 5,000 mg/l to 20,000 mg/l, though the range was differed in each plant, and the flux expected was attained at all levels of MLSS concentration. However the higher the MLSS concentration is, the higher the viscosity of sludge is. Regarding the influence of high MLSS concentration, there was concern about agitation in the reactor and air diffusion efficiency. As a result, it was confirmed that practical operation should be conducted at MLSS concentration, of around 10,000 mg/l, assuming that SRT needed for nitrification is maintained.

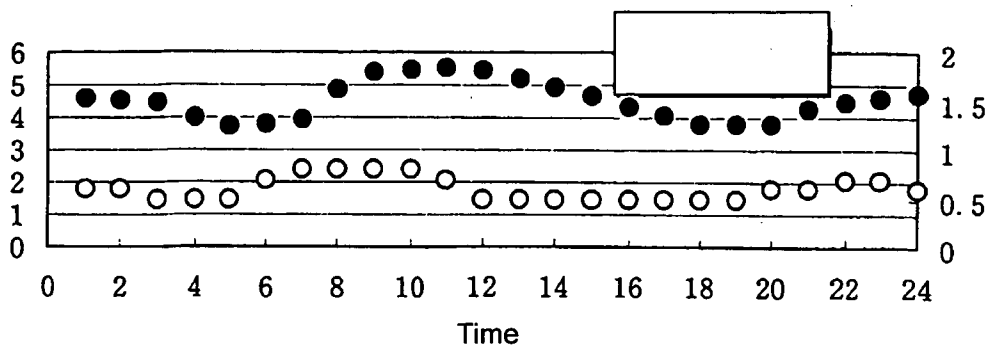

Figure 7. Variation of flux and water level in RUN4 (plant C)

In RUN 4 setting the largest variations of inflow in the experiment, it was confirmed that the variation can be normalized in the process by changing flux and water level of the reactor tank, as shown in Figure 7. Further investigation, however, is needed to confirm stable operation for responding the variation of inflow.

Large variation of flux should also be considered carefully because it causes the increase of transmembrane pressure rapidly and the increase of frequent washing of membrane, though the permissible variation differs with the characteristics of each membrane and with each system. For instance, plant B in RUN 4 was operated by applying flux changes (0.6 to $1.6 \text{ m}^3/\text{m}^2 \cdot \text{d}$) mainly and performed injection washing of sodium hypochlorite once a week. On the other hand, plants C and plant D, which mainly applied water level variation while minimizing flux changes, performed injection washing every two or three months.

The water quality of effluents was stable over the whole experimental period, achieving high removal rate of 99% for BOD, 91 to 93% for COD_{Mn} , and around 94% for TOC. Also for SS and coliform group number, most of the data were below the detection limit, thus obtaining very clean effluent.

Regarding biological nitrogen removal, T-N of effluents was less than 10 mg/l at recirculation rate of nitrified mixed liquor of 300%. For phosphorus removal, the simultaneous coagulation process adding PAC to the oxic tank gave less than 0.5 mg/l of T-P in effluents. For phosphorus, however, a plant stably achieved less than 0.5 mg/l of T-P in effluent even without adding PAC.

For practical application of MBR, the themes remaining to be solved are (i) the performance of membrane filtration during the period of low water temperature, (ii) reducing maintenance cost for washing and aeration power of membrane.

STEP FEED MULTISTAGE DENITRIFICATION-NITRIFICATION PROCESS

Figure 8⁴⁾ summarizes the target concentration of nitrogen in the effluent of treatment plants which operate advanced treatment. The target T-N concentration of 10 mg/l for effluent is adopted by many plants. Some of the plants, however, adopt 5 mg/l or lower concentrations in response to strict water quality targets for advanced effluent.

A treatment process that attains high nitrogen removal efficiency at low investment and maintenance cost is therefore required. The step feed multistage denitrification-nitrification process (SMDN process) is one process that satisfies the requirements.

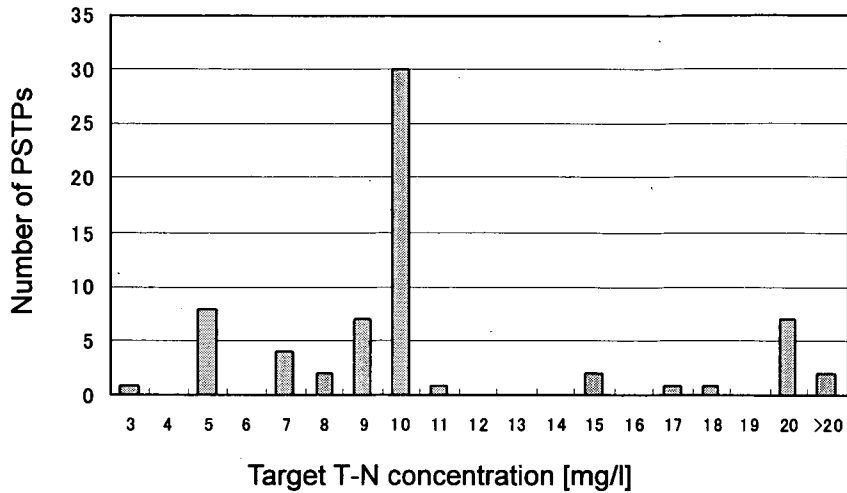

Figure 8. Target T-N concentration advanced effluent

A schematic diagram of the SMDN process is shown in Figure 9. It is characterized by (i) several stages of anoxic and oxic reactors in series, each reactor being completely mixed preferably, (ii) a uniform distribution of the influent wastewater to all the anoxic reactors, (iii) a reactor volume configuration which makes the mass of MLSS in each stage the same, and (iv) internal recycle of nitrified mixed liquor in each stage by airlift effect (if needed). By employing multistage of anoxic-oxic reactors, high nitrogen removal efficiency with smaller reactor volume can be achieved without mixed liquor recycle, as a feature of step feed processes.

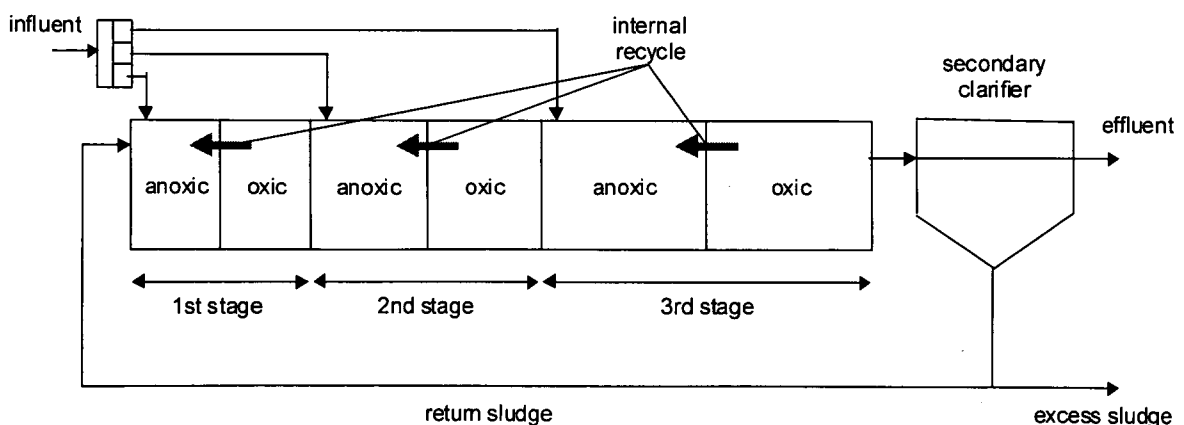

Figure 9. Schematic diagram of three stage SMDN process with internal recycle of nitrified mixed liquor.

With this process configuration, maximum nitrogen removal efficiency due to denitrification ($\eta_{DN,max}$) is decided by three parameters, the number of stages (N), sludge recycle ratio (r), and internal recycle ratio of the last stage (R_N), as shown in Eq.(1) which assumes complete nitrification and denitrification in oxic and anoxic reactors, respectively.

$$\eta_{DN,max} = 1 - \frac{1}{N} \cdot \frac{1}{1+r+R_N} \quad (1)$$

The $\eta_{DN,max}$ values of three and two stage SMDN process are 78% and 67%, respectively, under the condition of 0.5 of sludge recycle ratio and no internal recycle (Table 1). These correspond to the overall recycle ratios of 3.5 and 2.0, respectively, in a single stage anoxic-oxic process. The total reactor volume could be reduced by 22% and 17%, respectively, in comparison with a single stage process, assuming fixed ratio of anoxic to oxic reactor volume (V_{DN}/V_O ratio). As shown in Eq.(1), nitrogen removal can be improved by carrying out the internal recycle in the last stage.

Full-scale three/two stage SMDN process

Operating condition and average performance of Plant A and B during the survey period are summarised in Table 3. In both plants, nearly the designed values of wastewater were treated during the period, the total HRTs being 17.6hr and 9.3hr, respectively. A baffle wall with a channel at the bottom was installed between the reactors, thereby each reactor could be regarded as a separate compartment. One to four windows were opened on the baffle walls near the surface of the mixed liquor, and internal recycle was carried out by airlift from oxic reactors to the preceding anoxic reactors. Submerged mechanical aerator was installed in all the reactors, and DO was controlled at 2 mg/l in oxic reactors by changing the rotation rate of the aerators. PAC was added to the last oxic reactor at the rates of 4.3 and 2.0 g-Al/m³-influent in Plant A and B, respectively, for chemical precipitation of phosphorus.

Table 3. Averaged operating condition and performance of Plant A and B.

	unit	Plant A		Plant B	
Survey period	-	Jun.99-Mar.00		Jun.99-Feb.00	
No. stages	-	3		2	
Total reactor volume	m ³	13,500		14,500	
V _{DN} /V _O ratio	-	1.0		0.67	
		designed	actual	designed	actual
Min. Temperature	°C	15.0	16.8	-	16.4
Flow rate	m ³ /day	19,700	18,400	40,000	37,200
Sludge recycle ratio	-	0.5	0.5	0.5	0.5
HRT	hr	16.4	17.6	8.7	9.4
SRT	days	19	21	13	13
ASRT	days	9.7	10.6	7.7	7.9
MLSS (last stage)	mg/l	2,000	3,020	3,000	2,410
PAC dose	mg-Al/m ³	-	4.0	-	2.0
		influent	effluent	influent	effluent
SS	mg/l	185	1.5	84	2.1
BOD ₅	mg/l	147	1.4	109	1.8
COD _{Mn}	mg/l	98	6.7	65	7.5
T-N	mgN/l	29.1	2.9	24.6	6.2
NH ₄ -N	mgN/l	19.4	0.1	14.7	0.2
NO ₂ -N	mgN/l	N.D.	0.1	0.1	N.D.
NO ₃ -N	mgN/l	N.D.	1.9	0.1	5.0
T-P	mgP/l	4.25	0.06	3.72	0.55
PO ₄ -P	mgP/l	1.93	0.02	1.38	0.35

The average influent and effluent T-N concentrations were 29 and 2.8 mgN/l for Plant A, and 23 and 5.8 mgN/l for Plant B, overall nitrogen removal efficiencies being 90.3% and 74.8% for Plant A and B, respectively. In Plant A, nitrification proceeded almost completely even in winter, the average effluent NH₄-N concentration was 0.1 mgN/l. In contrast, in Plant B, ammonium was remained in aerobic reactors temporary in winter, possibly due to the insufficient Aerobic SRT for nitrifiers' growth.

Nitrogen removal efficiency due to denitrification ($\eta_{DN,actual}$) was calculated by Eq.(2),

$$\eta_{DN,actual} = 1 - \frac{N_{total,out} - N_{org,out}}{N_{total,in} - N_{org,out} - N_{total,waste}} \quad (2)$$

where $N_{total,in}$ and $N_{total,out}$ are the amount of influent and effluent total nitrogen, respectively, $N_{org,out}$ is the amount of effluent organic nitrogen, and $N_{total,waste}$ is the amount of total nitrogen removed by excess sludge. This modified efficiency is based on the amount of effluent inorganic nitrogen divided by the amount of nitrogen to be nitrified, and this permits a direct comparison with the $\eta_{DN,max}$ value expressed by Eq.(1). For Plant A, the average $\eta_{DN,actual}$ value was 88% (Figure 10(a)), obviously higher than the $\eta_{DN,max}$ value expected by the three stage SMDN process

without internal recycle (78%). Using the $\eta_{DN,actual}$ value and Eq.(1), actual internal recycle ratio of the third stage (R_N) was estimated to be in a range of 1.0 to 2.0. For Plant B, the $\eta_{DN,actual}$ value was calculated to be 74% on average (Figure 10(b)), also higher than the $\eta_{DN,max}$ value without taking internal recycle into account (67%). While the data fluctuated more than that of Plant A, an expected R_N value was 1.1 on average.

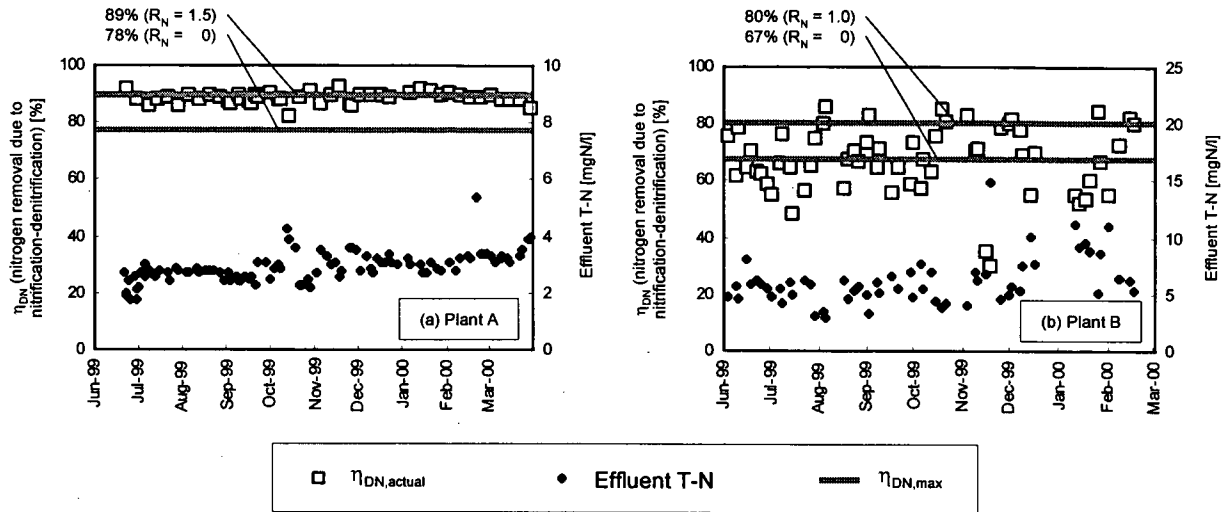

Figure 10. Nitrogen removal efficiency due to denitrification in Plant A and B.

CONCLUSION

The percentage of public sewerage population in Japan stood at 62% at the end of FY 2000, and public sewerage was mainly served in densely populated districts. The percentage of wastewater treatment population as the sum of agricultural village wastewater treatment and combined septic tanks, which are promoted at less densely populated districts, and public sewerage is 71%. Since sewerage construction will proceed in less densely populated districts, the cost of construction, operation and maintenance of wastewater treatment plants must be reduced, and maintenance must be simplified. In addition, advanced treatment is required for preventing eutrophication in closed water bodies and for conserving the quality of water supply sources. The MBR and the step feed multistage denitrification-nitrification process, which are described in this paper, are expected to be applied in practice to meet such requirements.

REFERENCE

- 1) Ministry of Land, Infrastructure and Transport "Public Sewerage in Japan, FY

- 2002”, Japan Sewage Works Association, 2001 (in Japanese)
- 2) “Outline of Public Sewerage Statistics, FY 2000”, Japan Sewage Works Association, 2002 (in Japanese)
 - 3) Kazuo Yamamoto, “New Wastewater Treatment Technology using Membrane Separation Process”, Jour. of Water and Waste, Vol. 41, No. 5, 1999 (in Japanese)
 - 4) “Public Sewerage Statistics FY 1999 – Administration”, Japan Sewage Works Association, 2001 (in Japanese)

24. New Treatment Trends : Membranes and Biotechnology

Presenter

**John Novak, Virginia Polytechnic Institute
& State University**

New Treatment Trends: Membranes and Biotechnology

John Novak, Ph.D., P.E.
Virginia Tech

New Technology—Drivers

- Space: new technologies can provide more capacity on a smaller footprint
- Regulations: government authorities are becoming increasingly strict about nutrients entering receiving waters
- Reuse: as freshwater becomes more limited, reuse of wastewater will become more common

Membrane Projects

Note: WERF is not working on membrane development, but on application, design and operation, cost, and residuals issues.

Many membrane projects may result in cost savings in terms of system efficiency or increased capacity.

Membrane Projects: Footprint and/or Cost Reduction

- autotrophic denitrification using membranes for hydrogen delivery (00-CTS-14ET);
- membrane-aerated bioreactor system (00-CTS-11);
- membranes for reuse of secondary effluent (01-CTS-6),

Membrane Projects: Footprint and/or Cost Reduction

- membrane pre-filter (01-CTS-31ET);
- membrane tools for applicability and sizing (00-CTS-8);
- anaerobic membrane bioreactors (02-CTS-4);
- membrane fouling and sludge characteristics (01-CTS-19UR).

Membrane Projects

Membranes assist in the production of high-quality effluents by replacing or supplementing traditional effluent polishing.

Membrane Projects: High-quality Effluent and Direct Reuse

- membranes for reuse of secondary effluent (01-CTS-6),
- membrane tools for applicability and sizing (00-CTS-8);
- membrane bioreactors for water reclamation (98-CTS-5)

Membrane Projects—Highlights

00-CTS-8: will produce tools that will assist plant managers in deciding whether membranes for solid-liquid separation are appropriate at their plant and will provide help in initial sizing.

Membrane Projects—Highlights

00-CTS-11: will further research in membrane-aerated bioreactors by characterizing the biofilm, testing whether they support denitrification, and improving start-up. Has been shown to result in lower aeration costs.

Biotechnology Projects

Various biotechnologies are being developed to improve the quality of the final effluent.

Biotechnology Projects: Quality Maintenance/ Prevention of Upset

- source-cause-effect relationship (01-CTS-2);
- upset early warning detection workshop (99-WWF-2);
- toxicity screening using a bioluminescent reporter (98-CTS-6);

Biotechnology Projects: Quality Maintenance/ Prevention of Upset

- water quality monitoring with bioluminescent microorganisms (01-WSM-2a);
- upsets in the petroleum industry (98-CTS-3T)

Biotechnology Projects

Biotechnology is aiding in the rapid identification of organisms in order to protect the public and produce a high-quality effluent

Biotechnology Projects: Organism Identification

- new platform technologies (00-HHE-2A);
- quantitative PCR (00-HHE-2B);
- fiber-optic biosensors (00-HHE-2C);
- DNA microarray technology applications (01-HHE-1);

Biotechnology Projects: Organism Identification

- phenotype quantification in biological treatment processes (98-CTS-2);
- real-time PCR (01-HHE-2A);
- microarray technology (01-HHE-2B);
- molecular methods for detection of infectious viruses (99-HHE-5UR);
- hand-held instrument for the rapid identification of pathogens (99-HHE-4ET)

Biotechnology Projects—Highlights

01-CTS-2: investigating the root causes of upset conditions, and how various toxic compounds affect the activated sludge process.

Biotechnology Projects—Highlights

01-HHE-2B: development of microarray technology for pathogen and indicator monitoring will lead to near real time analysis of human health risk. The methods developed may also provide insight into source reduction and contributions to loadings.

Membranes and Biotechnology—Other Research

- AwwaRF has a number of projects dealing with PCR/ RT-PCR and molecular fingerprinting.
- AwwaRF also has several projects related to source and drinking water treatment using ultrafiltration or nanofiltration.
- USBR is sponsoring research in various membrane applications for water reuse and desalination.

Future Directions

- Designation of water as a resource will continue to expand as supplies become more limited, increasing the value of water.
- The use of membranes to generate marketable products from wastewater, such as water for reuse, phosphorus, methane and biosolids, will likely expand.

Future Directions (Continued)

- Efforts need to be made to improve stakeholders' comfort level with the quality of reused water.
- Traditional methods of collection and treatment of wastewater need to be assessed; the expense of repairing and replacing old infrastructure is significant.

Future Directions (Continued)

- The protection of public health by direct measurement of pathogens rather than using indicator organisms deserves further research.
- Treatment for very low levels of nitrogen and phosphorus will become more common.

Future Directions (Continued)

- WERF has funded projects directed toward reducing biomass or selecting for specific treatment capabilities. The issue of biomass characterization will develop more fully as we gain an understanding of biological systems at the molecular level, allowing WERF to support more research in this area if necessary.

Future Directions (Continued)

- A better understanding of the presence and concentration of Hormonally Active Agents and Pharmaceutically Active Compounds in wastewater and effluents needs to be achieved and their fate determined.

**25. Global and Environmental Considerations in Drinking
Water Supply
(Climate Impact / Energy Savings)**

Presenter

Mr. Takashi Sasaki, Hanshin Water Supply Authority

Global and Environmental Considerations in Drinking Water Supply (Climate Impact / Energy Savings)

Takashi SASAKI

Hanshin Water Supply Authority

3-20-1 Nishiokamoto, Kobe, 658-0073 Japan

Tel. 81+78-431-4355 Fax. 81+78-431-2695

E-mail. sasaki-t@hansui.or.jp

1. Need for Global and Environmental Consideration

115 years have passed since Japan's first modern water service system started in Yokohama City, to improve public health and upgrade people's living environment. Today, covering nearly 97% of the country's population, the waterworks has become an infrastructure indispensable to hygienic and comfortable daily life. Recent statistics show that 123 million people consume 17 billion m³ of tap water per year. In other words, the average amount of water supply per person is 380 liters per day, a 3.6% drop from the figure ten years ago; 394 liters.¹⁾

Japan's population growth is expected to reach its peak within a few years and then start to gradually decline afterwards. Looking at the situation surrounding drinking water supply, supply-demand relationship is also on the drastic turning point, as represented by industrial water decline caused by recycling and rainwater use, growing water-saving consciousness, and sluggish household water consumption.

Figure 1 symbolically illustrates the role played by the domestic waterworks. In the 1960s, the public water networks expanded rapidly, resulting in a remarkable drop in the prevalence of waterborne infectious diseases (dysentery, cholera, typhoid, and paratyphoid). In addition to overall enhancement in public health, the waterworks greatly contributed about 2-log elimination in the incidence.

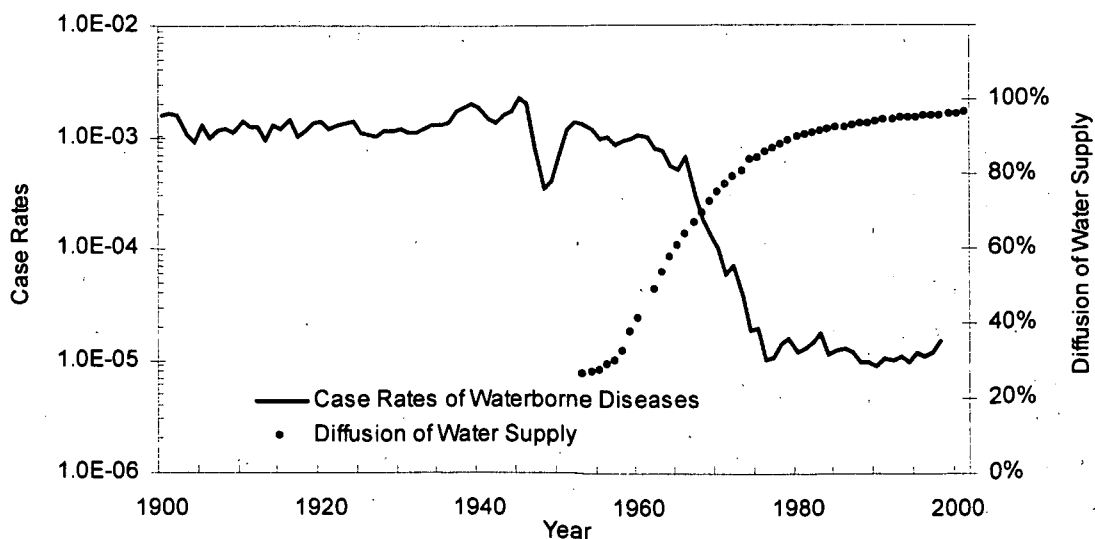

Figure 1 Changes in waterborne diseases and domestic waterworks coverage

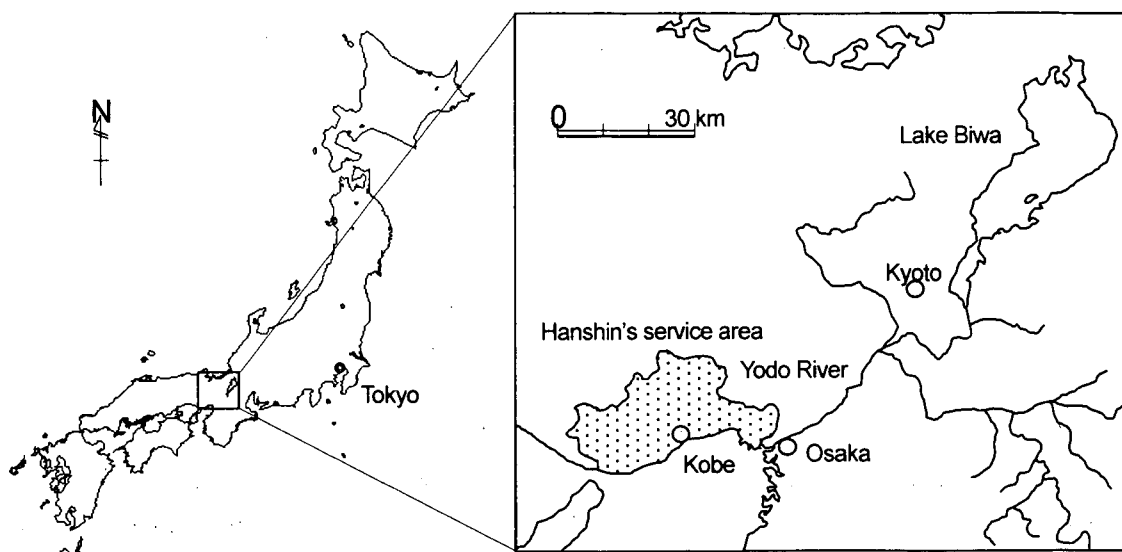

Figure 2-a Outline of Lake Biwa - Yodo River system and Hanshin Water

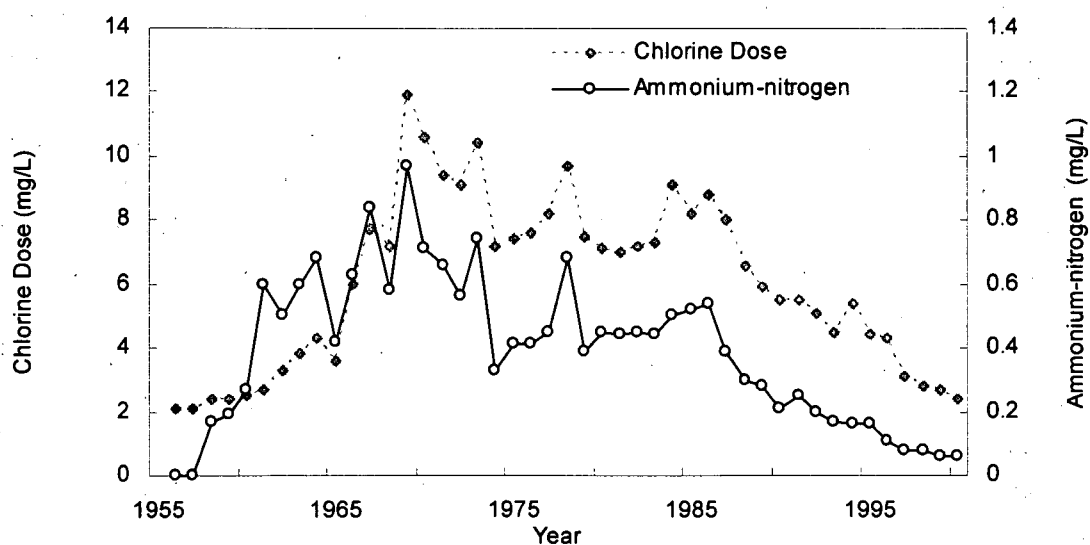

Figure 2-b Changes in raw water quality and chlorine Dosage

Figure 2-a and 2-b indicate annual changes in water quality of the Yodo River, one of representative rivers in Japan, and the average chlorine dosage by the Hanshin Water Supply Authority. Lake Biwa, Japan's largest lake, and the famous city of Kyoto are located at upper reaches of the Yodo River. Therefore, the Yodo River is subject to eutrophication and domestic wastewater, which situation is typical of urban rivers. Around 1960, the ammonium nitrogen began to increase rapidly in the Yodo River, keeping pace with the Japan's rapid economic progress. In 1969, the annual average chlorine dosage reached 12 mg/L. Later, the spread of sewage systems and progress in wastewater treatment technology regained the water quality of pre-deterioration, as far as ammonium nitrogen and chlorine dosage are concerned.

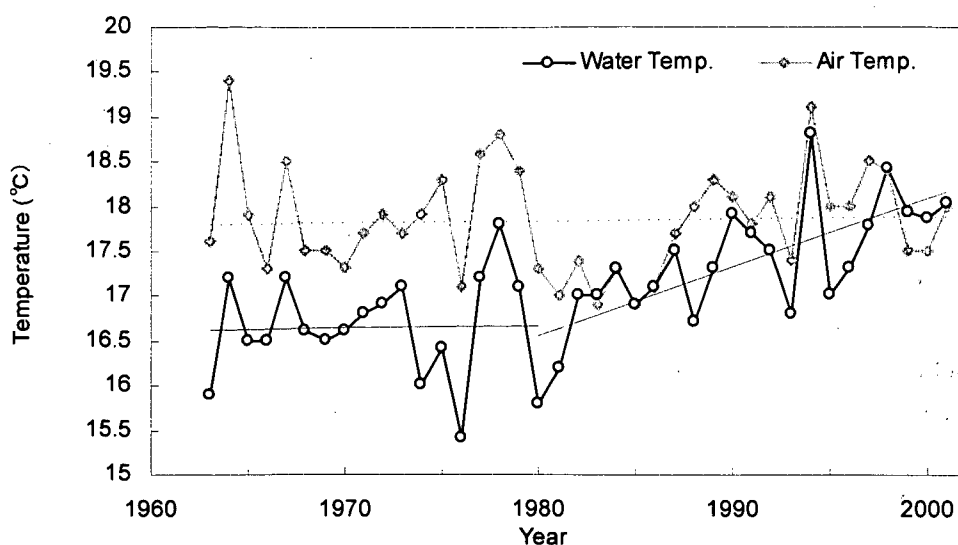

Figure 3 Changes in water and atmospheric temperatures

Figure 3 shows water and atmospheric temperatures over the last 40 years at the Hanshin Water's Inagawa water treatment plant (WTP), which suggests the unprecedented changes in hydrologic cycle in the Yodo River basin. The atmospheric temperatures remain unchanged on the whole except for slight fluctuations, whereas the water temperatures have a tendency to increase over the periods. Dividing the periods into 20-year sub-periods will make it clear. Water temperatures are relatively static in the first 20 years, while they marked 1.5°C increase during the last 20 years. Climbing water temperature itself is of great significance as a sign of global warming, however, attention should also be directed to the difference between water and atmospheric temperatures. Although ranged from 1 to 2°C until around 1980, the difference has been disappearing in recent years. The author assumes that some sort of unnatural hydrologic cycle causes short circuit, which flows ground surface susceptible to the atmospheric temperature. Short circuit flow can, simply put, trigger drought or flooding.

In the face of diversifying socio-economic structures, creeping global warming, and unnatural hydrologic cycle, the water service system, which has fulfilled its initial missions, should pay attention to global environmental considerations as a matured infrastructure. This is because tap water is nothing but the most accessible water to people today edging away from natural waterside. Based on mutual partnership, the water suppliers and customers should share the common understanding on climate impact and importance of energy saving via tap water, as well as creating new strategies to conserve source water quality, sustain water resources, and re-establish natural hydrologic cycle. In this paper, Chapters 2 and 3 respectively introduce the Hanshin Water and other utilities' efforts concerning global environmental consideration, followed by Chapters 4 in which the author intends to find out a clue to future orientation.

2. Efforts of the Hanshin Water

The Hanshin Water is a drinking water supply utility serving 2.5 million people in four cities, including Kobe. It is the oldest wholesome authority of this kind in Japan. The authority intakes from the Yodo River to its two water treatment plants: the main Inagawa WTP (916,900 m³/d) and the Amagasaki WTP (373,000 m³/d) with leading-edge technology. From 1993 to 2001, to better cope with diversifying source water quality, advanced water treatment technology were introduced, mainly featuring mid-ozonation and granular activated carbon-fluidized bed (GAC-FB) adsorption. Aqueducts and transmission mains stretch 183 km, and a large amount of water is pumped up to nearly 100 m.

In this chapter, the author presents environmental measures taken by the Hanshin Water, such as energy conservation, carbon dioxide (CO₂) discharge reduction, recycling of wastes during treatment processes, and environmental-oriented designing.

2-1. Energy conservation

(1) Transmission and distribution facilities

Among the water supply processes, water transportation consumes much of the total energy, 80% of which is used for pumps. Since pump motive power depends on the cubed revolving speed, controlling the revolving speed is highly effective in reducing energy consumption. The Hanshin Water has been active in introducing revolving speed control pumps since the 1960s. More recently, in the wake of progress in the revolving speed control, the utility has been switching from conventional Scherbius system to the inverter system, which is superior to the former in energy and space savings, and working environment.

As for conduits, pipeline loss is reduced by parallel operation of existing and newly laid pipelines. Systematic remote control of pumps from a central control center, as well as effective use of nighttime electricity utilizing reservoirs' capacity, contribute to leveling and cutting back on power consumption.

(2) Water treatment facilities

Ozonation facilities make up the largest percentage of electricity consumption for water treatment process. Since 1993, the Hanshin Water has commenced operation of ozonation facilities, with the target residual ozone at 0.2 - 0.3 mg/L.

During initial phases of operations, continuous residual ozone meters were not sufficiently reliable; consequently, operators manually measured the concentration, and they set the ozone dosage after each analysis. Later, the utility itself got involved in creating highly reliable meters, and succeeded in developing automatic continuous measurement and feedback control of residual ozone. As a result, the variation coefficient of residual ozone concentration has improved dramatically, as illustrated in Figure 4 and Table 1, and over 30% reduction has been realized in power consumption per unit water.²⁾

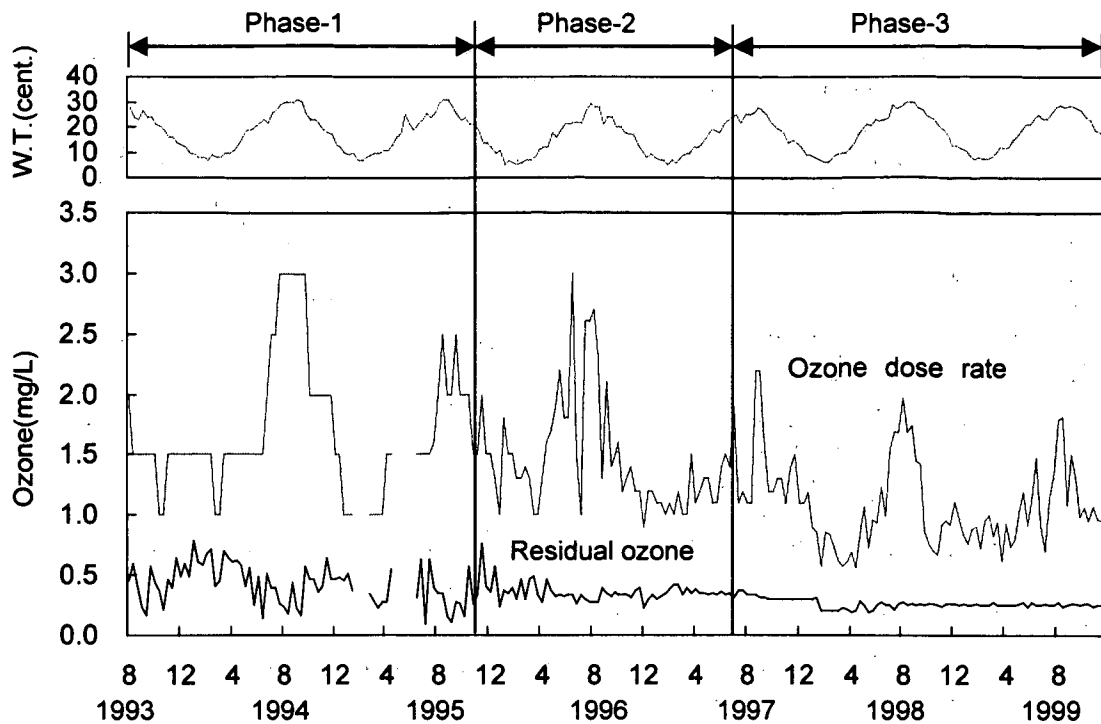

Figure 4 Changes in ozone dosage and residual ozone concentration

Table1 Variation coefficient of residual ozone concentration

	Residual Average	Standard deviation	Coefficient of variation
Phase 1	0.40 (mg/L)	0.177 (mg/L)	45%
Phase 2	0.35 (mg/L)	0.093 (mg/L)	26%
Phase 3	0.25 (mg/L)	0.028 (mg/L)	11%

(3) Change in unit consumption

Figure 5 indicates annual changes in water supply and basic unit. Despite the addition of advanced treatment such as ozonation and activated carbon treatment, unit consumption of electricity has been kept around 0.6 kWh/m³ since 1960, which resulted from such following energy saving measures as pump renewal, effective water transmission, and ozone dosage control.

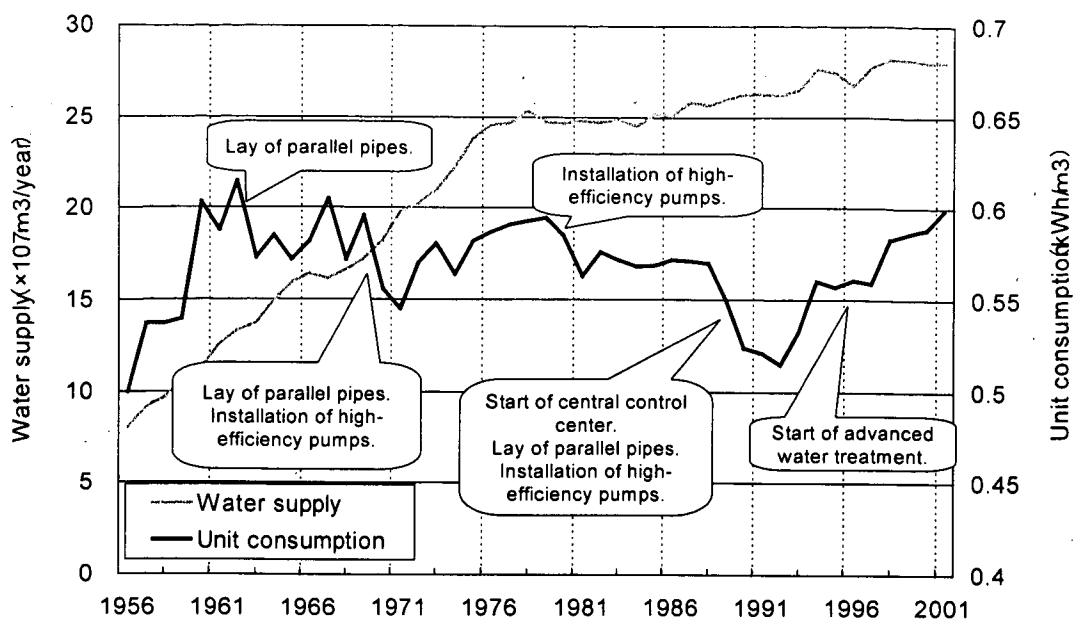

Figure 5 Changes in quantity supplied and basic unit

Table 2 CO₂ discharge reduction in Amagasaki WTP

	Co-generation system	Single generation system	
Electric energy (kWh)	※	5,767,140	
Heat utilization (MJ)	※	13,961,902	
Gas consumption (m ³)	※	158,862	393,804
CO ₂ emissions (kg-CO ₂)	3,415,535	4,820,241	

※ 2001.4 ~ 2002.3 result

CO₂ conversion factor [Natural gas : 2.15 kg-CO₂/m³, Electricity : 0.689 kg-CO₂/kWh (thermal power)]

2-2. Chlorine dioxide discharge reduction

In March of 2001, the Hanshin Water has completed a project reconstructing the Amagasaki WTP, with the aim of introducing cutting-edge treatment technologies and renovating after the Great Hanshin-Awaji Earthquake (“Kobe earthquake” of 1995). It resumed its operation with optimized water treatment technologies coupled with integrated environmental technology.³⁾ A co-generation system (CGS) characterizes its environmental technology, adopted to secure an emergency power and to meet growing thermal demand.

The CGS runs on a gas engine fueled by a natural gas, whose CO₂ discharge is 60% of coal and 75% of petroleum, thereby cutting back on environmental load. This system provides electricity to transmission and distribution pumps both as regular and emergency power. Thermal energy co-generated is used as a heat source inside the WTP to heat sediment sludge, dry dehydrated cake, cool ozonizers, and run air-conditioning equipments. Table 2 and Figure 6 digest CO₂ discharge reduction and an outline of the CGS, respectively. As compared to the case in which CGS is not installed, this system generates less CO₂, by 1,400 tons per year, that is, a reduction rate of about 30%, as shown in Table 2.

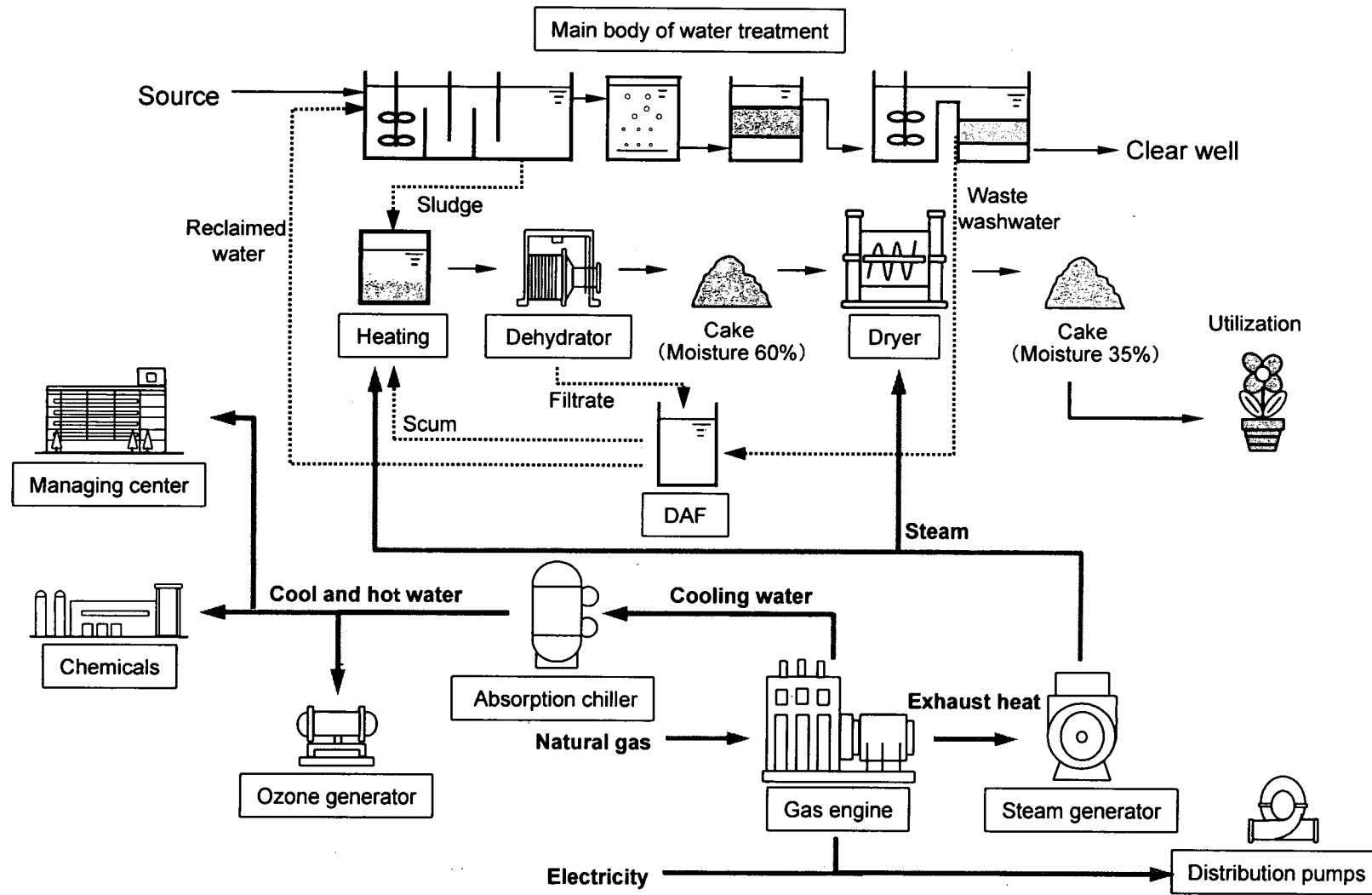

Figure 6 Outline of CGS in Amagasaki WTP

2-3. Recycling of waste materials

Wastewater from each treatment facility is reclaimed as raw water within the plant's closed loop, to follow effluent standards of the Water Pollution Control Law and utilize water resource. Solid materials separated during treatment process mainly derive from sediment sludge and filter backwash water. The majority of sludge is mechanically dehydrated.

At the Amagasaki WTP, exhaust heat from the CGS is utilized for heating sludge before dewatering, to raise the sludge temperature for the purpose of enhancing dehydration efficiency. Plate-shaped cakes from a dehydrator are kneaded and ground up into 0.3 to 5 mm cakes by a pelletizing-drying equipment (drying temperature: 170°C) using steam from the boiler, as shown in Figure 7.

Since the finished cake has an appropriate hardness, as well as extinguishing weed seeds and bacteria by heating, it can be used as alternate material for agricultural and horticultural soils without modification. The sludge is characterized by its high phosphate absorption coefficient and high cation exchange capacity. The former requires additional fertilization, on the other hand, the latter ensures excellent fertilizer retention.

These factors make it possible to add commercial value to the cake and sell it on the spot. Now the utility has achieved 100% utilization or recycling of waste materials at the plant. In addition, spent activated carbon disposed by a constant amount every year has also commercial value as material for agricultural and horticultural soils for its high deodorizing effect.⁴⁾

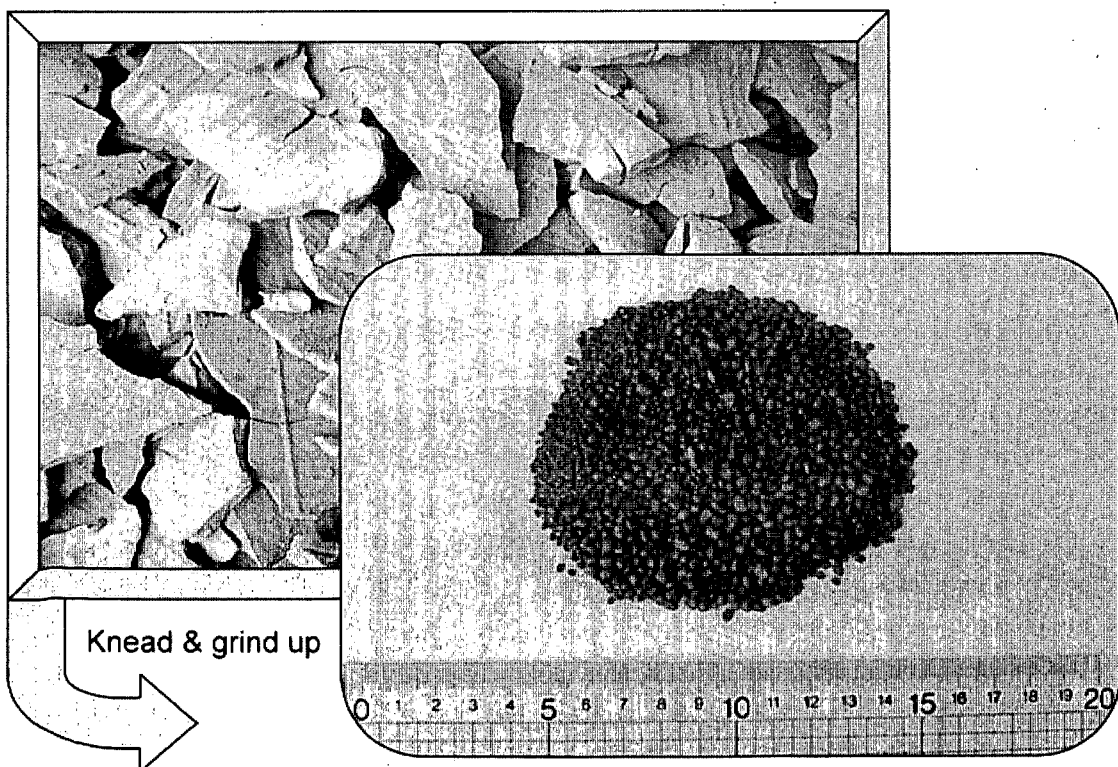

Figure 7 Plate-shaped cakes and palletized cakes

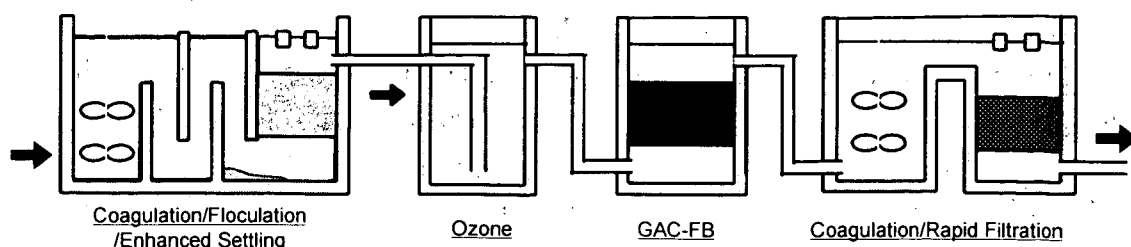

Figure 8 Treatment flow of Amagasaki WTP

2-4. Environmentally-oriented design

Figure 8 shows the main body of treatment flow at the Amagasaki WTP. The basic concept is the Multiple-barrier, which places emphasis upon maintaining a balance between microbial risk and chemical risk of the finished drinking water.⁵⁾ The facilities are marked by the effective use of upward flow and structures in the vertical direction, which are different from the conventional lateral flow and structures. The design concept combines a space-saving design with the idea of viewing gravity as an even resistive body in the vertical motion. As a result, the Plant has a large T_{10}/HRT value [10% mass of tracer outflow time / hydraulic retention time], realizing both facility compactness and treatability enhancement.

Upward-flow sedimentation basin provides an example. As compared to the conventional horizontal-flow type, while the new basin is one-third in volume, the turbidity of its treated water shows a major improvement from 0.6 mg/L to 0.1 mg/L (actual data). The U-tube ozone contactor can raise the T_{10}/HRT value up to 0.7 - 0.8 (estimated) and makes it possible to easily secure a required reaction time. As for the GAC-FB adsorber, the total head loss is only 0.5 to 0.6 m, much less than the conventional downward-flow filtration method, since the carbon bed fluidizes upward.

3. Representative Cases of Other Water Utilities

In Japan, global warming control has become a major challenge. At the same time, energy conservation, which is closely related to the warming, is further growing in importance. In such a situation, laws and regulations have gone into effect concerning the promotion of global warming control and rationalization of energy use. In the preceding chapter, environmental measures taken by the Hanshin Water have been discussed. In the field of water supply, other water utilities are also implementing programs in their way. This chapter presents some examples of environmental protection measures and energy saving carried out by each water utility and corporation. Their websites are helpful to gather information.

3-1. Tokyo Metropolitan Waterworks

Tokyo Metropolitan Waterworks is promoting environmental measures including the management of water source forests and the creation of water-saving lifestyles, as well as efficient energy utilization and the recycling. It manages the forests systematically to maintain a variety of important roles such as water conservation, water quality purification, and CO_2 absorption. Promotion of water-saving lifestyle includes the development of independent

water-saving tap device and effective water use like rainwater.

To promote efficient energy utilization, power generators have been introduced that run on natural gases, solar energy, or elevation head at intake points, and experiments are being conducted on fuel cells-based generators. As for the recycling, the Bureau promotes reuse of materials left in construction works, low-depth installation of pipelines, and the reuse of soil and granular activated carbon from water purification. As a program covering the entire Bureau, an investigation is also under way concerning life cycle assessment (LCA).⁶⁾

3-2. Osaka Prefectural Waterworks

Osaka Prefectural Waterworks is promoting energy conservation, the utilization of natural energy resources, wastes reduction, and recycling. To promote energy conservation and natural resource use, power facilities fueled by natural gases have been introduced, covering 30% of electricity consumed at water treatment plants. At the same time, exhaust heat is utilized to heat dehydrated cake. Power generators are also installed that make use of surplus pressure from transmission pumps and the elevation head at water treatment facilities with hierarchical structure. Moreover, heat exchange between inflow and outflow gas reduces the power consumption by the heater at the exhaust ozone gas decomposer. At sedimentation basins, solar energy panels are mounted on anti-algae shades to utilize natural energy.

To reduce waste material generation and to recycle resources, production is minimized and used as alternate material for athletic field soils. By heating, granular activated carbon is regenerated and reused.⁷⁾

3-3. Kobe City Waterworks

Kobe City Waterworks is implementing measures for the utilization of natural energy resources, as well as energy conservation including efficient pump operation. Natural energy resources, such as solar and hydraulic energy are harnessed to run small-scale power generators used for a telemeter system that controls water distribution management. In case of an accident, the generator serves as an emergency power source.

Making use of the City's topographical characteristics, the Bureau is trying to reduce the unit power consumption for transmission, thorough systematic pumping station renovation and efficient distribution control. Direct water supply that doesn't go through receiving tank is adopted for small-scale two-story buildings to harness water pressure in distribution pipelines, while a direct boosted water supply is employed for buildings with ten floors or so, thereby reducing the power cost borne by consumers.⁸⁾

3-4. Japan Water Works Association (JWWA)

Commissioned by the Ministry of Health and Welfare (MHLW; present Ministry of Health, Labor and Welfare), the JWWA has conducted LCA and other surveys to prepare reports on environmental action plans in the field of water service. The results are compiled in a survey report to formulate guidelines for global warming control.⁹⁾

3-5. Japan Water Research Center (JWRC)

Commissioned by the MHLW, the JWRC has studied measures to promote the reduction and reuse of waste materials. The study includes questionnaire surveys clarifying the current status of waste materials at waterworks facilities and their treatment.¹⁰⁾

4. Future Orientation

Japan's drinking water service is in the process of shifting from expansion to maintenance. Facilities built during the Japan's rapid economic progress now require fundamental renovation. The annual water supply of 17 billion m³ mentioned at the beginning is equivalent to twice as much or more as annual domestic cargo volume of 6.4 billion tons, on the other hand, the power consumption for waterworks is about 8.0 billion kWh/y, only 0.8% of the country's total power consumption of 978.3 billion kWh/y. However, further energy conservation in water service is necessary, considering the fact that the motive cost constitutes a large percentage of the total water supply cost. Meanwhile, wastewater treatment in WTPs annually produces about 360,000 tons of dehydrated cake, only 37% of which is utilized on a national scale. From the standpoint of environmental load reduction, or promoting a recycling-oriented society, greater recycling and reuse are inevitable. Water utilities have limitation to consider global environment within the framework of repair works covered by operating costs. Therefore, it is important to fully grasp each opportunity of facility rehabilitation to integrate environmental technology. Progress should be achieved step-by-step through specific policies, from consideration to guidelines, and then to action plans.

The utilities can afford to ensure accountability for consumers on water treatment technology, which forms the basis of water service, by clarifying the balance of materials including pathogenic microorganisms and disinfection by-products in each treatment process, as well as paying attention to maintain risk balance in finished water. Also with regard to energy consumption and waste materials at treatment plants, it is necessary to introduce environmental technology based on the concept of material balance. Extremely speaking, accomplishing accountability on material balance can lead to the solution of environmental problems.

In this 21st century, more focus will be placed on water-related issues, which include difficulty of restoring natural hydrologic cycle and maintaining global balance in water supply and demand. As stated above, for many people in industrialized countries including Japan, the most familiar water in our daily life is the tap water. By taking a close look at tap water, each consumer is expected to gain a better understanding of the current status of water resources, water treatment technology, water transportation, energy consumption, and waste materials, and then, to take actions against global environmental problems. Water supply and sewerage utilities, constituting part of the hydrologic cycle, have a responsibility to promote information management and action plan for realizing sustainable environment and economy.

Acknowledgement

The Author would like to thank Mr. Toshiaki Hashimoto, Mr. Kenji Komiyama, Mr. Toshiki Suhara, Mr. Masaya Aga, Mr. Yusei Kobayashi, and Mr. Masami Oya for their valuable

assistance in the preparation of this paper.

References

- 1) Editorial Expert Committee of Statistic on Water Supply (2002) Breakdown of yearly analysis by statistic on water supply in 2000. Journal of JWWA, 71(8), 29-67
- 2) Nagashio D., Tsuda H., Kozuki K., and Hanamoto T. (2000) The on-line residual ozone control system for optimizing ozonation. 12th IWA-ASPAC Regional Conference, 491-497
- 3) Sasaki T., Nagashio D, and Hanamoto T. (2000) Renewal with state-of-the-art technology: Amagasaki water treatment plant. 5th International Symposium on Water Supply Technology, 131-139
- 4) Sasaki T., Komiyama K., Suhara T., and Aga M. (2002) Application of energy-saving/zero-emission technologies to the drinking water treatment plant. 17th National Congress for Environmental Studies, 79-86
- 5) Sasaki T., Kobayashi K., Hanamoto T., and Nagashio D. (1999) An optimized water treatment system incorporating protection against *Cryptosporidium* oocysts. IWSA 22nd World Water Congress, SS2, 29-33
- 6) <http://www.waterworks.metro.tokyo.jp/pp/kh13/index.html>
- 7) <http://www.pref.osaka.jp/osaka-pref/suido/kankyo/houkoku10.pdf>
- 8) Oyabu T. and Matsushita M. (2001) New energy application in Kobe City. JWWA Annual Conference, 696-697
- 9) Guideline for global warming control in drinking water supply (1996) JWWA
- 10) Measures to promote the reduction and reuse of waste materials in waterworks (2002) JWRC

**26. Global and Environmental Considerations
Of Wastewater Control In Tokyo**

Presenter

**Mr. Tadashi Takeshima, Tokyo Metropolitan Government
Bureau Of Sewerage**

**GLOBAL AND ENVIRONMENTAL CONSIDERATIONS
OF WASTEWATER CONTROL IN TOKYO**

Tadashi Takeshima

ABSTRACT

Since 1998, each municipality has tackled the global environmental problem in Japan. Tokyo, having an economic scale as large as Canada is also required to take a positive role in sustaining global environment. After sewage works were estimated to occupy 46% of CO₂ emission of all the public works done by Tokyo, Bureau of Sewerage established a long-range plan to cope with the reduction of CO₂ emission associated with sewage works. Above existing menus, an attempt to reduce Nitrous Oxide (N₂O) that has 310 times high potential as that of CO₂ is considered most effective. Monitoring work revealed the incineration temperature increase can reduce most of N₂O from the exhaust gas.

Bureau of Sewerage however, does not limit its effort in technical fields. Certified Environmental Management System according to ISO14001 has produced systematic and effective energy saving activities in everyday works.

INTRODUCTION

Since 1988, when Intergovernmental Panel on Climate Change (IPCC) was established, potential global climate change was widely recognized. The three Working Groups activities have continued to report scientific and socio-economic information relevant for the understanding of the risk of human-induced climate change.

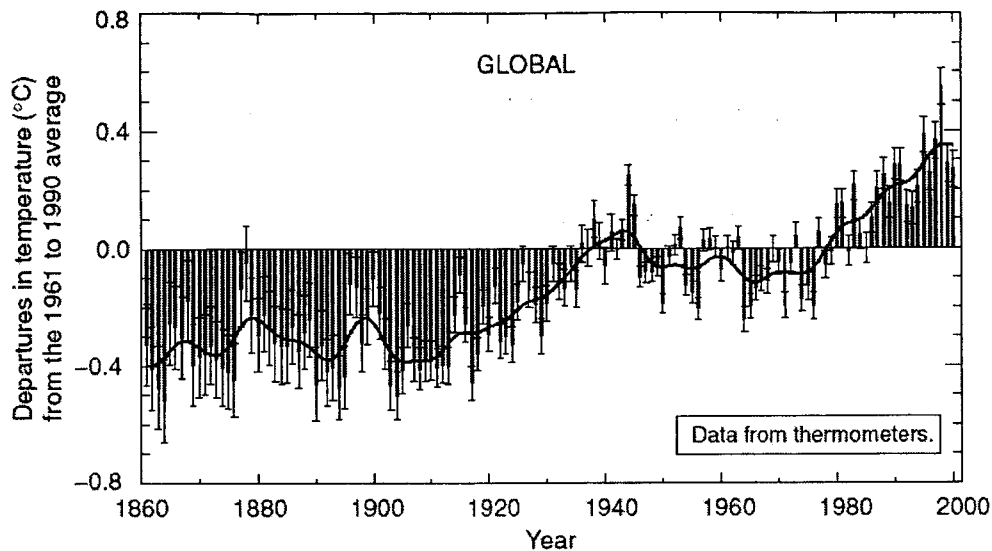

From The Third Assessment Report of IPCC Working Group I

The United Nations Framework Convention on Climate Change (UNFCCC) was adopted in 1992 and provided a framework for action aimed at stabilizing atmospheric concentrations of greenhouse gases at a level that would prevent human-induced actions from leading to “dangerous interference” with the global climate system. Seven meetings of the Conference of Parties (COP) have taken place as well as numerous workshops thereafter.

After intense negotiations at COP3 held in Kyoto, Japan in December 1997, delegates agreed to a Protocol to the UNFCCC that commits developed countries and

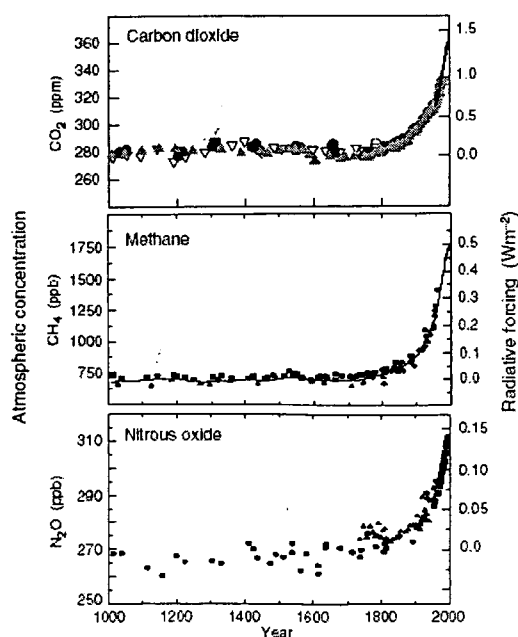

From The Third Assessment Report of IPCC Working Group I

countries making the transition to a market economy to achieve quantified targets for decreasing their emissions of greenhouse gases. These countries, known under the UNFCCC as Annex I Parties, committed themselves to reducing their overall emissions of six greenhouse gases (by at least 5% (6% to Japan) below 1990 levels over the period between 2008 and 2012, with specific targets varying from country to country.

The six greenhouse effect gases are

Carbon Dioxide(CO₂), Methane(CH₄), Nitrous Oxide(N₂O), Hydrofluorocarbons (HFCs), Perfluorocarbons(PFCs) and Sulphur hexafluoride (SF₆).

In response to those international activities, a new legislation named “Promoting Prevention Measures Against Earth Temperature Increase” was established in 1998. In the article four, it prescribes local municipalities must promote measures controlling emission of those greenhouse effect gases in each region. Local municipalities also have to establish an action plan to reduce the emission from their public works.

In regard to wastewater control in Japan, it is said approximately 0.6% of total electric power is used for sewage works. Japan Sewage Works Association (JSWA) based on the request by the Ministry of Construction, now the Ministry of Land, Infrastructure and Transport (MLIT) published in 1999, a guiding ¹⁾ to promote new technology and energy savings to control greenhouse effect gas emissions from sewage works.

STATUS OF GLOBAL CONSIDERATIONS FOR PUBLIC WORKS IN JAPAN

Each municipality, based on the legislation of 1998, extended its global concept toward guiding private businesses to reduce greenhouse gas emission.

In Tokyo, “Ordinance on Environmental Preservation” was totally revised in 2001. It requires businesses that consume a large amount of energy to submit a “Counter Plan Against Global Warming” to the governor. In the plan, each business has to estimate how much greenhouse effect gas is emitted. The results of the plan should be opened to the public. As for HFCs used for such as refrigerators, it bans to emit them to atmosphere. As for controlling energy consumption by large buildings, it requires when building a large scale one with a total floor area over 10,000m², to submit a Building Environmental Plan that should state how much the environment-friendly measures are taken.

As Tokyo is one of the biggest cities that have economic scales larger than Canada, it requires positive role to promote reducing greenhouse gases. **Table.1** shows the consumed energy in Tokyo indicates a relatively low as around 6% of whole Japan, nevertheless its population covers 10% of the total. In other words, energy for Tokyo is consumed considerably in other places in the course of making products for it. For the time being, the targets to guide are business and transportation as well as domestic.

Table.1 Energy consumption of Tokyo in 1998 (Unit PJ or 10¹⁵J)

	Tokyo		Whole Japan	
	Value	Percentage	Value	Percentage
Industry	90	10%	7,021	46%
Domestic	166	19%	2,100	14%
Business	254	29%	1,897	13%
Transportation	357	41%	3,818	25%
Others	-	-	319	2%
Total	867	100%	15,155	100%

Table.2 CO₂ emission from public works of Tokyo in 1999 (Unit ton)

	CO ₂	N ₂ O	CH ₄	Others	Total	Percentages
Bureau of Sewerage	436,826	353,112	25,037	12,989	827,965	46.3
Bureau of Waterworks	311,087	145	637	1,615	313,486	17.5
Bureau of Transportation	217,308	544	47	1,938	219,838	12.3
Metropolitan Police Department	97,447	278	175	484	98,385	5.5
Bureau of Public Health	87,558	2,953	377	22	90,911	5.1
Others	236,390	682	808	1,284	239,159	13.3
Total	1,386,616	357,714	27,081	18,332	1,789,744	100

For the public works by the Tokyo Metropolitan Government (TMG) itself, it drew up a new plan called "Tokyo Metropolitan Plan to Preserve Earth". It requires greenhouse effect gas emission should be cut 2% of 1999 in year 2004.

Table 2 shows the estimation of greenhouse effect gas emissions for whole public works of Tokyo in 1990. It is clear that emission from the sewage works occupies as much as 46.3%, the largest amount among the total public works.

GLOBAL CONSIDERATIONS FOR WASTEWATER CONTROL IN TOKYO

Bureau of Sewerage recognizes its important role to reduce greenhouse effect gases and therefore newly established a long range plan "Sewerage Works Plan 2001"(Plan2001) which aims the amount of greenhouse effect gas emission in 2004 to be reduced by 30,000 CO₂ton or 3% of the year 1999.

In **Table 3** the total CO₂ emission by the sewage works in 1999 is listed in every item. Each CO₂ emission value was calculated mostly by the Guiding of JSWA 1999. The result shows the total CO₂ emission reached 823,000 tons, while 372,000 tons(45%) was occupied by wastewater treatment process, 428,000 tons(52%) by sludge treatment. It also indicates reuse of sewage resource such as heat recovery from sewage balances 11,000 tons(1.4%) of the total emission.

The concept of the Plan2001 focused for the time being however, on the amount of CO₂ reduction compared to the case no considerations have been taken. In other words, it does not promise to reduce the absolute amount of CO₂ emission. It is because the sewage works in Tokyo are still on the way to improve water environment. The future CO₂ increase is estimated in many fields such as incinerated sludge ratio from 93% in 1999 to 100% in 2004. It is because recycling of sludge is based on sludge ash and the landfill site is limited. Moreover, advanced wastewater treatment process needs much energy.

The plan established to attain reduction of 30,000 tons of CO₂ by the following four basic targets. In year 2000, the Bureau succeeded to attain 14,000 tons of CO₂ reduction compared to the previous year.

1. Increase incineration temperature to reduce Nitrous Oxide gas emission
2. Convert fuel source from heavy or light oil to city gas to lower CO₂ emission
3. Promote heat recovery from sewage
4. Improve energy saving by efficient operations

Table 3 State of CO2 emission in sewage works of Tokyo 1999

		Amount in 1999	CO ₂ (ton)	CH ₄ (kg)	N ₂ O (kg)	CO ₂ Emission (ton)
Wastewater Treatment	① Emission by Energy Use					
	Electric for Wastewater Treatment (kWh)	484,472,871	186,038			186,038
	Electric for Pumping Stations (kWh)	77,819,569	29,883			29,883
	Electric Pumping Reclaimed Water (kWh)	5,312,204	2,040			2,040
	Heavy Oil for Wastewater Treatment (kl)	884	2,385			2,385
	Kerosene for Wastewater Treatment (kl)	1,312	3,317			3,317
	Light Oil (kl)	2	5			5
	Propane (m ³)	16,630	98			98
	Automobile gasoline (kl)	141	333	292	26	347
	Automobile light oil (kl)	21	56	1	3	57
					Subtotal	224,170
	② Emission by Treatment Process					
	Amount of Biologically Treated wastewater (m ³)	1,762,217,820		2,199,317	329,352	148,285
	Subtotal					372,455
Sludge Treatment	① Emission by Energy Use					
	Electric for Sludge Treatment (kWh)	121,411,020	46,622			46,622
	Electric for the two Sludge Treatment Plants (kWh)	82,189,868	31,561			31,561
	Electric for sludge cake mixing plant before landfill (kWh)	966,570	371			371
	Heavy Oil Incinerators (kl)	9,262	24,986			24,986
	Kerosene Incinerators (kl)	2,966	7,499			7,499
	City gas (1000m ³)	17,265	34,382			34,382
					Subtotal	145,421
	② Emission by Treatment Process					
	Incinerated Sludge Cake (ton)	995,818		35,800	911,173	283,215
	Subtotal					428,636
Chemicals Etc.	③ Emission by Chemical Use and Etc.					
	City Water (m ³)	544,337	1,095			1,095
	Industrial Water (m ³)	49,100	5			5
	Sodium Hypochlorite (ton)	14,333	4,601			4,601
	Polymer (ton)	926	6,050			6,050
	Lime (ton)	15,531	6,942			6,942
	Ferric chloride (ton)	11,064	3,518			3,518
	Caustic soda (ton)	6,601	6,192			6,192
	Cement for sludge cake land filling (ton)	5,939	4,496			4,496
Others (ton)		991			991	
					Subtotal	33,890
Recovery by Reuse	④ Amount of Reduction by Utilization					
	Heat recovery from wastewater (kwh)	18,851,792	-7239			-7239
	Melted sludge slag (1,000 ton)	1	-7			-7
	Sludge Ash Bricks (¥10,000)	4,515	-1386			-1386
	Reclaimed Water (m ³)	26,653,502	-2879			-2879
					Subtotal	-11511
Total						823,470

STATUS OF RECENT DEVELOPMENT FOR CONTROLLING GREEN HOUSE EFFECT GASES IN WASTEWATER TREATMENT PROCESSES

The first target to reduce CO₂ emission was thought to be the emission of Nitrous Oxide from sludge incinerators' exhaust gas as it has been estimated to cover 34% of the total emission according the guiding of JSWA 1999.

Followings are from the extract of research works using existing full-scale facilities.

(1) Temperature effect on N₂O emission from sludge incinerators

Method

Infrared analyzer was used to monitor Nitrous Oxide from sludge incinerators' exhaust gas continuously. Monitored incinerators are multi-stage types and fluidized bed ones. Types of sludge cake for the former are lime and polymer and polymer for the latter. Length of monitoring ranged from 6 to 14 days depending to each case.

Results

Table 4 shows the variations of the N₂O emission coefficients between two types of incinerators along with types of sludge. The two fluidized-bed types, new and existing one incinerates polymer sludge. The difference is the temperature adopted. The new one is afford to higher temperature incineration. The result shows different value from the guiding 1999 might be obtained depending on the conditions. The variations of the N₂O in exhaust gas are also confirmed as shown in **Fig.1**.

Table 4 N₂O Emission coefficients of sludge incinerators

Type of Incinerator	Days	Average Temperature (°C)	Emission Coefficient (kg-N ₂ O/ton-DS)	Emission Coefficient (1999)
Multi-stage (Lime)	11	754	3.53	1.32
Multi-stage (Polymer)	8	690	2.51	3.00
Fluidized-bed (Existing)	6	828	4.76	5.20
Fluidized-bed (New type)	14	838	2.74	

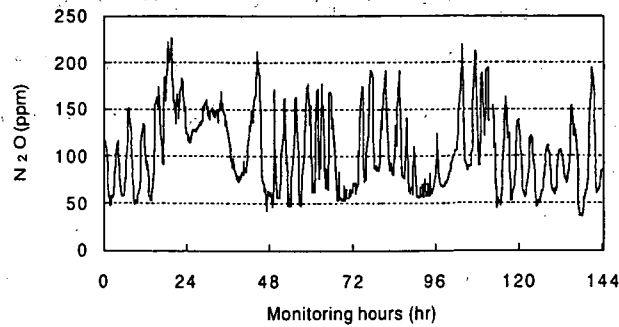

Fig. 1 Nitrous Oxide in exhaust gas from Sludge Incinerator

However, for the fluidized-bed that is adopted to most of the large-scale sludge incinerators today, it is clear from Fig.2 that higher temperature can reduce N_2O emission remarkably. The figure shows increase of temperature from 820 to 840 can reduce 50% of N_2O emission from exhaust gas. The effectiveness of temperature increase covers the increase of CO_2 associated with the fuel to attain higher temperature.

The temperature increase however should not be adopted easily because of safety operation of incinerators. Bureau of Sewerage is going to adopt the higher temperature incineration to the construction of new ones.

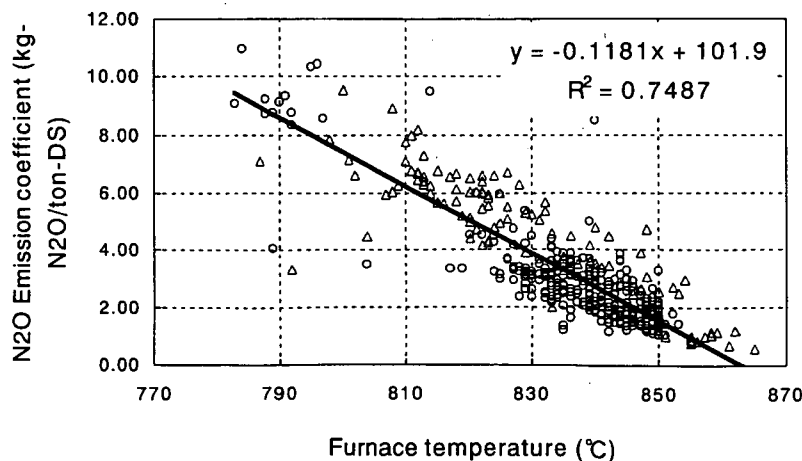

Fig. 2 Furnace temperature and N_2O emission coefficient in fluidized bed incinerators

(2) Installing a new type of battery system to utilize lower emission electricity

As is well known in electricity, percent of consumed fossil fuel is lower at night-time (254 g-CO₂/kWh) than in day-time (354 g-CO₂/kWh) as well as in the costs. In 2001, Bureau of Sewerage adopted a full scale NaS battery system to utilize lower emission electricity to a wastewater treatment plant. The new battery, Sodium-Sulfur system has high potential of electric charge efficiency (79%) that 1,000 kW capacity is estimated to reduce CO₂ emission by 86 ton per year besides attaining electric cost saving as much as 25 million yen per year.

SCOPE AND POLICY TO REACH THE GOAL

Reevaluate emission coefficients for wastewater treatment process

There are however many problems left to reach the goal. One is the lack of actual greenhouse gas emission data that should be the key factor to estimate efficient strategy. The research work as mentioned confirmed incinerator development could reduce most of N₂O emission from sludge treatment process. However, for gas emission from biological process, large-scale variation of N₂O emission was monitored as in Fig.3 for an example.

Further research showed those variations were caused by those of daily loadings and the influence of stormwater to the treatment plant. New classification as a result is proposed for estimating emission coefficient for wastewater treatment process.

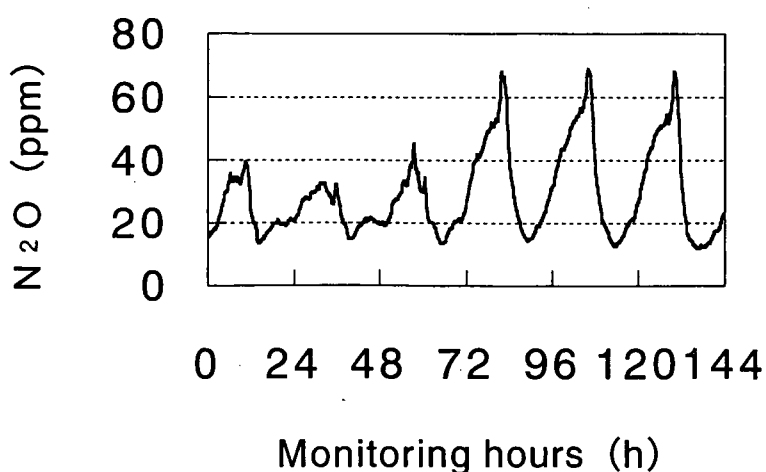

Fig.3 Nitrous Oxide in off-gas from bioreactor

Table 5 proposes a modification of the guiding of JSWA 1999 to estimate more precise N₂O emission for wastewater treatment process.

So, further planning should be recalculated on these new classification instead of that of the guiding of JSWA 1999.

In common sense, it is natural to assume promotion of better effluent quality and energy savings belong to a trade-off relation. Advanced wastewater treatment process that removes nitrogen by nitrification-denitrification consumes energy of 1.3 times as much as the conventional activated sludge process. However, it can also reduce nitrous oxide gas emission as listed in the Table 5.

Table 5 A new classification of N₂O emission by degree of nitrification

Classification	Effluent nitrogen (mg/l)			Number of data	Emission coefficient ^{*)}	JSWA 1999
	NH ₄ -N	NO ₂ -N	NO ₃ -N			
Nitrate-type	Other than below			177	0.061	0.011
Nitrite-type 1	—	> 1, ≤ 2	—	34	0.261	0.33
Nitrite-type 2	—	> 2	—	14	0.610	
Nitrification-Denitrification	≤ 1	≤ 1	≤ 5	14	0.014	0.012
Un-nitrified	> 10	≤ 1	—	38	0.023	0.16

*Unit of emission co-efficient = g-N₂O/m³-wastewater

An example of estimation based on the new emission co-efficient is shown in Table 6 that indicates advancement of treatment level does not necessarily increase greenhouse effect gas emission. In 1999, the amount of advanced treatment in Tokyo stays around 7.6% of the total treated wastewater. However, the calculation shows the increase of advanced treatment would reduce process emission of greenhouse gas far more than the amount of the associated energy increase.

Table 6 Effect of Advanced Treatment on Greenhouse Gas Emission

		Ratio of Advanced Treatment			
		(1999) 7.6%	10%	15%	20%
Treatment	Wastewater Treatment	100,527	98,661	94,772	90,882
Process	Sludge Treatment	283,215	283,215	283,215	283,215
Energy Use		369,591	370,900	373,629	376,357
Chemicals Etc.		33,890	33,890	33,890	33,890
Recovery by Reuse		-11,511	-11,511	-11,511	-11,511
Total CO ₂ Emission		775,712 100%	775,155 99.9%	773,995 99.8%	772,834 99.6%

*Unit: ton-CO₂/year

Environmental management approach

Those mentioned approach that focuses mainly on the target (Nitrous Oxide) might not achieve the final goal. More systematic and overall management system is really needed to establish energy savings in sewage works.

One solution is the environmental management system (EMS) ISO14001. From 1999 Bureau Sewage started building EMS to each treatment plant and is going to obtain certification for all the organization under the total EMS.

The purpose of the EMS cannot be restricted to the upgrading energy performance of public works to attain the planned value. It also aims to establish public works of more communicative nature to the residents, more sensitive to the environmental change and technological development.

Being a relatively small activity as compared with the global scale, it may contribute a lot more than assumed if everyone understands the seriousness of global climate change. The Bureau of Sewerage will continue to improve both treatment level and greenhouse gas emission to serve people in better environment.

Reference

- 1):“Guiding of making action plan for controlling greenhouse effect gas emission from sewage works (Japanese),” Japan Sewage Works Association Aug. 1999

**27. Global and Environmental Considerations in Drinking
Water Supply and Wastewater Control
(Climate Impact / Energy Savings)**

Presenter

Dr. James Goodrich, USEPA

Global and Environmental Consideration in Drinking Water Supply and Wastewater Control

By

Dr. James A. Goodrich and Trent G. Schade

Water Quality Management Branch, Water Supply & Water Resources Division, National Risk Management Research Laboratory, Office of Research and Development, USEPA

EPA Research Strategy

Global Change Research Program (GCRP), 2000

Climate Change Research Initiative (CCRI), 2001

GCRP Holistic Approach

Assessment of the consequences of global change on:

- Air Quality
- Water Quality
- Human Health
- Ecosystem Health

Strategic Principles

Focus on:

- Future stresses and the dynamics of change
- Both risks and opportunities
- Multiple stresses
- Human dimensions considerations
- Assessment of adaptation options
- Appropriate geographic scale

U.S. Climate Change Research Initiative (CCRI)

Supplement to the Global Change Research Program (GCRP) following analysis by the National Academy of Sciences:

Comprehensive inventory of climate and global change research programs sponsored by Federal Agencies

- Criteria to prioritize current and proposed research
- Identification of gaps and overlaps in current programs
- Interagency prioritization
- Publication of joint CCRI/GCRP implementation plan

CCRI (Cont.)

Key Products:

- A series of nationwide studies conducted during the next five years that explore the effects of –
 - Climate change on ambient air quality in major metropolitan areas
 - Changes in air quality on human health
 - Waste water treatment costs may be affected by climate change and changes in extreme precipitation events
 - Climate change and climate variability on drinking water quality
 - Climate change on water-borne diseases in metropolitan areas
 - Climate variability on weather-related morbidity

CCRI (Cont.)

- Decision-support tools
 - Appropriate response strategies for public health officials
 - Evaluate responses at the societal/individual level (public health system)
- Regional Research
 - Determine the quantitative effect of climate change on tropospheric ozone and particulate matter
 - Identify geographic areas that will experience the largest changes (positive and negative)

➤ Regional Research (Cont.)

- Access the consequences of climate change on:
 - ❖ Drinking water infrastructure
 - ❖ Waste water treatment
 - ❖ Surface water quality
 - ❖ Surface water/groundwater interaction
- Examine the potential for adaptive responses to protecting drinking water and surface waters for human and ecosystem uses in urban areas

Drinking Water and Wastewater Utility Adaptation to Climate and Land Use Change

NRMRL/WSWRD/Cincinnati

NRMRL's Role

- Provide input on how global change (climate, land use) and technology change influence (good and bad) environmental stressors such as,
 - changes in flow, nutrients, sediments, pathogens, toxics, etc. and their impacts on water quality and aquatic habitat
 - determine utility vulnerability relative to watershed characteristics and system capabilities at the local level
- Quantify the upgrades needed by the utility in terms of Q&M, new technology, and/or non-structural alternatives

Watershed Approach:

- Integrate drinking water and wastewater adaptations
 - Identify watershed physical characteristics
 - timing, depth, and duration of wet/dry conditions
 - central vs. decentralized drinking water and wastewater systems
 - smart growth
 - spatial optimization of Best Management Practices

Employing Land-Use Schemes as a Mitigation Strategy for the Water Quality Impacts of Climate change

Little Miami River Watershed Case Study:

- Current and future land use development plans to simulate water quality changes
- Climate change scenarios overlay land use schemes
 - + or - 20% change in precipitation
 - + 2 to 4 degree Celsius change in air temperature
 - Eight combinations plus no change simulated

How will global change impact local aquatic ecosystems?

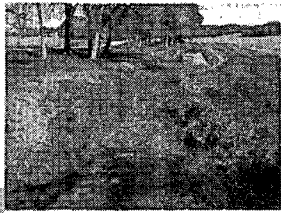
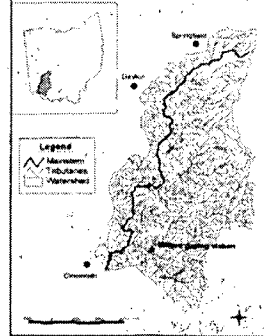

Figure 1.2. Little Miami River Watershed



Land-use data provides current local distributed parameters.

QUAL2E Simulation Schematic

A simple fate and transport model like QUAL2E shows how systems respond to pollution input...

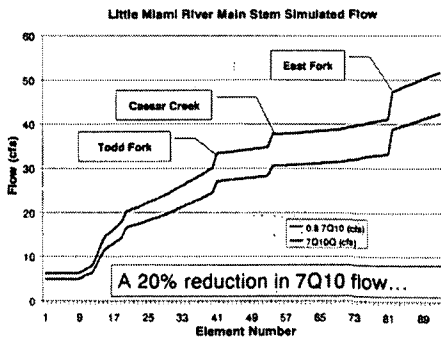
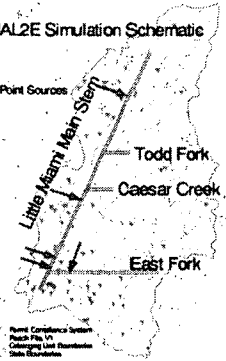

...has potential consequences on infrastructure permits, aquatic habitat, and beneficial uses.

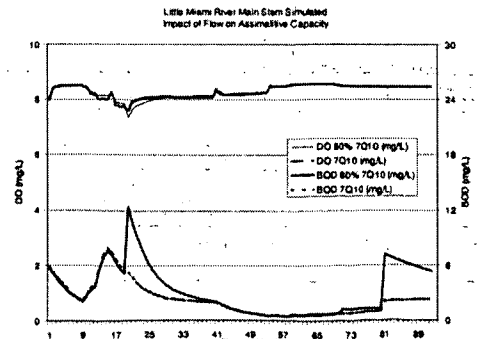

GIS Laboratory

- Image Analysis
- Spatial Databases
- Scanning
- Plotting
- Printing
- Digitizing

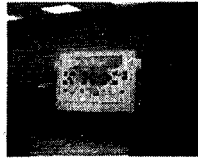

Provenance of Pb in Kankakee Watershed, Indiana

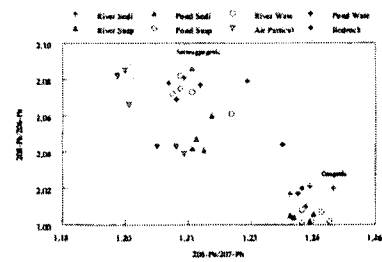

Results

- Most significant climate change scenarios:
 - Wettest was + 2 degree celsius increase with + 20% increase in precipitation
 - Driest was + 4 degrees celsius with - 29% decrease in precipitation
- Changes in nutrient, runoff, and sediment loads significant in both
- Land use changes can be more significant than climate change
 - Agricultural land use change to suburban actually decreased sediment load

Drinking Water and Wastewater Treatment Infrastructure Adaptation

Cost Analysis Techniques:

- Planning and siting
- Design
- Operation

Table 1. Cost analysis techniques

Paradigm	Cost Method	Description
Planning and Siting	Life Cycle Analysis	The expected project life cycle expands or contracts under uncertainty of climate adding or subtracting from the project cost.
Design	Capital Cost of Alternatives	The cost of a design made under existing conditions is compared to a design made under assumptions of altered climate.
Operation	Historical O & M Costs	Frequency analysis of historical O&M costs analyzed according to expected changes in climate.

Figure 1. Schematic of the System

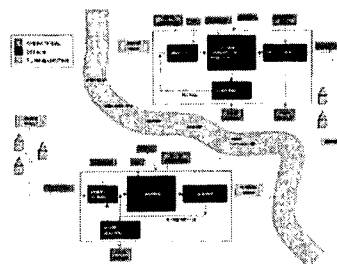

Figure 2. Reverse Design to

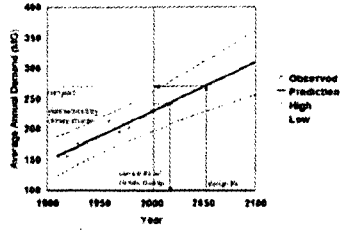

Figure 3. Water Year Treatment Plant Capacity Flexibility

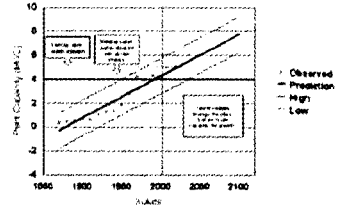
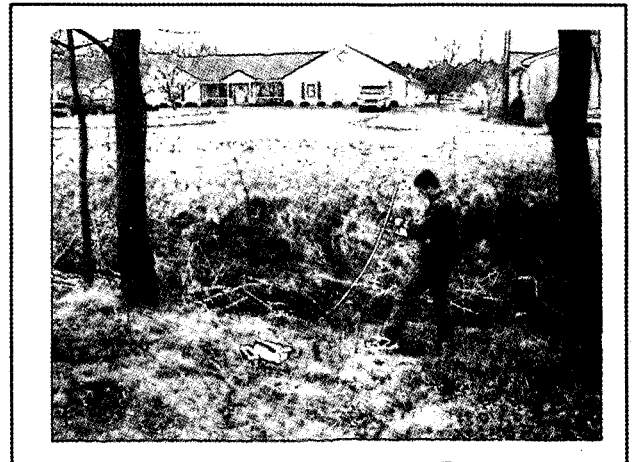
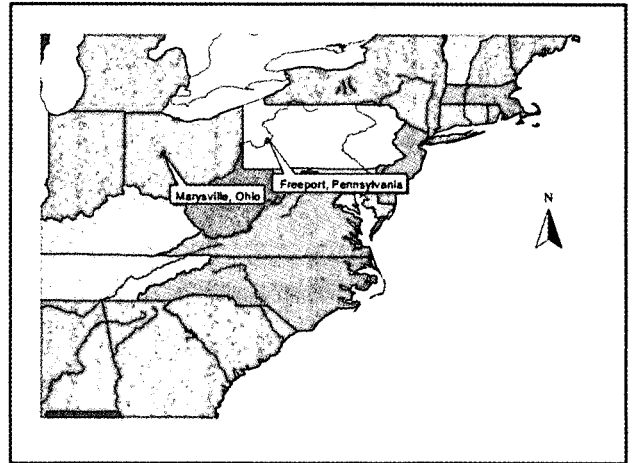
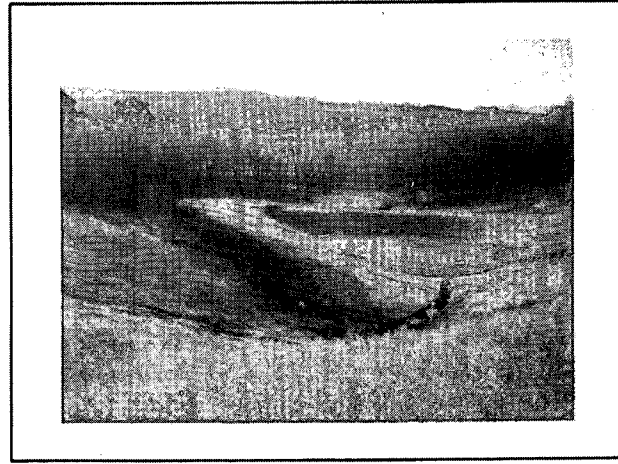
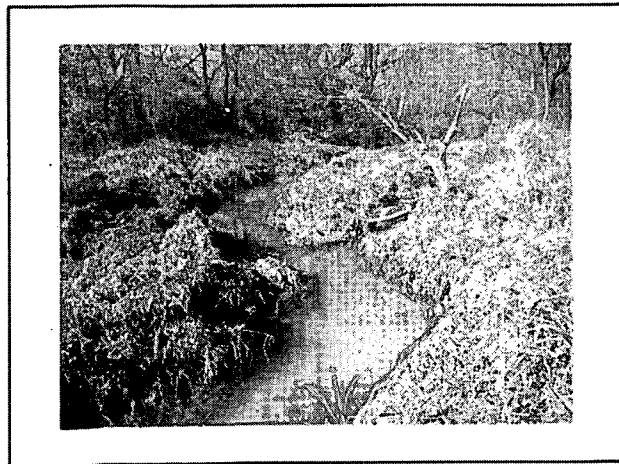
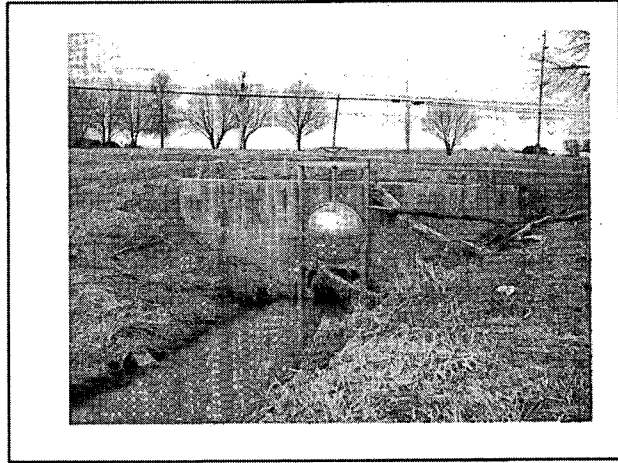
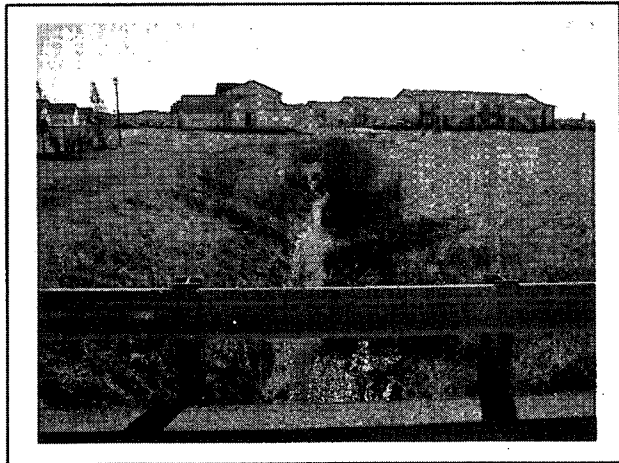
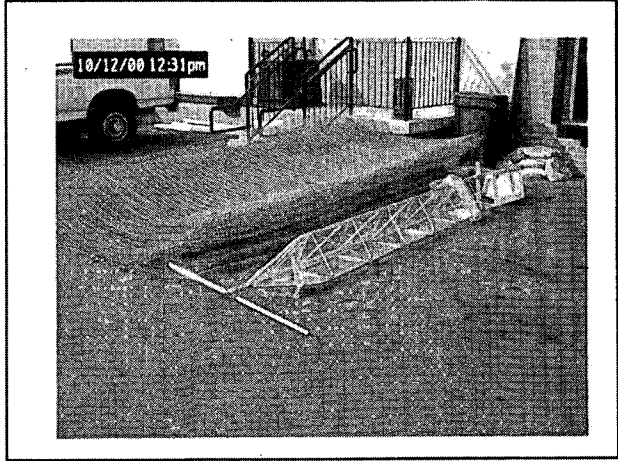
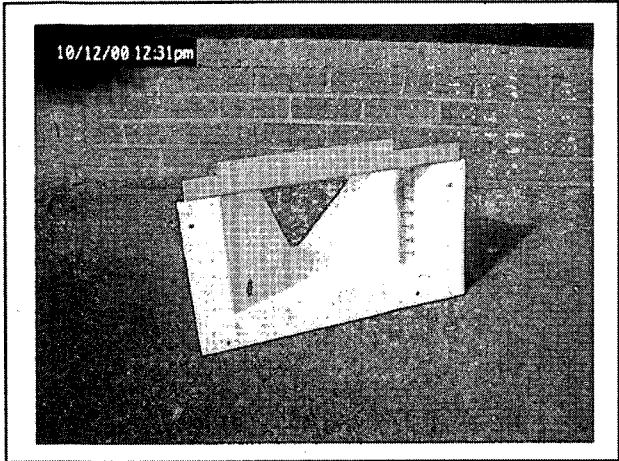

Table 3. Sensitivity of Cost of Optimized Treatment Design to Flow and Suspended Solids from (Muhlenberg Basin et al., 1993)

Parameter	Change in parameter over base value (%)	Change in total annualized cost (%)
Flow	+20	+13.60
	+10	+7.82
	-10	-5.06
	-20	-13.40
Suspended Solids Concentration	+20	+1.55
	+10	Nil
	-10	-1.83
	-20	-1.83





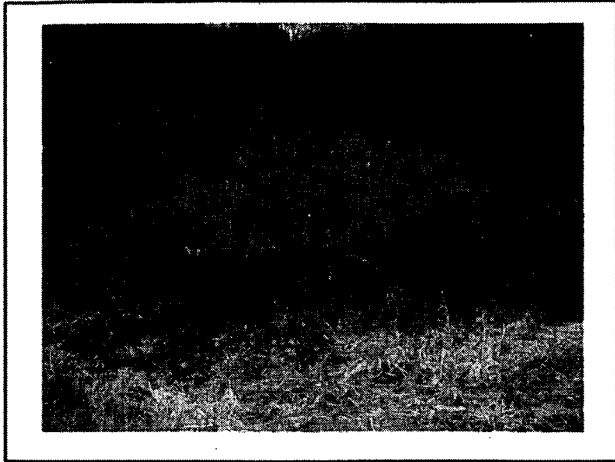

Table 3. Infrastructure Adaptation Costs

Infrastructure	Vulnerability	Adaptation	Example Costs
Drinking Water			
Planning and engineering for supply reservoir	Vulnerability to changes in flow & timing	Storage for peak	Including climate change, other planning increases flow, reservoir cost by 10%
Designing a peak flow drinking water treatment plant	Changes in water quality	More design or construction	Cost of construction is up to 10 percent higher because of flow
Operating a drinking water treatment plant	Changes in water quality	More O&M budgeting to higher production	Extra budget, chemical cost during low production years
Waste Water			
Planning and engineering for treatment plant structures	Changes in flow & timing water quality	Storage for peak	Including climate change, other planning increases flow, reservoir cost by 10%
Designing an advanced design, sewage treatment plant to meet	Changes in flow & timing water quality	Design with more redundancy and processes	Cost of construction is up to 10 percent higher for O&M during
Operating an advanced design treatment plant	Changes in flow & timing water quality	More O&M budgeting to higher production	Extra budget, chemical cost during low production years. More budget in peak seasons

28. PRIVATIZATION OF WATER UTILITIES IN JAPAN

Presenter

Mr. Shozo YAMAZAKI, Japan Water Works Association

PRIVATIZATION OF WATER UTILITIES IN JAPAN

By

Shozo YAMAZAKI

Individual Member, Japan Water Works Association

ABSTRACT

While the global trend of privatization in the water industry and the recent revision of the Water Works Law in Japan have certainly cast a new light on the privatization of water utilities in the country, it is also true that most Japanese are still seeing this to be the mere expansion of outsourcing by water utilities. This paper outlines the characteristics of water utilities in Japan, the past and on-going initiatives towards privatization in the country and introduces various views and opinions revolving around privatization, including my own views on how public water utilities could possibly be privatized in the future.

1. INTRODUCTION – Environments Surrounding Water Utilities in Japan

In 1980s three mega public agencies, Japan National Railways, Nippon Telephone and Telegraph Public Corporation, and Japan Tobacco Monopoly, were corporatized as part of the government's deregulation policy and, more importantly, to strengthen their financial capabilities. Most of these attempts appear to have been successful.

In 1990s the privatization of government agencies and government-affiliated corporations was further accelerated due to the country's sluggish business environments resulted from the collapse of so-called "bubble economy".

It is a widely accepted view that a public corporation, more or less, has a reclusive character and inefficiencies in its management. With the revision of the Water Works Law enforced in this April and the global trend of privatization in the water industry, this is probably the right time for water utilities in Japan to discuss privatization more seriously.

In Japan, water utilities, have been managed by local governments since their establishment. In the beginning, water utilities were created with a public mission to prevent the spread of epidemic diseases, in particular, cholera. It was because of this public mission that the public management of water utilities was considered to be the most logical consequence. And, since the operation of water services has a region-dominant nature, local governments such as cities, towns and villages were considered to be the most appropriate entities to run water utilities.

Clause 2 of the Waterworks Ordinance issued in 1890 stipulated that piped water supply

systems should be constructed with “public funds”. This literally meant that water utilities should be managed exclusively by “public sectors”. The Ordinance was amended twice in 1911 and 1913, which, for the first time in history, allowed private companies to enter into the business of water services under certain special circumstances. Meanwhile, the general principle of public-management has been persisted until today in that only a few water utilities are currently being mostly/fully managed by private sectors. For instance, water utilities owned by Iida City in Nagano Prefecture and Miharu Town in Fukushima Prefecture are outsourcing most of their work and some small-scale water supply systems developed in resort towns and villages are fully operated by private companies. They are nevertheless still small in number, i.e. only ten or so of approximately 11,000 water utilities currently being operated in Japan. In reality, however, many water utilities are outsourcing part of their work to private companies in one way or another, since the operations and maintenance of water supply systems, regardless of its size, require a massive input of human and financial resources. One of the outstanding characteristics of water utilities in Japan is the large number of small-scale water utilities. Table-1 and Table-2 show the Number of Water Utilities by Type and the Number of Water Utilities/Volume of Water Supplied by Scale, respectively.

Table-1 Number of Water Utilities by Type (as of March 31, 2001)

	Bulk Water Supply	Public Water Supply	Small Public Water Supply	Total
Number	111	1958	8979	11048

↑ Note: including 15 of under construction

Table-2 Number of Water Utilities/Volume of Water Supplied by Scale

(as of March 31, 2001)

Type	Category by Scale of Population Served	Number	Cummulative Population Served (10 thou.)	Annual Volume Supplied (Bn. cu.m)
Public Water Supply	> 1.0 million	13	3463	4.86
	0.5-1.0	9	616	0.83
	0.25-0.5	51	1762	2.41
	0.1-0.25	132	1985	2.73
	0.05-0.1	185	1270	1.77
	Sub-total	390	(3.6%)	
	30-50 thou.	219	839	1.17
	20-30	208	503	0.69
	10-20	503	709	1.01
	5-10	483	354	0.51
	< 5	140	52	0.1
	Sub-total	1553	(14.2%)	
Total	1943	11553	16.08	
Small Public Water Supply		8979	643	0.85
Grand-total		10922	(100%) 12196	16.93

Note: Number of Small Municipalities (Town and Village) = 2,543 (as of April 1, 2002)

Small-scale water utilities with a total population served of less than 50,000 account for 96.4 percent. These small-scale water utilities are owned by municipalities and are, in most cases, facing difficulties such as increasing management costs and manpower shortages, which can be solved by regionalization, wide-area services by integration.

A prolonged depression in Japan and the resulting income shortfalls at both local and national governments had eventually led to the enforcement of the PFI (Private Finance Initiative) Promotion Act in September 1999. The Act allows private sectors to finance, operate and maintain part of public utility schemes, including business administration.

Emerging water quality issues such as trihalomethanes, cryptosporidium and endocrine disrupters have required water utilities to strengthen their capacity to invariably meet the reinforced water quality standards. It is however becoming increasingly difficult for most small-scale water utilities to comply with this requirement due to their limited human and financial resources.

Against this background, the Water Works Law was amended and enforced in April 2002 with a view to enabling public water utilities to entrust their entire technical operation to third parties and to facilitating water utilities merging with their neighbors. Although this amendment does not directly target at the enhancement of privatization, it has, along with the current trend of deregulation, certainly paved the way for privatization of water services in Japan in the future.

2. PRESENT SITUATION OF PRIVATIZATION IN THE WORLD

There are several different types of privatization actually in place in the world. Historically, the privatization of water services was initiated in some western countries. They are chronologically France, the United Kingdom (England/Wales) and the United States of America.. Each of these countries, however, has a different background of privatization.

In France, Generale des Eaux (present Vivendi) was the first contractor entrusted the management of a water supply by Lyon City in 1853. Since then, such a management style has spread over the whole country, and nowadays, privatized water utilities supply nearly 90 percent of the population with tap water. Although several different types of privatization such as management contract, leasing and concession are in practice in France, they are basically a public-asset-ownership and private-management system. It is said that once there were about 50 such private companies, but now only three companies, Vivendi, Ondeo (a subsidiary of Suez Lyonnaise des Eaux) and Saur, account for about 70 percent of the market.

In the United Kingdom, roughly 300 local public water utilities in England and Wales were integrated into 10 state-owned-enterprises (water authorities) along each river system in 1973. Afterward, as part of the privatization policy set up in 1989 by the then Prime Minister Margaret Thatcher, they were privatized. Today, ten private water supply companies including main three companies, Thames Water (a subsidiary of RWE), Severn Trent and Anglian Water, account for about 75 percent of the population. The type of privatization is called either “full privatization” or “totally private ownership” and involves the securitization of assets and listing of stocks in the stock market.

In the United States, there are three management types such as public, partially privatized and fully privatized utilities. Many small/medium-scale water utilities have been affiliated with large water companies such as Azurix, United Water (present Ondeo

or a subsidiary of Suez Lyonnaise des Eaux) and American Water Works (a subsidiary of Thames Water under RWE). However, fully privatized water utilities are very few in number and most water utilities adopt a public-asset-ownership and private-management system on a basis of public-private partnership. It is said that 85 percent of the population are serviced from public water utilities, 15 percent from some sorts of partially privatized water utilities.

Meanwhile, not a few developing countries are turning to the private sector for help in developing and delivering water services because they hope to take advantage of private sector skills and know-how, improve the efficiency of service delivery and gain access to finance for new investments to meet the huge demand. Several international water companies, especially those of France and England have actively been involved in the privatization of water utilities in developing countries.

Table-3 shows the Classification of Privatization Types from a viewpoint of partnership between public and private sectors.

**Table-3 Classification of Privatization Types
(from a viewpoint of partnership between public and private sectors)**

Type (Term)	Description	Characteristics	Ownership	Financing	Management	Example	
Partial Privatization	Farming-out (Service Contract) (3-5 years)	*Management of some part of business in a water utility is referred to a private sector for a certain period.	*Compensation is paid based on actual achievement. *The company can easily negotiate the contract and run the business at low-cost, but tends to be suffered from political interference.	Public	Public	Private	Chile
	Contracting-Out (Management Contract) (5-10 years)	*The rights of operations and maintenance for some facilities are given to a private sector.	*Compensation is paid based on actual achievement (adopted in case full privatization is difficult)	Public	Public	Private	France Spain
	Leasing (5-15 years)	*All the facilities are leased to a private company, which are managed under the responsibility of the company.	*Target performance is set.	Public	Public	Private	France
	Concession (25-35 years)	*All the business responsibility is handed over to a private company for a certain period.	*An independent regulatory committee is established. *Results of the operation affect the profit performance.	Public	Private	Private	France Spain
	BOOT (BOT, BOO, etc.) (20-25 years)	*A private company builds some facilities with private funds, owns and operates them during the contract period, followed by transferring the ownership to the public sector.	*Effect of privatization is a little. *The private company is free of responsibility for the existing assets and management.	Private ↓ Public	Private	Private	Mexico China
	Joint Public-Private Venture	*A joint venture is established by public and private sectors.	*The public sector plays a dual role of a regulatory body and a business owner, which creates a clash of interests.	Public and Private	Public and Private	Public and Private	
Full Privatization	Divestiture (Totally Private Ownership)	*All the assets of a water utility are sold by e.g. offering the stocks to the public, and the management of water supply business is entrusted to a private company.	*The private company is under control of the regulatory system.	Private	Private	Private	England Wales

3. INITIATIVES TOWARD PRIVATIZATION IN JAPAN

Situations surrounding water utilities in Japan can be summarized as follows:

- (1) Water utilities, in principle, have long been managed by municipalities.
- (2) There is no private company that is capable enough to undertake the entire technical operation of a water utility, let alone, its entire business management.
- (3) Small-scale water utilities that constitute an overwhelming majority need to merge with neighboring utilities to overcome increasing management costs and a shortage of human resources.
- (4) Municipal governments that supervise water utilities are facing financial constraints.
- (5) The PFI Promotion Act was enacted to enable private sector's participation in public sectors.
- (6) The Water Works Law was revised to enable private companies to undertake the entire technical operation of a public water utility and to facilitate water utilities merging with neighboring utilities.
- (7) The government, through its Administrative Reform Committee, encourages deregulation policies including privatization.
- (8) Privatization of water utilities is now a global trend.

Judging from all this, some kind of privatization of water utilities in Japan seems to be unavoidable in the future. However, it still remains as an open question when, how and to what extent and degree it is going to be materialized. Although privatization of water utilities has been an issue frequently discussed in Japan these days, most Japanese are still thinking that there is no realistic prospect of going beyond the further expansion of outsourcing by public water utilities.

There will be the following incentives for private companies to participate in water services.

- (1) Water is one of the basic commodities essential to life and, thus, the market is fairly stable.
- (2) The domestic market is as huge as US\$ 25 billion per year for water services alone, or US\$ 40 billion including sewerage service.
- (3) Unlike power supply, the balance between demand and supply is easily attainable in water supply, because the fluctuation of demand can be absorbed by reservoir/distribution facilities.
- (4) Since the market ranging from raw procurement (raw water intake) to delivering goods (distributing treated water to customers) is closed from overseas, there is no substantial competition in price (water rates) with foreign suppliers.
- (5) Technical and managerial expertise to be accumulated in privatized water utilities in Japan could be used by private companies for promoting their business in the huge international market where privatization of water utilities tends to proceed in the future.

Since a water supply, regardless of whether it is domestic or international, is a highly potential and attractive market for private sectors in the future, several private companies willing to challenge this have recently been established in Japan. They are looking for business opportunities in the coming privatization age of water utilities.

Table-4 shows the names of newly established Private Water Companies in Japan.

Table-4 Private Water Companies in Japan

Name of Company	Equity Participant
NJS E&M	Nihon Joge Suido(NJS)
TOPS Water	Kubota, Nihon Suido Consultants
J-TEAM	Ebara, NJS E&M, etc.
Japan Water	Mitsubishi, Nihon Health
Marubeni-Vivendi Environment	Marubeni, Vivendi
Japan Utility Management	Vivendi, OnyX, Marubeni, Taisei Engineering
Tames Water Japan	Mitsui, Tames Water
Vivendi Water Japan	Vivendi
MS Water	Shinko Pantech, Meiken
Aqua Partners	Tokyo Engineering
Meidensha	Meidensha
Hitachi Public Services	Hitachi
Toshiba Aqua Public Technos	Toshiba, Toshiba E&M Services

4. SOME CONSIDERATIONS ON PRIVATIZATION

Table-5 presents a summary of advantages and disadvantages to be brought about by introducing Full Privatization. There are some considerable disadvantages, which need to be contemplated when discussing this privatization option.

- **Type of Privatization:** Except in the United Kingdom, there have been very few cases of full privatization in the world, which involved the divestiture of assets. It is generally believed that private companies are inappropriate for water supply business, because water is a commodity essential to life, water supply business is a regional monopoly, and there is no substitute available for consumers except bottled water. Shifting employees from public utilities to private companies might face strong oppositions from public utilities' labor unions. In addition, there is actually no reliable private company experienced in water supply business.

In Japan, the full privatization of water utilities is far from the reality, and nobody really believes that it can be materialized in the near future. It will take a long time before a public consensus can be reached on the realization of fully privatized water utilities as well as on the development of related laws.

Most likely, the current public-management system, will continue for some time with a gradual expansion in outsourcing, then a public-asset-ownership and private-management system, e.g.: leasing, concession, majority share holding by local governments, etc, will follow. After building up their experiences, some water utilities may change to fully privatized entities in the future.

- **Regionalization (Wide-area Services by Integration):** The recent revision of the Water Works Law (from the previous licensing procedure to notification procedure) was expected to accelerate the regionalization.

In reality, however, the regionalization through the merger of adjoining public utilities has not taken place to the extent it was originally expected because of the following dilemma:

- Under the Local Public Enterprise Law, public water utilities cannot pursue profits, but must pursue the welfare of local residents.
- The merger of two or more public water utilities tends to result in the inequitable distribution of the resulting advantages or disadvantages among those water utilities,

since each public water utility has different backgrounds in terms of the level of services, size and quality of assets, and water rates.

In conclusion, integration of water utilities can be easily achieved only when the relevant entrusted water utility is a private company not controlled by the Local Public Enterprise Law, or all would-be parties for a merger are public water utilities operating within the same administrative area of prefectural jurisdiction.

Table-5 Advantages/Disadvantages of Privatization (in case of Full Privatization)

Recipient	Advantage	Disadvantage
National Government	Creation of Profit on Stock Sale *Profit on sale is expected by public offering of stocks held by government.	Increase in Costs by Regulations *It is necessary to establish a regulatory body/system for the management of private companies.
Local Governments	Decrease in Subsidies *Financial pressure on government is mitigated due to abolition of subsidies for water utilities.	Delay in Consolidation of Water Administration *There is a fear of segmentalization in the water sector, if privatization is carried on before a comprehensive water management system establishes.
	Increase in Tax Revenue *A corporate tax, a fixed asset tax, etc. can be collected from privatized companies.	
		Increase in Tax Burden *Private companies shoulder new burdens such as a corporate tax, a fixed asset tax and road-occupancy charges, which a public sector does not pay.
	Diversification/Liberalization of Management *Business regulations applied to public utilities are abolished. *Private companies can enter the profitable business.	Abolition of Grants-in-aid *Private companies cannot receive subsidies from governments.
Water Utilities	Liberalization of Financing *It is possible to raise funds in the general market. *Investment funds can be easily raised by using various means.	Adverse Effects based on Market Mechanism *Privatization cannot provide incentives for ensuring the safety and achieving the higher level of performance when investing.
	Increase in Business Efficiency *Staff members can be reduced by promoting outsourcing, consolidation of business, etc. *Incentive effect by psychological pressure of being market mechanism is expected.	Increase in Fund Cost *Private companies should pay higher interests of commercial banks than those of public bonds and a public loan corporation when raising funds.
Customers	Decrease in Water Rates *Huge reductions in water rates are expected due to an increase in business efficiency.	Widening of Regional Gaps *Water utilities in only profitable areas are to be privatized and customers in unprofitable areas cannot receive the benefit.
	Prompt/Diversified Services *Necessary measures and policies are swiftly implemented due to prompt decision-making. (Private sectors strive for grasping needs.)	Anxiety about Management by Private Sectors *There is a vague anxiety that privatization emphasizes to pursue profits and self-responsibility. *There is a vague hope for a public sector.

- **Methods for Regionalization:** On adopting the regionalization, business profitability should be considered. Generally, small-scale water utilities are absorbed by a larger one and they usually, more or less, come to a standstill caused by some difficulties in water sources, facilities, human resources, financing, etc. In this case, it is needed that a larger water utility can bear the burden with ample own funds or the help of some public funds. Such cases are to be adopted by public water utilities each other and scarce in private water supply companies.

In conclusion, regionalization by private water supply companies will be carried out targeting at not small-scale but lucrative medium- or rather larger-scale water utilities.

In addition, regionalization works on concurrent adoption of a common carriage system mentioned below.

- **Common Carriage System:** The merit of regionalization is that improvements in business efficiency and water services are expected by sharing the waterworks facilities such as water sources and purification plants. When a water utility aims for the implementation of regionalization, the targeted water utility is not always situated next to it. According to the revised Waterworks Law, it is not necessary that the relevant two water utilities are connected by a pipeline each other. However, such case spoils the merit of regionalization. Then, a connecting pipeline between two utilities is generally needed. Since the construction of connecting pipes generally needs huge funds, a common carriage system, already adopted in the power industry, is recommended. The flow capacity of water mains laid in more than medium-scale water utilities is generally designed with tolerance. Then, not a few suitable water mains for the common carriage system may be found after the further study, if the flow is not too much. Once the system is implemented, residents of other water utilities nearby the relevant ones may receive the water services at the lower water rates in the future. Spread of this system will cause the natural selection of unfavorable water utilities, followed by the correction of regional differences.

The common carriage system has some problems to be solved as a matter of operation, e.g.: its application is limited in hydraulics, a difference in water quality should be accepted, etc. However, earnest investigation is really hoped, because if it is implemented, it will remove the concept that a water supply is the regional monopoly business, and consequently accelerate the privatization of water utilities.

- **Tax Payments:** At present, a corporate tax of public water utilities is exempted, a fixed asset tax for waterworks facilities is partially exempted and road occupancy charges for pipelines are exempted. When they are fully privatized, these taxes and public dues are imposed in principle and may reflect on water rates. However, this issue is a matter of whether they are charged on water users or are redistributed to citizens as public levy. This kind of issue on tax burden after the privatization should be decided through national discussion.

- **Development of Related Laws:** Although the Water Works Law was recently revised, there still remains "a principle of public-management system of water utilities by municipalities". So, it is needed to fully review the Water Works Law with no principle in management of water utilities, when people really want the full-privatization. Since water utilities are highly public-interest-oriented ones and have a strong regional monopoly nature, even if the said common carriage system is to be developed, pricing of water rates and sound management of the privatized water utilities should be strictly supervised by a public independent organization.

Whereas, the present Local Public Enterprise Law does not assume the share holding of 100 percent of a corporatized public enterprise by the relevant local government. If a large-scale water utility like Tokyo would escape from various controls of being a public entity by corporatizing as it is, it could have enough ability to compete with any other private water supply companies. And if the local government would hold all the shares, the corporatized water utility could provide a sense of ease to the customers. Since this kind of privatization will be a potent method, the revision of the said law is desired.

In Japan many ministries concerned are intricately involved in laws concerning water resources with a central focus on water rights. A private water supply company that is

given the management of a public water utility in trust may succeed to existing water rights. (Note: According to the present River Law, assignment and borrow/lending of water rights are prohibited. In case the operating body takes a turn, water rights should be newly acquired with a very difficult manner.) However, it is very difficult for the private company to get new water rights or develop new water resources due to a red-tape jungle with many authorities concerned and securing huge funds. Since these procedures exceed private company's ability, they should be entrusted to the governmental agencies by developing water resources related laws including measures against water pollution.

- **Weaknesses of Existing Private Water Supply Companies in Japan:** As described before, since almost 100 percent of water utilities in Japan are managed by public sectors, there is no private water supply company that has ever managed the water utilities. This means existing private companies have no know-how on management of water utilities as a whole. Then, when a private company undertakes a contract of the management of a public water utility, the public water utility is obliged to deeply involve in the actual management somehow. On the contrary, when an existing public water utility is fully privatized, the public water utility has no other choice than to be a private water supply company as it is.

- **Overseas Presence of Private Water Supply Companies:** Privatization feelings are rampant in the waterworks industry of Japan. However, private companies in Japan cannot tender bids for overseas privatization related matters by themselves due to the reason of no experience in operation of water utilities. Recently, water utilities in developing countries are also caught in a storm of privatization. However, when Japanese waterworks related companies with enough experience and performance in each field of expertise want to tender bids, actually they must give up the bids or partner with foreign private water supply companies, despite Japan has greatly contributed to the development of water utilities in developing countries through ODA.

In conclusion, it is imperative for Japanese waterworks related companies to establish track records of the management of water utilities in order to break into the huge market of water supply in the world as well as in Japan.

- **Privatization of Sewerage Works:** This paper has mentioned the privatization of water utilities focusing on only waterworks. However, it is needed to refer to a sewage system. There are two kinds of sewage water, wastewater and rainwater. The latter is not suitable for the argument of privatization. Especially, concerning a sewage system adopting a combined system for collecting/treating sewage water, like Tokyo, there is no point in arguing the full-privatization. However, since designing, construction, and operations and maintenance of treatment plants and pipelines of sewerage works closely resemble those of waterworks, high efficiency in these fields is promising by operating them integrally.

In conclusion, as for privatization of sewerage works, there is no opportunity of full-privatization and it is preferable to integrally operate the fields of designing, construction, and operations and maintenance of waterworks/sewerage-works facilities in a form of the public-asset-ownership and private-management system.

5. CONCLUSION – A Possible Example of Privatization in Japan

If privatization of water utilities were inevitable, then what would be the most appropriate method of privatization, given the circumstances of water utilities in Japan? This chapter

provides the author's answer to this question.

Even when privatized, a public water utility needs to be continuously involved in the operation and management of the newly privatized water services at least during the initial stage of transition, since there is no private company in Japan at present, which can operate and manage water services all by itself. This leads to the author's opinion that a medium-scale or a large-scale public water utility should first establish a third-sector water supply company and send its personnel to work for the company. It is preferable in this case that several public utilities participate in the third-sector water supply company. It should be noted that many large public water utilities, including the Tokyo Metropolitan Waterworks Bureau, already have such third-sector companies, but each of them is usually operating independently from others to provide certain specific services, e.g. pipe maintenance and pump operation, on-line system, mapping system, development of unused land, district heating and cooling, meter reading, etc.

In the meantime, the newly established third-sector water supply company should encourage the participation of those private companies that have know-how and expertise in water services, as well as of financial institutions and trading firms which have adequate financial resources and managerial expertise. The participation of those private companies and institutions is essential to the efficient operation and management of water services to avoid adverse effects of bureaucracy.

In its early stage of operation, the new company would be able to maintain its sound finance by undertaking part of water services entrusted by the original public water utilities. Through this process, the company could gradually accumulate within itself both technical and managerial expertise that is needed to undertake the entire water services. Meanwhile, the existing public water utilities take charge of the core business as the role of public utilities, such as the protection/development of water resources, management of assets, pricing of water rates, making long-term plans and strategies, and other policy and regulatory matters. The company would eventually be able to enter into a lease contract, concession, BOOT (Build, Own, Operate and Transfer), or any other type of contracts depending on the circumstances.

The company should gradually expand its area of operation under contracts with neighboring public utilities by establishing several regional subsidiaries all over the country. Such an expansion is necessary for exploiting the area diversification of skilled manpower, enhancing cost-effectiveness with economies of scale and scope, and competing with gigantic foreign companies in the global market.

Being public servants, the employees of water utilities in Japan are rather conservative on the issue of privatization. Besides, most medium-scale and large-scale public water utilities have been operated to date without any serious financial, social, or technical problems. It is therefore an emerging social question whether or not water services should or can be fully relinquished to private companies.

At any rate, it would probably take a long time before full privatization of public water utilities comes into reality in Japan. And, even when privatized, the management of water utilities is not likely to be relinquished to short-term-profit-oriented companies that operate according to the Euro-American style corporate ethic of "market economy". Instead, it is likely to be relinquished to long-term-profit-oriented companies that give "relief and reliance" to the customers same as public utilities do and operate according to the Japanese style corporate ethic of "human-network-dominant philosophy" in that the

interest of equity holders comes only after that of consumers and employees.

There are several different methods of privatization, and it is not an easy task to decide on which is the most appropriate method for water utilities and consumers in Japan at this point in time. And, that is why the author has the opinion that the partial privatization should be the first approach to be made, and based on the lessons learned through this process, a final decision should be made by citizens on whether or not full privatization is a realistic and viable option in Japan.

End of Paper

References:

(1) Report of Trends of Privatization in Waterworks/Sewerage-Works Sector: Experiences in Developing/Developed Countries, Japan Bank for International Cooperation, January 2000, (2) Investigation Committee Members of Japan Water Works Association, Report of Investigation on Privatization of Water Utilities, Suido-koron, December 2000, (3) Saito H., Conceiving Privatization of Water Utilities in The World, Japan Water Works Association Journal, Vol. 777&780, 1999, (4) Saito H., Privatization of Water Utilities and Ideal Public-Private-Partnership, Suido-koron, March-July 2002, (5) Miyao S., Trends of Privatization in Its Advanced Countries and Privatization of Water Utilities, Suido-koron, January 2001, (6) Annual Report of Water Supply in Japan, Japan Water Works Association, May 2002

29. Privatization in the US Water Industry & Factors Affecting

It

Presenter

Peter L Cook, National Association of Water Companies

Privatization in the US Water Industry & Factors Affecting It

Japan/US Water Industry Conference
October 21-24
Tokyo, Japan

NAWC

- Trade association representing over 200 private and investor-owned water companies
- Members serve 21 million Americans in 42 states and have sales of about \$3 Billion
- We are taxpaying businesses and our rates are regulated

Topics to be Discussed

- Market Share of Private Utilities
- Regulation of Drinking Water Utilities
- Trends in the US Water Industry
- Economic Characteristics of the Industry
- Municipal Role in Privatization

Topics to be Discussed

- Facts on How Privatizations have Performed
- Why Privatize
- Obstacles to Privatization and Critical Elements for Success

Percentage of Population Served by Private Utilities

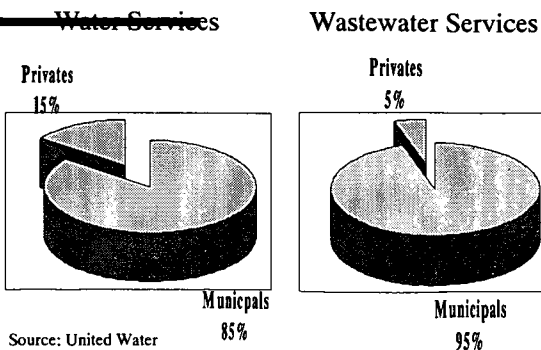

Regulation of Drinking Water Utilities in the US

Regulation of Water Utilities

- Both municipal and private water utilities must meet health standards established by EPA and enforced by the states
- Private water utilities are also regulated by the state public utility commissions (PUCs), who approve capital expenditures, establish allowable rates of return, monitor service, and set rates

Regulation

- ◊ PUCs exist to prevent private utilities from exercising monopoly power
- ◊ PUCs also regulate private gas, electric, and telephone utilities
- ◊ Municipal water utilities are not generally regulated by PUCs
- ◊ Mayors, who should be sensitive to demands of their customer/voters, are the only control over rates and service at municipalities

Definition of Privatization & Public Private Partnership

- ◊ Privatization is a broad term including everything from sale of municipal assets to the private sector to setting up various public private partnerships (P³)
- ◊ All these forms of privatization involve a redefinition of the roles of the private and public sectors

Trends in the US Water Industry

Their Impacts on the Industry & Privatization

Trends - Market Players

- ◊ Private water industry consolidating rapidly
- ◊ Municipal utilities not selling their assets but are contracting out many functions
- ◊ Many non-utility and foreign companies are entering the market

Trends - Deregulation

- ◊ Other private utility sectors (gas, electric, and telephone) are being deregulated at both the federal and state levels
- ◊ Differences between water and the other utilities are likely to make deregulation impractical in the water sector
- ◊ However, alternative regulation to enhance competition and efficiency are likely

Trends - EPA Regulation

- Future will bring increasingly stringent regulations - vulnerable subpopulations must be considered
- Monitoring advances and public concerns will continue to drive more stringent rules & enforcement

Trends - EPA Regulation

- Need for significant capital and technical expertise may strain municipal capabilities, opening privatization opportunities for IOUs

Trends - Privatization

- British model not being implemented here.
- Wastewater more active than DW
- Larger investor owned companies are bidding on P³ opportunities as are non-utility companies
- ConOps is fastest growing area and has significant competition

Economic Characteristics of the US Drinking Water Industry

Capital, Costs, Prices

Capital Intensity: Ratio of Plant to Revenues

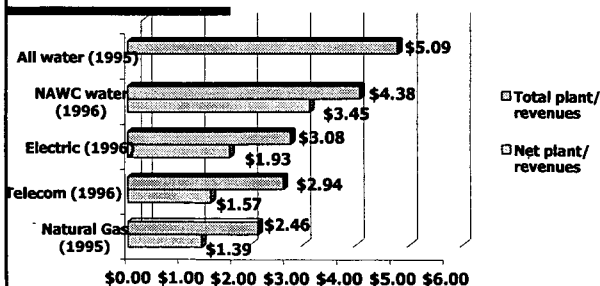

Source: Beecher Policy Research, Inc.

Water Capital Needs

- Infrastructure capital needs over the next 20 years are staggering
- Most of the need is for transmission and distribution

20 Year Water Capital Needs

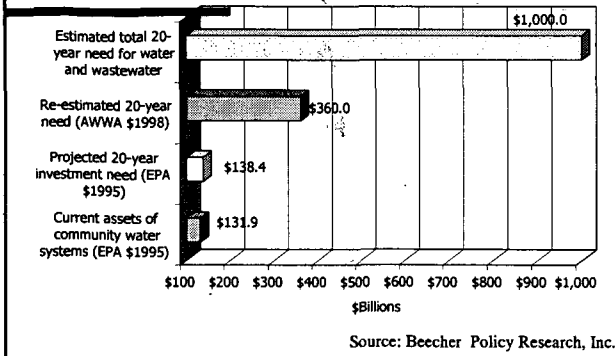

Specific Infrastructure Needs

20 Years

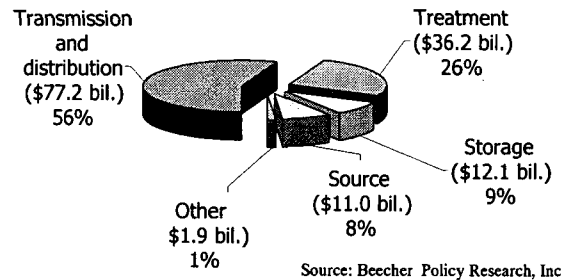

Municipal Role in Privatization

- All privatization decisions are local
- Threat of privatization has stimulated municipals to try to improve efficiency

Municipal Role in Privatization

- While many will succeed, many will not and will be compelled to consider some form of privatization
- The recession and anemic economic recovery has reduced municipal tax revenues and put pressure on city budgets.

Facts on How Privatizations have Performed

Our Experience with Privatizations

- Debate about privatization driven by philosophical and political arguments rather than facts
- NAWC sponsored a study conducted by the Hudson Institute to get the facts about reasons for privatization and performance
- Study shows that privatizations deliver

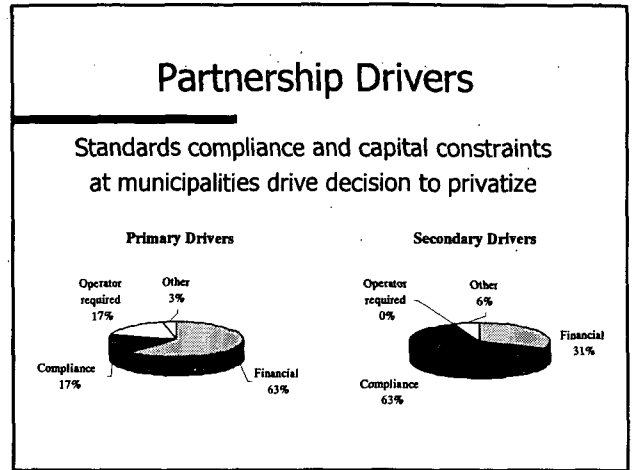
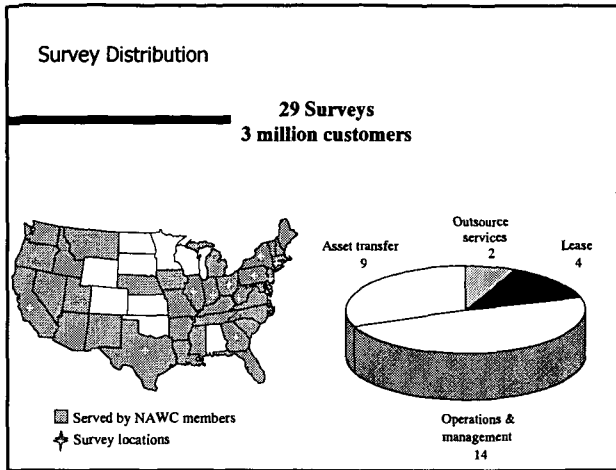

Partnership Benefits

Compliance

- 41% of facilities were out of compliance before privatization
- 100% were in compliance 1 year after privatization

Partnership Benefits

Increased Financial Support

- \$55 Million in capital expenditures
- \$35 Million in concession fees
- \$537 Million in asset transfer fees

Partnership Benefits

Service Improvements

- Water Quality and Delivery
 - Taste, odor improvements
 - Correction of low pressure/shut-offs in all cases
- Customer Service
 - Specific municipalities experienced 50% reduction in customer complaints
 - No evidence of increased customer complaints
 - Reduced call waiting times

Partnership Benefits

Additional Benefits

- Cost Savings
 - 17% of facilities experience cost savings between 10% and 40%
- Rate Stabilization at Private-Operated Facilities
 - 25% of projects surveyed faced major rate increases due to investment backlog
 - P³ operating efficiencies soften major rate increases in all cases

Privatization Survey Summary

- Provides capital
- Improves compliance
- Enhances service
- Mitigates potential rate increases

Why Privatize?

Increasing Resource Needs

- * More stringent water quality regulations
- * Compliance problems at some munis
- * Huge infrastructure replacement costs and backlog of deferred muni investments
- * Accelerating non-water municipal capital needs
- * Inability of municipal capital markets to generate necessary capital to meet all needs

Less Government Help

- ◊ Virtual elimination of federal wastewater infrastructure grants
- ◊ Only part of loss made up with state revolving loans for water and wastewater
- ◊ Constrained state and local budgets and frequent operating deficits

Higher Public Expectations

- * Improve operating efficiencies and keep rates under control
- * Improve quality and reliability
- * Meet needs of economic development

Solutions Offered by Private Sector

- ◊ Private sector has access to substantial sources of new capital
 - Helps municipalities meet capital needs
 - Frees up municipal resources and debt capacity for other needs
- ◊ Private sector has significant technical and operational expertise and a record of efficiency
 - Compliance is consistently achieved
 - Operational savings can be significant

Obstacles to Privatization & Critical Elements for Success

Obstacles to Privatization

- * State laws and regulations
- * Municipal union opposition because of fear of loss of job or benefits
- * Political risk from loss of control if sell assets
- * Lack of expertise in many smaller cities to manage a privatization
- * Resistance of municipal managers
- * Absence of a champion for privatization

Critical Elements for Success

- * Full and open competitive bidding is essential on both asset sales and contracts
- * Focus of analysis should be what best meets the needs of the consumer and the municipality
- * Credible third party comparative analysis of bids is important

Critical Elements for Success

- * Agreements must clearly specify all terms of the arrangement
- * Municipality must diligently monitor performance - only performance will foster more privatization

**30. Procedures of Choosing Wastewater Reclamation
Methods to Assure Safety against Virus Infection**

Presenter

Mr. Yutaka Suzuki, Public Works Research Institute

PROCEDURES OF CHOOSING WASTEWATER RECLAMATION METHODS TO ASSURE SAFETY AGAINST VIRUS INFECTION

**Yutaka SUZUKI*, Miyako NAKAMURA*
Mamoru SUWA* and Masashi OGOSHI****

* Public Works Research Institute
Minamihara 1-6, Tsukuba, Ibaraki, 305-8516 Japan

** Japan Sewage Works Agency
Akasaka 6-1-20, Minato, Tokyo, 107-0052 Japan

ABSTRACT

This study attempted to quantify the risk of enteric virus infection in case of wastewater reuse, and to clarify appropriate reclamation methods for safety. To assess the potential risk associated with the use of reclaimed wastewater in various applications, some exposure scenarios were assumed, and enteric virus concentrations in secondary effluents were monitored at ten wastewater treatment plants for 2 years.

The virus concentrations in secondary effluents were distributed according to a lognormal distribution, and annual infection risks (r) corresponding to the scenarios were calculated using the Monte Carlo method. Assuming some virus removal efficiencies (x), annual infection risks (r) were calculated and the relationship between virus removal efficiencies and annual infection risks ($r=f(x)$) was obtained for each scenario. The necessary virus removal efficiency (x_0), satisfying the assumed acceptable annual risk (r_0) under the scenario, was calculated using the equation $r=f(x)$. A virus removal method satisfying the virus removal efficiency (x_0) was chosen using the existing data of enteric virus removal efficiencies of several reclamation methods.

KEYWORDS

wastewater reclamation, enteric viruses, risk assessment, risk management, inactivation efficiency

INTRODUCTION

Sewerage systems collect and treat wastewater discharged from houses and industries, and so could be used to treat pathogens effectively and hence prevent them from spreading in cities.

The population served by sewerage systems reached 62% at the end of fiscal 2000, and about two-thirds of the water used by households now passes through sewerage systems. Therefore, treated wastewater is an alternative water resource in urban areas that offers a plentiful, stable supply of water.

The quantity of treated wastewater was 12.6 billion m^3 in fiscal 1999, of which 150 million m^3 was used outside of wastewater treatment plants, corresponding to 1.2% of the total treated wastewater. Among the reuse purposes, environmental use for

recreation, scenery and water flow maintenance of rivers accounted for about half of the total usage, in addition to many cases of applying treated wastewater for flushing toilets. Thus, urban usage is the dominant form of wastewater reuse in Japan.

However, problems associated with protozoa and viruses have been identified and reported recently, and responses to such problems must be developed.

With this background, a Committee for Reclaimed Water Quality was established to investigate methods of ensuring the safety of reclaimed water against waterborne pathogenic viruses. This paper summarizes the research results of the Committee's activities.

POLICY FOR SECURING THE SAFETY OF RECLAIMED WATER

Securing the safety by reclamation methods

Continuous monitoring of the pathogenic virus concentration in reclaimed water is quite difficult, because it requires much skill and manpower. Therefore, to ensure the safety of reclaimed water against viruses, appropriate reclamation methods must be defined rather than regulating the target virus concentration.

Choosing reclamation methods based on infection risk assessment

For each potential application of reclaimed water, the amount of ingested water in a single exposure and the frequency of exposure were assumed, and the amount of ingested virus was calculated using the concentration distribution of viruses in the reclaimed water. Then, the infection risk was evaluated using the relationship between virus dose and infection probability, and reclamation methods that can achieve an acceptable risk were chosen.

SURVEY AND EXPERIMENTS

Virus concentration distribution in secondary effluent

At 10 wastewater treatment plants, enteric virus concentration was surveyed for two years, and the virus concentration distribution in the secondary effluent was estimated. The sample volume of the secondary effluent was 20 L, and two types of host cells, BGM and Hep-2, were used for virus detection.

The cumulative distribution of virus concentration is shown in Fig. 1, in which the x-axis represents the cumulative frequency expressed as a standard deviation and the y-axis is the virus concentration expressed as a logarithm. A linear relationship was obtained, and so it was assumed that the virus concentration distribution in secondary effluent follows a log-normal distribution. However, care is required because regional characteristics are not taken into account in the relationship, since all the data were analyzed together.

Virus removal efficiency of reclamation method

Pilot plant experiments were conducted to evaluate the virus removal efficiencies of several reclamation methods. Polio virus (vaccine strain) was added to treated wastewater, and experiments of disinfection with chlorine, ultraviolet light and ozone

and sand filtration were carried out. The experiment results are shown in Tables 1 and 2.

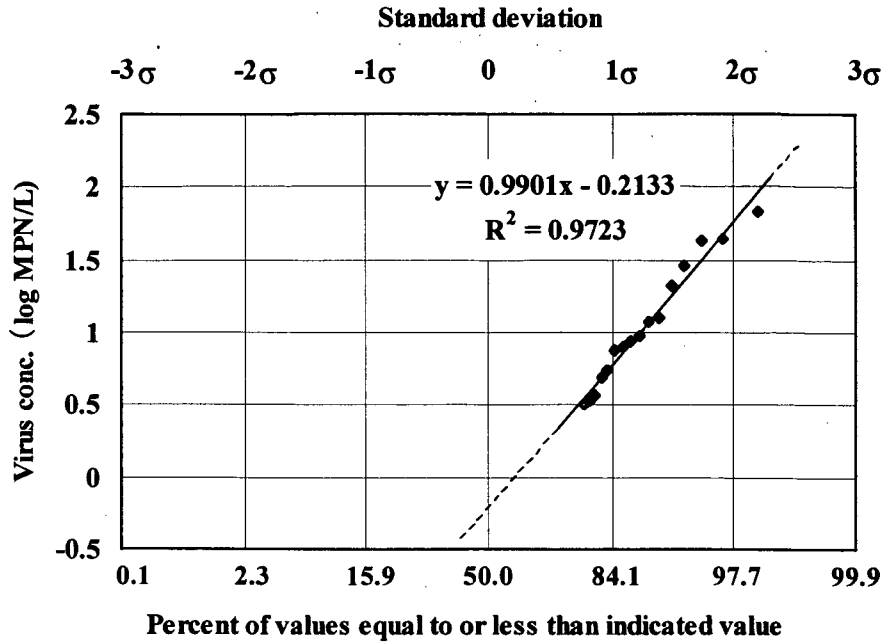

Fig. 1 Cumulative distribution of virus concentrations in secondary effluents

Table 1 Relationships between disinfection intensity and virus inactivation efficiency

Disinfection	Water sample	Turbidity (-)	Indicator of disinfection intensity	Virus inactivation ratio		
				1 log (90%)	2 log (99%)	3 log (99.9%)
Chlorination	Secondary effluent *1	3.0 - 3.5	Injection dose (mg/L) Ct value (min*mg/L) *4	15 150	— —	— —
	Tertiary effluent *2 + NH4-N *3	0.7	Injection dose (mg/L)	7.0	17	—
	Tertiary effluent *2	0.4 - 0.6	Injection dose (mg/L) Ct value (min*mg/L) *4	2.5 3.2	7.9 72	13 140
Ozonation	Secondary effluent *1	3.8	Injection dose (mg/L) Ct value (min*mg/L) *4	16 27	— —	— —
	Tertiary effluent *2	0.4 - 0.6	Injection dose (mg/L) Ct value (min*mg/L) *4	7.6 4.4	13 17	18 29
UV	Secondary effluent *1	3.5	UV dose (mWs/cm²)	980	2,000	—
	Tertiary effluent *2	0.6	UV dose (mWs/cm²)	560	1,200	1,800

—: No data. Significant figure: 2 digits

*1 Secondary treatment: HRT ≅ 8 h

*2 Tertiary treatment: HRT ≅ 13 h + sand filtration

*3 NH4-N was added to the final concentration of about 10 mg/L.

*4 "C" (= concentration) means residues, not dose. "t" (= contact time) is 15 min.

Table 2 Virus removal efficiency and turbidity reduction by sand filtration

Water Sample	Virus conc. (PFU/mL)	Virus removal ratio	Turbidity (-)
Before filtration (Secondary effluent)	9,000		3.5
Filtered sample (100m/day)*	4,000	0.36 log (56%)	1.1
Filtered sample (200m/day)*	6,500	0.14 log (28%)	1.2

Significant figure: 2 digits

DOSE-RESPONSE MODEL USED IN THE RESEARCH

The Beta-distributed probability model (Rose and Gerba, 1991) was used, which assumes that the infection ability of individual pathogens differs according to the number of pathogens ingested.

$$P(D) = 1 - (1 + D/\beta)^{-\alpha}$$

P: infection risk in a single exposure

D: ingested virus in a single exposure

$\alpha = 0.232$, $\beta = 0.247$ (value of the rotavirus)

PROCEDURE FOR SELECTING RECLAMATION METHOD

The procedure for choosing the reclamation method to secure the safety of reclaimed water is outlined in Fig. 2.

Firstly, assume the amount of ingested reclaimed water in a single exposure and the frequency of exposure, based on the conditions and situation of reuse.

Then, calculate the amount of ingested virus in a single exposure from the amount of ingested water and the virus concentration distribution, and obtain the infection risk in a single exposure using the virus dose-response relationship (procedure A).

The Monte Carlo method is applied, because the virus concentration shows the distribution (Tanaka et al., 1998). To obtain the annual risk of one person being infected, procedure A is repeated the same number of times as the exposure frequency per year (procedure B). Procedure B is repeated 500 times, to choose the value at 2.5% from the top as the annual infection risk of reuse (procedure C). Assuming several virus removal efficiencies of reclamation methods, which produces lower virus concentration distributions, the annual infection risk is calculated by following the series of procedures A, B and C.

From these calculation results, obtain the relationship between virus removal efficiency (x) and annual infection risk (r) in the form of $r=f(x)$.

Determine the acceptable annual infection risk (r0), and calculate the necessary virus removal ratio (x0) to achieve the acceptable risk with the relationship of $r=f(x)$.

Compare the removal efficiencies of reclamation methods with the required removal efficiency (x_0), and then choose the appropriate method to achieve x_0 .

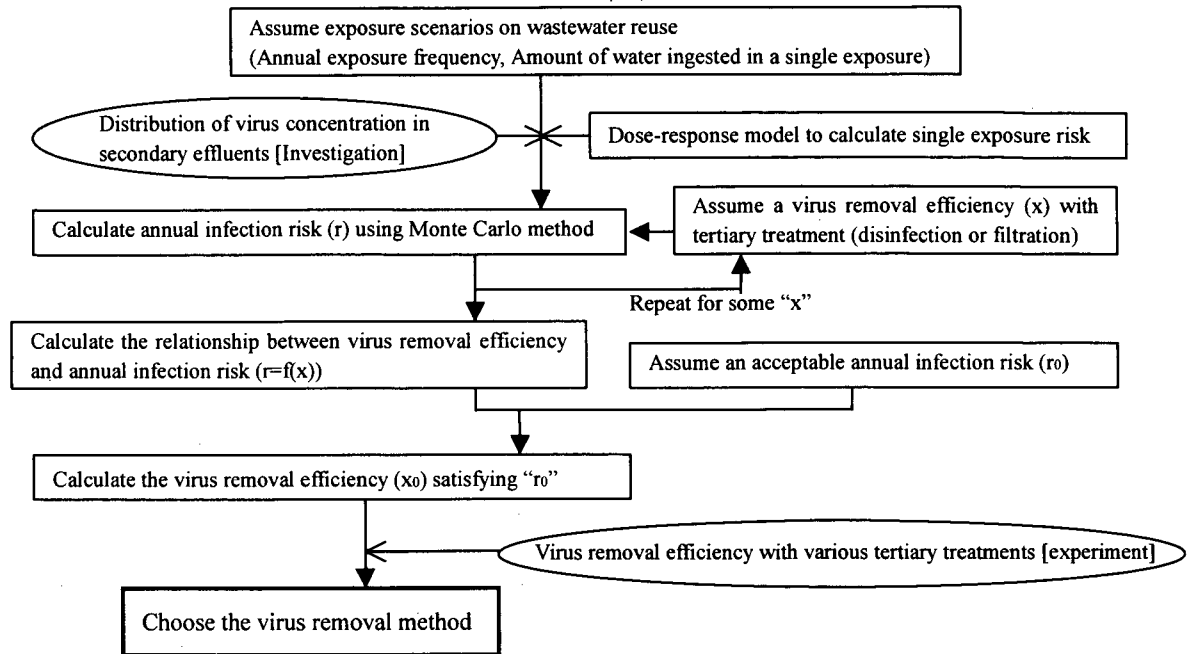

Fig. 2 Procedure to choose the virus removal method for wastewater reuse

EXPOSURE SCENARIOS AND RESULTS OF RISK CALCULATION

Setting exposure scenarios for each reuse purpose

Exposure scenarios for each reuse purpose, which are composed of ingested reclaimed water in a single exposure and the frequency of exposure, were set as shown in Table 3. The basis of the scenarios is explained in Table 4.

Table 3 Exposure scenarios assumed for wastewater reuse

Application purpose	Route of ingestion	Amount of water ingested in a single exposure (mL)	Exposure frequency per year
Recreational pond or stream (possible to swim)	Direct drinking	30	8
Recreational pond or stream (possible to bathe feet and hands)	Indirect ingestion from wet hands	0.3	20
Waterfall or fountain (large-scale)	Direct ingestion of spray	1	10
Fishing pond	Indirect ingestion from wet hands	0.2	20
Lawn irrigation	Indirect ingestion from wet hands	0.1	20
Toilet flush	Direct ingestion of spray	0.02	3

Table 4 Basis of the exposure scenarios (Table 3)

Application purpose	Amount of water ingested in a single exposure	Exposure frequency
Recreational pond or stream (possible to swim)	The amount of water in one gulp	Two days per week, for one month in the middle of summer
Recreational pond or stream (possible to bathe feet and hands)	Ten percent of the water on a wet hand	Two days per week, for 10 weeks in the summer
Waterfall or fountain (large-scale)	Ten percent of the water needed for humidifier (referenced from catalogue) 30 min. ingestion	One day per month, for 10 months excluding winter
Fishing pond	Half of the amount of water on a hand when a wet cylindrical paper-towel is grasped	About two days per month, for 12 months
Lawn irrigation	Ten percent of a golf player's exposure (referenced from another study (Asano et al., 1992); the golfer may touch irrigated greens and wet balls	About two days per month, for 12 months
Toilet flush	One-third of a drop of water from a 5 mL pipette	Using the toilet in the office once a day, 5 days per week, for 12 months. Ingestion possibility is once per 100 times flushing

Results of risk calculation

For each reuse purpose, several virus removal efficiencies were assumed, and annual infection risks were calculated based on the exposure scenario and the virus concentration distribution. The results are shown in Fig. 3.

CHOOSING THE RECLAMATION METHOD

To choose a reclamation method, the acceptable annual risk must be determined. However, as there is much argument as to the acceptable risk, we do not go into details here, but merely set three annual risks, 10^{-2} , 10^{-3} and 10^{-4} .

Then, using the relationship between virus removal efficiency and annual infection risk (Fig. 3), virus removal efficiencies required to achieve the annual risk were obtained as shown in Table 5. Reclamation methods satisfying the required virus removal efficiencies will be chosen from Tables 1 and 2.

The results of choosing reclamation methods, taking chlorine disinfection as the example, are shown in Table 6 for the acceptable risk of 10^{-3} .

In the case of possible swimming, the required virus removal efficiency was 3.8 logs, and no reclamation method within the conditions of Tables 1 and 2 could satisfy the removal efficiency. In this case, it is necessary to investigate the virus removal efficiency at a much higher disinfection intensity, or the reuse application itself must be reconsidered.

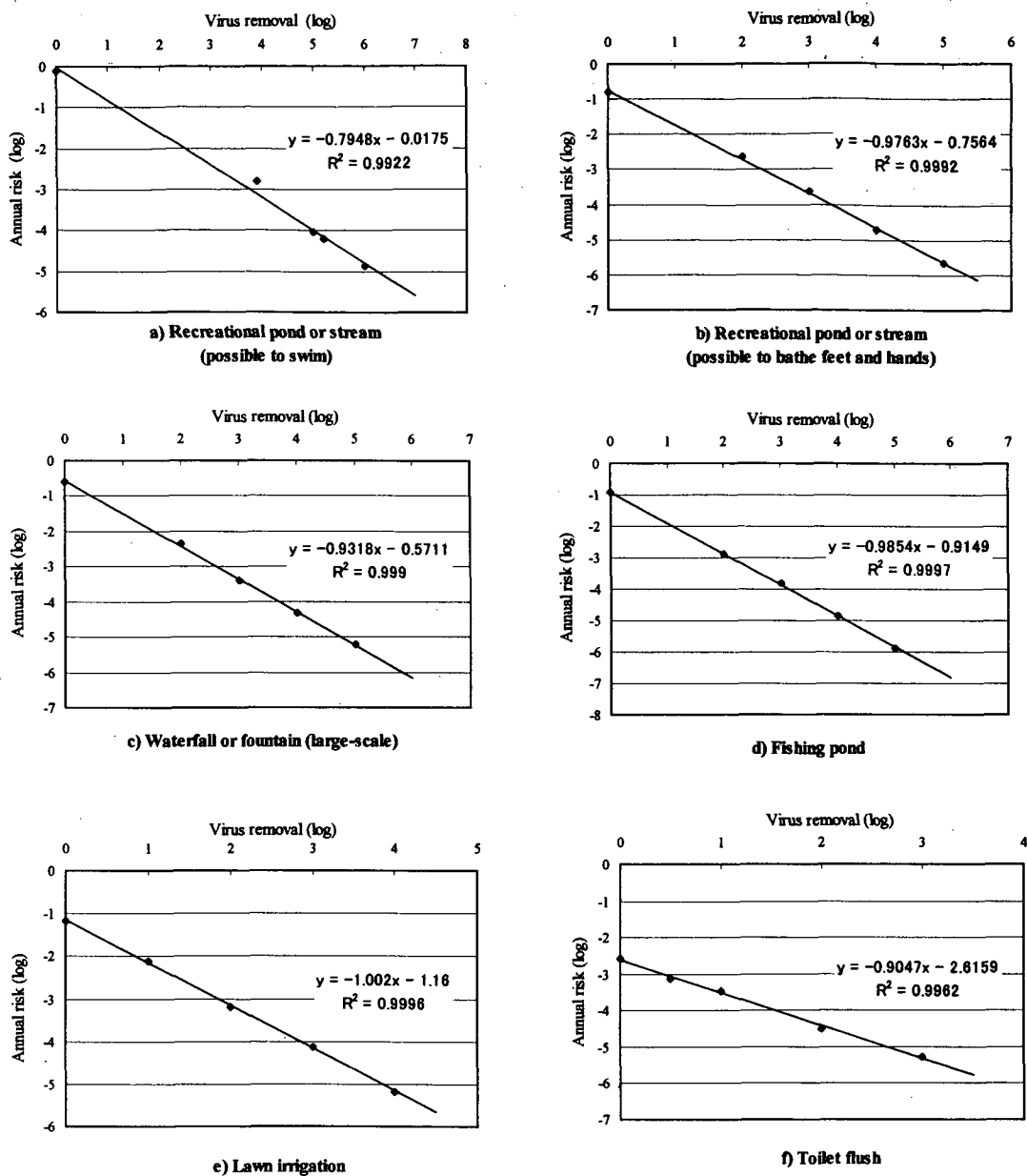

Fig. 3 Relationships between virus removal efficiencies and annual risks of infection

On the contrary, when reclaimed water is used for flushing toilets, the required virus removal efficiency is only 0.43 logs, and the chlorine dosage of 2.5 mg/L is sufficient for tertiary effluent.

In the case of possible bathing of hands and feet, the required virus removal efficiency is 2.3 logs, which could not be achieved if the source water is secondary effluent, but could be achieved with 17 mg/L of chlorine dose after sand filtration, even if the water contained $\text{NH}_4\text{-N}$.

Table 5 Required virus removal efficiencies to satisfy each annual risk of infection

Application purpose	Required virus removal efficiency		
	Annual risk: 10^{-2}	Annual risk: 10^{-3}	Annual risk: 10^{-4}
Recreational pond or stream (possible to swim)	2.5 log (99.68%)	3.8 log (99.98%)	5.0 log (99.999%)
Recreational pond or stream (possible to bathe feet and hands)	1.3 log (94.63%)	2.3 log (99.50%)	3.3 log (99.95%)
Waterfall or fountain (large-scale)	1.5 log (97.05%)	2.6 log (99.76%)	3.7 log (99.98%)
Fishing pond	1.1 log (92.06%)	2.1 log (99.24%)	3.1 log (99.93%)
Lawn irrigation	0.84 log (85.55%)	1.8 log (98.56%)	2.8 log (99.85%)
Toilet flush	(No need to remove)	0.43 log (62.42%)	1.5 log (97.05%)

The exposure scenarios are based on Table 3.

Table 6 Required chlorine disinfection intensity to satisfy annual risk of 10^{-3}

Application purpose	Required virus removal efficiency	Source water for disinfection	Required chlorine dose
Recreational pond or stream (possible to swim)	3.8 log	Secondary effluent	(Out of the range of Table 1)
		Tertiary effluent + NH ₄ -N	
		Tertiary effluent	
Recreational pond or stream (possible to bathe hands and feet)	2.3 log	Secondary effluent	(Out of the range of Table 1)
		Tertiary effluent + NH ₄ -N	17 mg Cl/L
		Tertiary effluent	8 mg Cl/L
Toilet flush	0.43 log	Secondary effluent	15 mg Cl/L
		Tertiary effluent + NH ₄ -N	7 mg Cl/L
		Tertiary effluent	2.5 mg Cl/L

CONCLUSIONS

Procedures for choosing wastewater reclamation methods for ensuring safety against enteric viruses were developed based on a virus survey of 10 treatment plants, pilot plant experiments for virus removal, exposure scenarios for each reuse application and risk assessment.

Further research is needed to improve the procedure with detailed information about the

virus concentration and infection ability, supported by appropriate methods for setting the acceptable risk.

REFERENCES

T. Asano, L. Y. C. Leong, M. G. Rigby, and R. H. Sakaji (1992) Evaluation of the California Wastewater Reclamation Criteria Using Enteric Virus Monitoring Data, *Wat. Sci. Tech.*, 26, 1513-1524

J. B. Rose and C. P. Gerba (1991) Use of Risk Assessment for Development of Microbial Standards, *Wat. Sci. Tech.*, 24 (2), 29-34

H. Tanaka, T. Asano, E. D. Schroeder and G. Tchobanoglous (1998) Estimating the Safety of Wastewater Reclamation and Reuse Using Enteric Virus Monitoring Data, *Water Environment Research*, 70 (1), 39-51

Member organizations of Committee for reclaimed water quality:

Public Works Research Institute, Japan Sewage Works Agency, Sapporo City, Tokyo Metropolitan Government, Chiba Prefecture, Yokosuka City, Hamamatsu City, Nagoya City, Osaka City, Kobe City, Kitakyushu City and Fukuoka City

**31. UTILIZATION OF TREATED WASTEWATER
IN SAPPORO**

Presenter

Toru Yoshioka, Sapporo Municipal Government

Sewerage Bureau

UTILIZATION OF TREATED WASTEWATER IN SAPPORO

Toru YOSHIOKA

Sapporo Sewerage Bureau
Toyohira 6-3-2-1, Toyohira-ku, Sapporo 062-8570 JAPAN

ABSTRACT

The Sapporo Sewerage Bureau (SSB) operates 9 wastewater treatment plants. Tertiary treatment (rapid sand filtration) is introduced in case of necessity, to achieve and keep environmental water quality standards in public waters. To utilize reclaimed (sand filtered + chlorine disinfected) water, SSB recycles it as landscaping water. Annual infection risk is evaluated around 10^{-2} on reference to the research results of Committee for Reclaimed Water Quality. SSB recycles secondary effluent for melting snow as well.

KEYWORDS

utilization, reclaimed water, rapid sand filtration, chlorine disinfection, landscaping water, annual infection risk, secondary effluent, snow melting water

INTRODUCTION

Sapporo is the largest city in Hokkaido, Japan's northernmost island. In 1886, the Government of Hokkaido was established in Sapporo to provide leadership in politics, the economy and culture. Sapporo is now fifth largest city in Japan with a population of more than 1.8 million.

Sewage works in Sapporo began in full scale in 1926, when sewer pipes were installed for discharge of stormwater in the urban area. Environmental hygiene deteriorated with a sharp increase in population, and the river pollution progressed in 1950s. To solve these problems, an improvement and extension plan of the sewer system including wastewater treatment was developed in 1957. Extension work became active with the turning point of the Winter Olympics in 1972. The service population rate, which was under 20% in FY 1970, reached 99.3% in FY 2001, and most citizens are now using the sewer system.

Diffusion of the sewerage system also contributed to improvement in river water quality. The Toyohira River, which was once too contaminated for fish to live in, became clean enough for salmon to swim from the sea.

SSB divides the city into 9 treatment areas, and has established a wastewater treatment plant (W.T.P) in each area to conduct sewage treatment. The amount of sewage treated at the 9 W.T.Ps is $1,000 \times 10^3 \text{ m}^3 \text{ day}$ (260 m.g.d.).

NECESSITY OF ADVANCED TREATMENT

One of the roles of the sewerage system is conservation of water quality in public waters. In the case of Sapporo, sewerage facilities discharge treated wastewater into small and medium-size rivers. Because the ratio of treated wastewater to river water is expected to increase with population growth in the future, advanced treatment is introduced to achieve and keep environmental water quality standards in public waters, as well as to utilize reclaimed water for exhausted rivers and other purposes. (Fig.1)

Operation of a rapid sand filtration (tertiary treatment) commenced in 1991 at the Soseigawa Treatment Plant as a water quality conservation measure for the Barato River, which is a closed water body. The treatment capacity of rapid sand filtration is $120 \times 10^3 \text{ m}^3 \text{ day}$ (30 m.g.d.)

Advanced treatment will be further introduced in the future for wastewater treatment plants that require such treatment, while taking future river water quality fully into consideration.

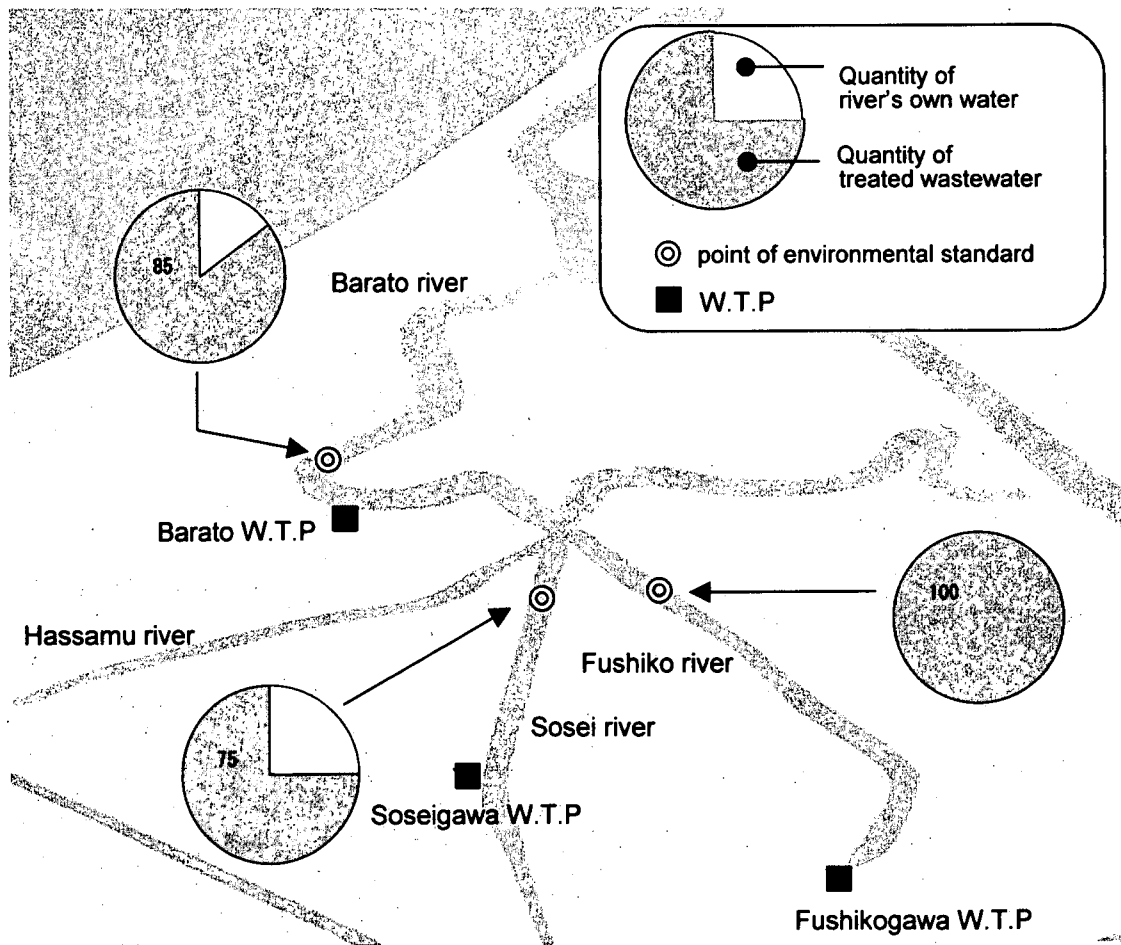

Fig.1 Treated wastewater ratio to river water

EXAMPLES OF UTILIZING TERTIARY EFFLUENT

Utilization for Landscaping Water

The Yasuharu River is a historic drainage channel excavated for turning wetland into farmland by farmer-soldiers who came to Hokkaido more than 100 years ago. The river was, however, exhausted as residential areas increased with the progress of urbanization. Under the theme of "promenade to remember the hardship of our ancestors," streams have been recovered since 1992 by introducing tertiary effluent from the Soseigawa Wastewater Treatment Plant, and afforestation and establishment of a promenade along the channel were promoted to add relaxation and comfort to the citizens' lives. (Fig.2 - 4)

Tertiary effluent has also been introduced to Tonden, Higashitonden and Barato Kohoku rivers since 1998 to recover clear streams and to utilize as water for extinguishing fires. (Fig.5)

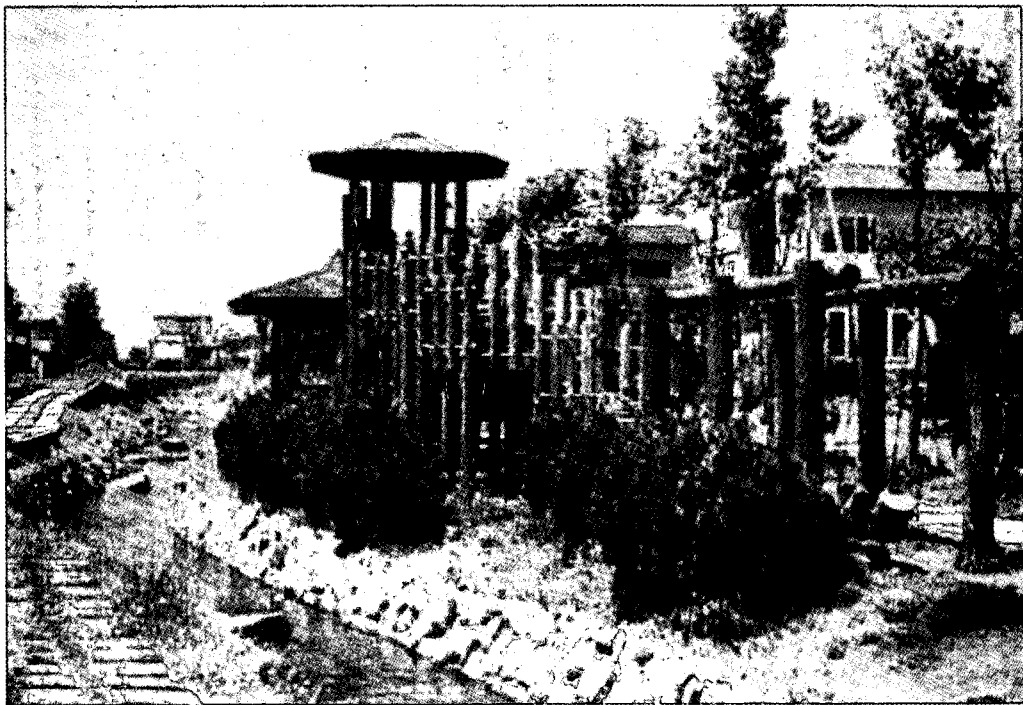

Fig.2 Yasuharu River after improvement



Fig.3 Spillway of reclaimed water
(sand filtered + chlorine disinfected)
to Yasuharu River

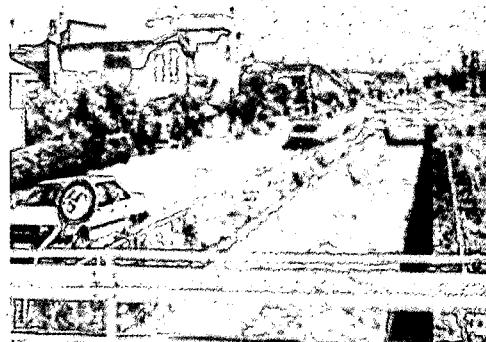
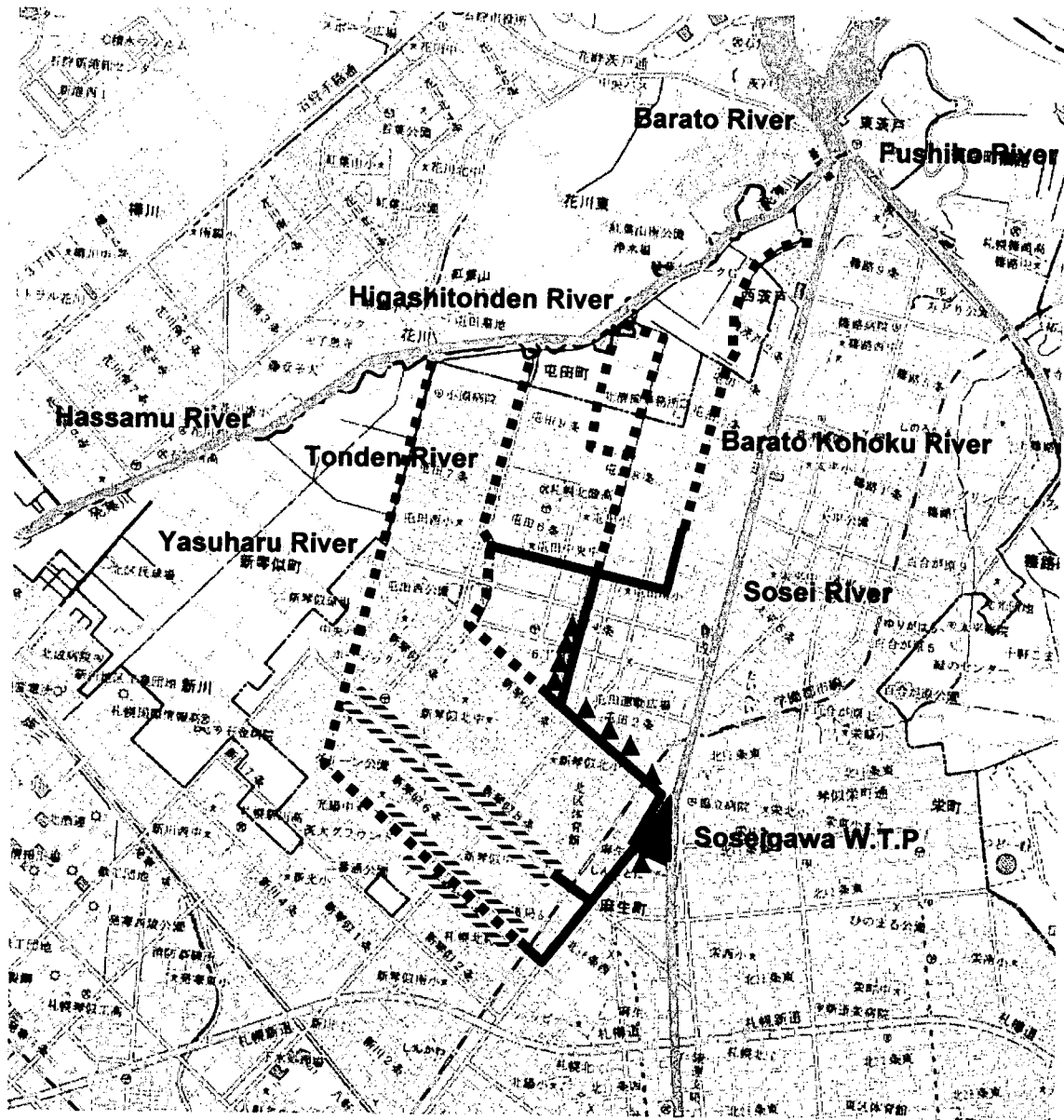

Fig.4 Yasuharu River
before improvement







reference	
	reclaimed water pipe
	river (reclaimed water)
	snow-flowing conduits
	underground fire hydrant

Fig.5 Utilization of reclaimed water

Annual Infection Risk of the Yasuharu River

Reclaimed water, sand filtered and chlorine disinfected at the Soseigawa Treatment Plant, is conveyed to the Yasuharu River by means of pump. Chlorine dosage at the Soseigawa Treatment Plant is less than 5 mg/l.

SSB takes samples from surface water in the Yasuharu River 2 times in a month from May to November, and analyzes the samples. Sample points are starting point and 600 m down point (the end of promenade area) in the Yasuharu River.

The results in August are shown in Table 1.

Table 1 Water quality of the Yasuharu River

		Starting Point			600 m Point		
		Aug. 9th 2001	Aug. 23rd 2001	average	Aug. 9th 2001	Aug. 23rd 2001	average
Residual chlorine (mg/l)	Total	1.1	0.5	0.8	0.3	0.2	0.3
	Free	0.7	0.2	0.5	0.1	0	0.08
C-BOD (mg/l)		0.1	0.8	0.7			—
Turbidity		0.7	1.7	1.2			—
Chromaticity		9.4	8.2	8.8			—
Odor		non	Slite smell of chlorine	—			—
Total Coliforms MF method		0	1	1			—
Total Coliforms per ml		0	6	3	10	26	18

blank: No data.

SSB surveyed enteric virus (Hep-2) in 1997 and in 1998. Table 2 shows the enteric virus (Hep-2) removal ratio and Fig.6 shows the enteric virus (Hep-2) concentrations of each sample.

Table 2 Enteric virus (Hep-2) removal ratio

Water Sample	Aug. 3rd.1998			Oct.27th.1997		
	Enteic virus conc. (MPN/l)	Removal Ratio (%)	Log Removal (log10)	Enteic virus conc. (MPN/l)	Removal Ratio (%)	Log Removal (log10)
W.P.T influent	1,743.5			262.6		
Secondary effluent	15.7	96.8%	1.50	20.9	95.2%	1.32
Tertiary effluent (Sand filtration effluent)	4.1			6.1		
[Chlorine Disinfection] 3 - 5 mg/l						
Starting Point of Yasuharu River	0.5			1.0		
600 m Point of Yasuharu River	1.0			0		

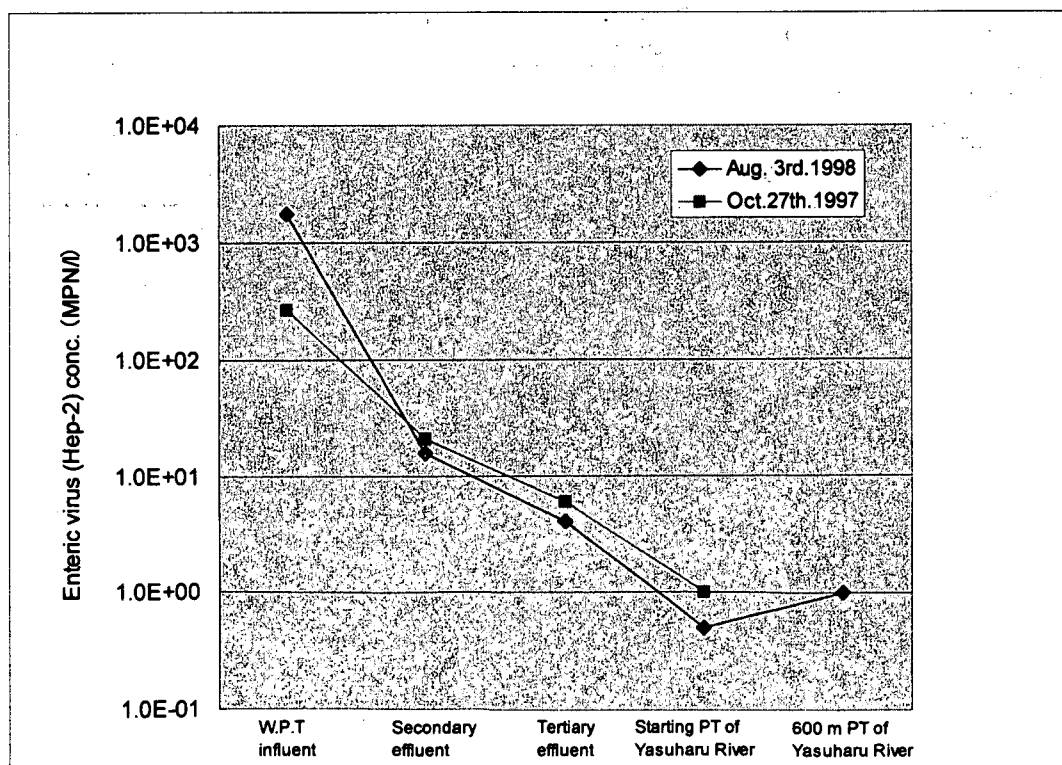

Fig.6 Enteric virus (Hep-2) concentrations in water samples

On reference to Fig.7 which is shown by Committee for Reclaimed Water Quality, the annual infection risk of the Yasuharu River is evaluated around 10^{-2} .

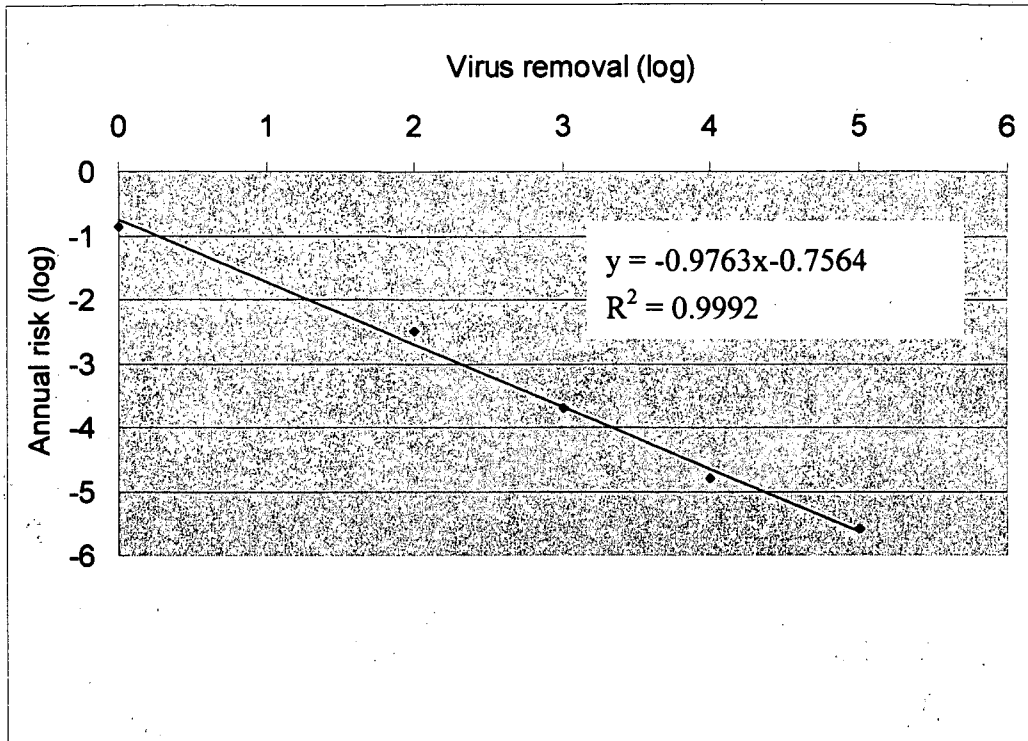

Fig.7 Relationship between virus removal efficiency and annual risk of infection (Recreational pond or stream, possible to bathe feet and hands)

EXAMPLES OF UTILIZING SECONDARY EFFLUENT

Utilization for Snow Melting Water

The average accumulation of snow in Sapporo is 4.5 m. (Fig.8) As snow falling on an urban area makes the living space smaller and has great influence on urban activities, snow measures are becoming a serious issue.

The City of Sapporo has been promoting a variety of measures to solve snow problems. Snow measures using thermal energy of secondary effluent and sewerage facilities are playing important roles in such measures.

In the sewerage system, efforts are being made to establish facilities to send secondary effluent to snow-flowing conduits (Fig.5) and snow-melting tanks using sewerage facilities (Fig.9) and conduct other measures.



Fig.8 Sapporo in winter



Fig.9 Snow-melting tank
using sewerage facilities

CONCLUSION

Sewerage functions have been improved for more than 70 years since the first sewerage plan was launched in 1926 to support the city from underground as part of urban infrastructure. Today, environmental problems have been attracting global attention. Under these circumstances, sewerage assumes a fundamental role in the water cycle.

We are committed to actively contributing to global environmental preservation and promoting sewerage projects (such as utilizing treated wastewater) under the guiding principles of leaving assets to future generations so that they can boast of their “comfortable city.”

32. Research in Water Reuse

Presenter

Stephen T. Hayashi, Union Sanitary District

Water Environment
Research Foundation

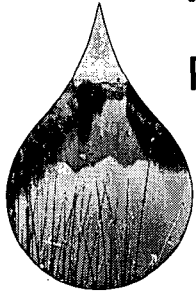
Research in Water Reuse

Stephen T. Hayashi
Chairman, Board of Directors
Water Environment
Research Foundation

Water Reuse Research Drivers

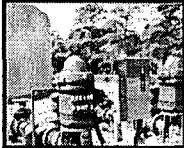

Non-potable uses
already occurring



Attention
focused on
conserving
and reusing
existing water
sources

Potable reuse will
have to meet
regulatory standards



WERF Reuse Research Areas



Treatment for Reuse



Microbial Detection and Risk Assessment

Chemical Contaminants



Communication and Public Outreach

Treatment for Reuse

How can treatment processes be modified or developed to yield water for subsequent reuse?

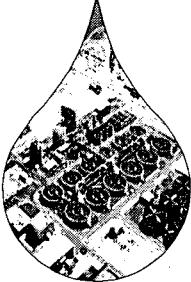

Treatment for Reuse

Completed Projects

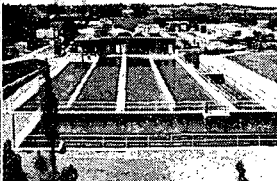

Membrane Bioreactors

Impact of Surface Storage

Treatment for Reuse

Ongoing Projects

Advanced Membrane Treatment



Treatment for Reuse



Developing design standards and guidance on distribution systems

Looking at how these effluents can be used to prevent saltwater intrusion

WERF Reuse Research Areas

Treatment for Reuse



Microbial Detection and Risk Assessment

Chemical Contaminants



Communication and Public Outreach

Microbial Detection and Risk Assessment

What new tools can be developed for on-line monitoring of pathogens and indicators?

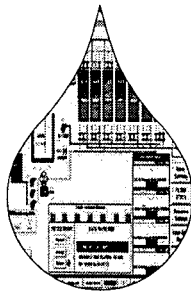

Microbial Detection and Risk Assessment

- PCR/RT-PCR
- Microarrays
- Molecular Beacon
- Microorganism removal and inactivation during water reclamation
- Evaluation of Microbial Risk Assessment Techniques

Ten completed and ongoing projects looking at new molecular detection techniques for use in water and wastewater

Ongoing Projects

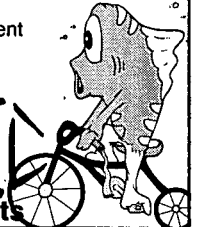

Microbial Detection and Risk Assessment

Future research



Continue to focus on the development of analytical tools

WERF Reuse Research Areas

Treatment for Reuse



Microbial Detection and Risk Assessment

Chemical Contaminants



Communication and Public Outreach

Chemical Contaminants

Are there better tools for measuring or anticipating chemical toxicity in effluent and reclaimed water?

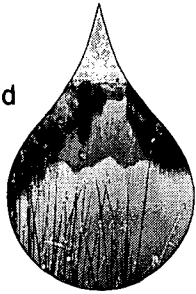

Chemical Contaminants

Ongoing Projects

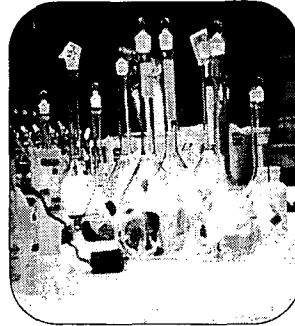

- *Two projects evaluating effects of endocrine disrupting chemicals and pharmaceuticals in reclaimed water
- *New initiative on developing on-line methods for toxicological monitoring

Chemical Contaminants

Focus on the issue of emerging contaminants such as endocrine disrupting compounds and pharmaceuticals

Future research



WERF Reuse Research Areas

Treatment for Reuse



Microbial Detection and Risk Assessment

Chemical Contaminants



Communication and Public Outreach

Communication and Public Outreach

How do we best synthesize the vast amount of data and information on chemical and microbial constituents

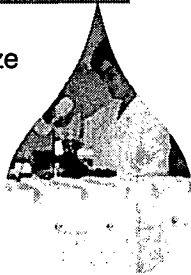

Communication and Public Outreach



Completed Projects

Communication and Public Outreach

What new insights and tools are needed to work effectively with the public? And how can you apply these tools in building a public outreach program?

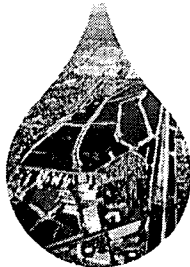

Communication and Public Outreach

Completed Projects

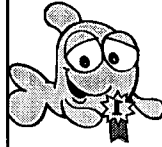

Understanding Public Perception and Participation

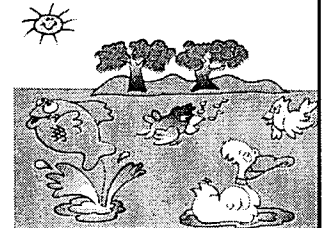

Communication and Public Outreach

Future research

Developing and applying the tools needed to implement successful public outreach programs for water reclamation projects



Additional Research is being conducted by the American Water Works Association Research Foundation.

AwwaRF Water Reuse Research

Completed Projects

- Endocrine Disruptors and Pharmaceuticals in Drinking Water
- Soil Treatability Pilot Studies
- Salinity Removal Technologies



AwwaRF Water Reuse Research

Ongoing Projects

- Assessment of Source and Drinking Waters for EDCs
- Soil-Aquifer Treatment
- Recharge of Deep Aquifers
- Water Quality Requirements for Various Applications of Reclaimed Water
- Characterizing Microbial Water Quality
- Evaluation of Treatment Processes for EDCs and Pharmaceuticals Salinity Contributions in Reclaimed Water Distribution System
- Large-Scale Desalination



AwwaRF Water Reuse Research

Future research

- ◆ The Value of Water
- ◆ Enhancing Communications on Drinking Water Issues
- ◆ Sustainable Water Supply Planning

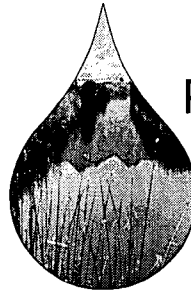
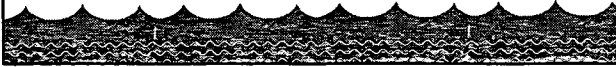

Research in Water Reuse

執筆者一覧

執筆者	担当部分
【日本側：下水道分野】	
曾小川久貴 (国土交通省都市・地域整備局下水道部長)	Welcome speech (別添5)
藤木 修 (国土交通省都市・地域整備局下水道部流域管理官)	発表論文 2
松原 誠 (国土交通省都市・地域整備局下水道部下水道企画課長補佐)	監修
宮原 茂 (国土交通省国土技術政策総合研究所下水道研究部長)	監修
高橋正宏 (国土交通省国土技術政策総合研究所下水道研究部下水道研究官)	発表論文 10
森田弘昭 (国土交通省国土技術政策総合研究所下水道研究部下水道研究室長)	本編 1～8, 発表論文 7
山下洋正 (国土交通省国土技術政策総合研究所下水道研究部下水処理研究室主任研究官)	発表論文 15
田嶋 淳 (国土交通省国土技術政策総合研究所下水道研究部下水処理研究室主任研究官)	本編 5.2
斎野秀幸 (国土交通省国土技術政策総合研究所下水道研究部下水処理研究室研究官)	本編 5.6, 5.8
山縣弘樹 (国土交通省国土技術政策総合研究所下水道研究部下水道研究室研究官)	本編 5.4, 5.5
鈴木 穰 (独立行政法人土木研究所材料地盤研究グループ上席研究員〔リサイクル〕)	発表論文 30
田中宏明 (独立行政法人土木研究所水循環研究グループ上席研究員〔水質〕)	発表論文 18
佐藤元志 (独立行政法人土木研究所水循環研究グループ招聘研究員〔水質〕)	監修
南山瑞彦 (独立行政法人土木研究所材料地盤研究グループ主任研究員〔リサイクル〕)	本編 5.14
佐々木稔 (独立行政法人土木研究所水循環研究グループ主任研究員〔水質〕)	本編 5.11, 5.12
岡安祐司 (独立行政法人土木研究所水循環研究グループ研究員〔水質〕)	本編 5.9
渡部春樹 (日本下水道事業団技術開発部長)	発表論文 23
竹島 正 (東京都下水道局業務部排水指導課長)	発表論文 26
吉岡 亨 (札幌市下水道局建設部計画課技術開発担当課長)	発表論文 31
【日本側：水道分野】	
谷津龍太郎 (厚生労働省健康局水道課長)	発表論文 1
岸辺和美 (厚生労働省健康局水道課水道水質管理官)	発表論文 4
眞柄泰基 (北海道大学大学院工学研究科教授)	発表論文 6
国包章一 (国立保健医療科学院水道工学部長)	発表論文 9, 17
安藤正典 (国立医薬品食品衛生研究所環境衛生化学部長)	発表論文 12
遠藤卓郎 (国立感染症研究所寄生動物部長)	発表論文 14
林 秀樹 ((財)水道技術研究センター浄水技術部長)	発表論文 22
山崎章三 ((財)日本水道協会特別会員)	発表論文 28
牧田嘉人 (東京都水道局総務部副参事〔特命担当〕)	発表論文 20
佐々木隆 (阪神水道企業団管理部配水課長)	発表論文 25
【米国側】	
Mrs. Sally C. Gutierrez (USEPA 国立リスク管理研究所)	発表論文 3
Dr. James A. Goodrich (USEPA 国立リスク管理研究所)	発表論文 27
Ms. Kathleen Schenck (USEPA 国立リスク管理研究所)	発表論文 19
Dr. Stephen W. Clark (USEPA)	発表論文 21
Dr. Jennifer McLain (USEPA)	発表論文 5
Mr. James F. Manwaring (米国水道協会研究財団)	発表論文 11
Mr. Peter Cook (米国民営水道事業者協会)	発表論文 29
Mr. Jung Choi (フィラデルフィア市水道局)	発表論文 16
Mr. Edmund G. Archuleta (エルパソ市水道公社)	発表論文 13
Mr. Stephen T. Hayashi (ユニオン地区衛生公社)	発表論文 32
Prof. John Thomas Novak (バージニアポリテクニク州立大学)	発表論文 24
Mr. Tyler Richards (ジョージア州ギネット郡公共事業局)	発表論文 8

(役職は2002年10月時点のもの)

国土技術政策総合研究所資料
TECHNICAL NOTE of NILIM
No.123 SEPTEMBER 2003

土木研究所資料
TECHNICAL MEMORANDUM of PWRI
No.3912 SEPTEMBER 2003

編集・発行 ©国土技術政策総合研究所
©土木研究所

本資料の転載・複写の問い合わせは
〒305-0804 茨城県つくば市旭1番地
国土技術政策総合研究所 企画部研究評価・推進課
TEL 029-864-2675

又は
〒305-0803 茨城県つくば市南原1番地6
独立行政法人土木研究所 企画部業務課
TEL 029-864-2675